

Effect of Biodiesel on Emissions from a Tier 2 Marine Propulsion Engine

**Final Report (Revised)
November 2009**

Prepared for:

Mr. Todd Sterling
California Air Resources Board
1001 I Street, Sacramento, CA 95814

Contract #06-412



Authors:

Ms. Varalakshmi Jayaram
Dr. J. Wayne Miller
Mr. Harshit Agrawal
Mr. William A Welch
Dr. David R Cocker

University of California, Riverside
College of Engineering-Center for Environmental Research and Technology
Riverside, CA 92521

Disclaimer

This report was prepared as the result of work sponsored by the California Air Resources Board (CARB) and carried out with a major ferry/excursion company. As such the report does not necessarily represent the views of CARB and the partnering shipping company. Further the collective participants, its employees, contractors and subcontractors make no warrant, express or implied, and assume no legal liability for the information in this report; nor does any party represent that the uses of this information will not infringe upon privately owned rights. This report has neither been approved nor disapproved by the collective group of participants nor have they passed upon the accuracy or adequacy of the information in this report.

Acknowledgements

The authors would like to thank California Air Resources Board for their financial support without which this project would not have been possible. A special thanks to the ferry crew and administrative staff aboard the vessel for their logistical support during testing of one the main propulsion engines. The authors would like to acknowledge Mr. Charles Bufalino's efforts in the test preparation and Mr. Kurt Bumiller for his help in developing the data acquisition system. We are deeply grateful of the support offered by Mr. Virgilio Afan, Ms Kathalena Cocker, Mr. James Theodore Gutierrez, Mr. Mohammad Yusuf Khan, and Dr. Sindhuja Ranganathan of the analytical laboratory at CE-CERT in the preparation and analysis of the sample media.

Table of Contents

Disclaimer	ii
Acknowledgements	iii
Table of Contents	iv
List of Figures	vi
List of Tables	vii
Executive Summary	viii
1. Introduction	1
1.1. Project Objective.....	1
2. Test Plan	2
2.1. Overview	2
2.2. Test Engine	2
2.3. Test Fuels	3
2.4. Test Cycle and Operating Conditions	4
2.5. Test Schedule	4
2.6. Emissions Testing Procedure	5
2.6.1. Sampling Ports	5
2.6.2. Measuring Gases and PM _{2.5} emissions	6
2.6.3. Calculating Exhaust Flow Rates from Intake Air	6
2.6.4. Calculation of Engine Load	6
2.6.5. Calculation of Emission Factors	7
3. Results	8
3.1. Fuel Properties	8
3.2. Primary Gaseous Emissions.....	8
3.2.1. CO ₂ Emission Factors	10
3.2.2. NO _x Emission Factors	11
3.2.3. CO Emission Factors	12
3.2.4. Carbon Mass Balance: Fuel Vs Exhaust.....	13
3.3. Particulate Matter Emissions	14
3.3.1. PM _{2.5} Mass Emissions.....	16
3.3.2. Elemental Carbon (EC).....	17
3.3.3. Organic Carbon (OC).....	18
3.3.4. Conservation of PM _{2.5} Mass Emissions.....	19
3.3.5. Real Time PM _{2.5} Monitoring	21
3.4. In-Use Test Cycle	22
4. Discussions	24
4.1. Comparison with Tier 2 Standards and Manufacturer’s Certification for that Engine Family	24
4.2. Steady State Test Modes	25
4.3. Actual In-Use Emissions Cycle	27
5. Summary and Recommendations	28
6. References	30
7. Glossary of Symbols and Abbreviations	31
8. Appendix A	33

8.1.	Certification Emission Test Protocol for Marine Propulsion Engines.....	33
8.2.	Protocol for Measuring Actual In-Use Emissions from Marine Propulsion Engines.....	33
8.2.1.	Measuring Criteria Gaseous Emissions	35
8.2.2.	Measuring the Particulate Matter (PM) Emissions	37
8.3.	Quality Control/Quality Assurance (QC/QA)	38
9.	Appendix B	40
10.	Appendix C	42
11.	Appendix D	45

List of Figures

Figure 2-1: Test Engine	3
Figure 2-2: Test Fuels	3
Figure 2-3 Sampling Ports	5
Figure 2-4 Correlation between Engine load and CO ₂ emissions.....	7
Figure 3-1 Carbon-dioxide (CO ₂) Emissions (g/hr).....	10
Figure 3-2 CO ₂ Emission Factors (g/hp-hr).....	10
Figure 3-3 Nitrogen-oxide (NO _x) Emissions (g/hr)	11
Figure 3-4 NO _x Emission Factors (g/hp-hr).....	11
Figure 3-5 Carbon-monoxide (CO) Emissions (g/hr).....	12
Figure 3-6 CO Emission Factors (g/hp-hr)	12
Figure 3-7 Carbon Mass Balance between Fuel and Exhaust.....	13
Figure 3-8 Total Particulate Matter (PM) Emissions (g/hr)	16
Figure 3-9 Total PM Emission Factors (g/hp-hr)	16
Figure 3-10 Elemental Carbon Emissions (g/hr)	17
Figure 3-11 Elemental Carbon Emissions (g/hp-hr).....	17
Figure 3-12 Organic Carbon Emissions (g/hr).....	18
Figure 3-13 Organic Carbon Emissions (g/hp-hr)	18
Figure 3-14 PM _{2.5} Mass Balance	19
Figure 3-15 PM _{2.5} Mass Balance for B0.....	20
Figure 3-16 PM _{2.5} Mass Balance for B20.....	20
Figure 3-17 PM _{2.5} Mass Balance for B50.....	20
Figure 3-18 Correlation between PM _{2.5} Reference to DustTrak in Dilute Exhaust for B0	21
Figure 3-19 Correlation between PM _{2.5} Reference to DustTrak in Dilute Exhaust for B20	21
Figure 3-20 Correlation between PM _{2.5} Reference to DustTrak in Dilute Exhaust for B50	22
Figure 3-21 Approximate Trace of a Typical Cruise in the Bay	22
Figure 3-22 Real-Time Emissions Trace for Typical Cruise in the Bay	23
Figure 4-1 Overall Weighted Average Emission Factors for Gases and Total PM _{2.5}	25
Figure 8-1 Partial Flow Dilution System with Single Venturi, Concentration Measurement and Fractional Sampling	34
Figure 8-2 Field Processing Unit for Purifying Dilution Air in Carrying Case.....	35
Figure 8-3 In-Field Illustration of Continuous Gas Analyzer and Computer for Data Logging.....	36

List of Tables

Table 2-1 Selected Test Engine Specifications.....	2
Table 2-2 Test Schedule.....	5
Table 3-1 Selected Fuel Properties	8
Table 3-2 Gaseous Emission Factors (g/hr).....	9
Table 3-3 Gaseous Emission Factors (g/hp-hr)	9
Table 3-4 Total and Speciated Particulate Matter (PM _{2.5}) Emissions (g/hr)	15
Table 3-5 PM _{2.5} Emission Factors (g/hp-hr).....	15
Table 4-1 Comparison of Weighted Emission Factors in g/hp-hr	24
Table 8-1 Five Mode Test Cycle for Heavy-Duty Marine Engines (ISO-8178-E-3 test cycle).....	33
Table 8-2 Detector Method and Concentration Ranges for Monitor	37
Table 8-3 Quality Specifications for the Horiba PG-250	37

Executive Summary

Background: California Air Resources Board (CARB), a ferry/excursion company and University of California, Riverside worked together under a contract to measure the actual in-use emissions of gases (CO₂, CO, NO_x) and particulate matter (PM_{2.5}) mass from a modern U.S. EPA Tier 2 marine engine while operating on ultra low sulfur CARB diesel and determine the emissions benefits if any of switching to biodiesel blends. For this purpose a 500hp 4-stroke, high speed marine propulsion engine was tested on three fuels CARB ultra low sulfur diesel (B0) and blends of a soy based biodiesel with CARB ultra low sulfur diesel (B20 and B50).

Methods: Emissions testing was conducted over a three day time period in February of 2009. Gaseous emissions of carbon dioxide (CO₂), nitrogen oxide (NO_x), carbon monoxide (CO) and total and speciated PM_{2.5} mass emissions were measured based on the ISO 8178-1 protocol following the load points in the ISO 8178 E3 cycle. The boat spends a significant amount of time idling, therefore, the idle mode was also tested. Real-time in-use emissions were measured for a typical cruise in the San Francisco Bay.

Results: The overall weighted emission factors in g/hp-hr for a greenhouse gas CO₂ and the criteria pollutants NO_x, CO and total PM_{2.5} mass emissions are shown in Figure ES-1. The figure shows that the test engine meets the Tier 2 emissions standard and is a representative engine for the analysis presented in this report. Modal data in g/hr and g/hp-hr is provided in the body of the report.

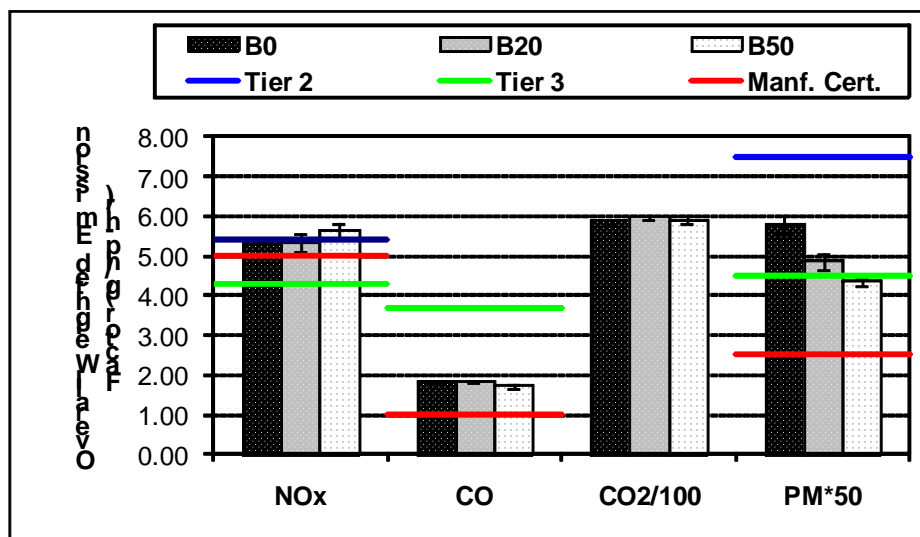

Note: Tier 2 and Tier 3 Standards on the NO_x bars represent NO_x + THC standard

Manf. Cert.: Manufacturer's Certification for the Engine Family

Figure ES- 1 Overall Weighted Average Emission Factors for Gases and Total PM_{2.5}

No significant change in CO₂ and NO_x emission factors across engine load or fuels was observed. The overall weighted average CO emissions factor shows a 7% decrease with B50 and no significant change with B20.

A 25% reduction in overall weighted average total PM_{2.5} mass emission factor was observed with B50; B20 showed 16% reduction. The reduction in total PM_{2.5} mass can be attributed to the decrease in overall weighted emission factors for EC (B20 14%, B50 42%) and OC (B20 23%, B50 27%) fractions of the PM_{2.5} mass (Figure ES-2). The nature of the PM_{2.5} mass was significantly different for B50 compared to B20 and B0 as B50 showed a higher OC/EC ratio across all engine loads.

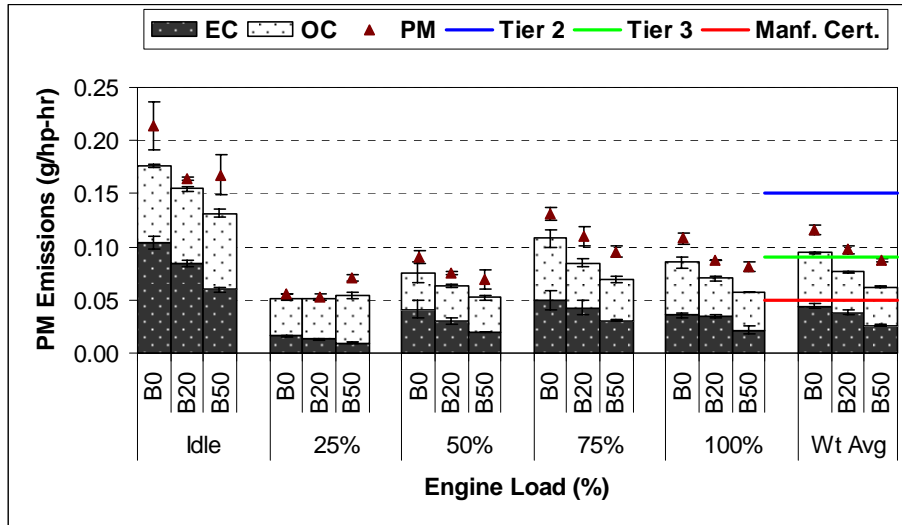

Manf. Cert.: Manufacturer's Certification for the Engine Family, *Wt Avg:* Overall Weighted Average

Figure ES- 2 Total and Speciated PM_{2.5} Emission Factors

In addition to testing at the certification cycle engine loads, real-time gaseous (NO_x, CO, CO₂) and PM_{2.5} emissions were measured during a cruise in the bay. This data showed that for a particular speed of the boat, the ocean currents produce a significant effect on the load of the engine, resulting in a three fold increase in NO_x and CO₂, thirteen fold increase in CO and a five fold increase in the total PM_{2.5} mass emissions.

Conclusions

- Modern marine Tier 2 engines have low in-use emissions.
- Adding biodiesel to diesel fuel will lower the PM_{2.5} emissions. A 50% blend of biodiesel with diesel reduces the overall weighted average PM_{2.5} emission factor by 25%, thereby facilitating the attainment of the Tier 3 PM_{2.5} emission standard.
- Speciation of the PM_{2.5} mass emissions showed that B50 has a higher OC/EC ratio across all engine loads.
- Measurements during a typical touring cycle shows that the load strongly depended on ocean currents. So this is significant factor when establishing the average power level for a typical cycle.

1. Introduction

Over the past decade, emissions from marine sources have been the subject of increasing attention. As the on-road mobile sources of pollution have been scrutinized and controlled through regulation, other source categories, such as marine sources, have gained attention (Cooper, 2001a). Several measurement studies, mostly focusing on uncontrolled, marine diesel engines for propulsion and their NO_x , SO_2 , CO, CO_2 and HC emissions, have led to the attainment of the Lloyd's first emission data base. While most maritime air pollution comes from freight traffic, passenger ferries represent an extremely visible and fast-growing segment, making ferry emissions a new and important issue for air quality management (Farrell, 2000). A comprehensive study of Boston Harbor conducted by Cooper, 2001b indicated that ferries accounted for 23% of SO_x emissions, 2% of PM emissions, 13% of hydrocarbon (HG) emissions, and 8% of NO_x emissions.

Ferry companies, acting in response to a demand for faster and more frequent ferry service, have expanded and modernized their fleets at both the federal and state levels (California Department of Finance; 2000a,b). Rising roadway congestion has also motivated plans for passenger ferry expansion and modernization in many parts of the US. However, to realize this potential, the ferry industry must meet several challenges associated with growth, including environmental impacts (Federal Highway Administration (FHWA), 1999; Perata, D., 1999). In particular, concern over air pollution emissions from marine engines is motivating new comparisons between ferries and other transportation modes in terms of both mobility and air pollution. Farrell projected increased emissions from the expanded ferry system proposed for the San Francisco Bay Area, showing that a larger ferry fleet could become a major non-road NO_x sources in the region.

In the wake of this expansion in fleet, the maritime industries are continually seeking and implementing emission abatement strategies (Götze, 1999; Klock, 1997). Effects of this development are already evident as exemplified by the increased use of various devices as a means for reducing exhaust NO_x and PM emissions.

1.1. Project Objective

The primary objectives of this project were

- To compare the actual in-use emissions of gases (CO_2 , CO, NO_x ,) and particulate matter ($\text{PM}_{2.5}$) mass from a modern Tier 2 marine engine while operating on ultra low sulfur CARB diesel with the certification values.
- To measure the effect of biodiesel blends on the in-use emissions from a modern Tier 2 marine diesel engine.

For this purpose one of the two propulsion engines on a ferry was tested on three fuels ultra low sulfur CARB diesel (B0), and two blends of biodiesel B20 and B50. In-use emissions of a greenhouse gas (CO_2), and criteria pollutants that include oxides of nitrogen (NO_x), carbon monoxide (CO) and particulate matter ($\text{PM}_{2.5}$) were measured.

2. Test Plan

2.1. Overview

Emission measurements on diesel engines are normally performed in a test cell where the engine is mounted on an engine dynamometer. For this project the measurements were made on an in-use engine on-board a harbor-craft. One of two propulsion engines on the harbor-craft was tested on three fuels B0, B20 and B50. Testing were performed based on the ISO 8178-1 protocols following the load points on the ISO 8178 E3 cycle.

Testing in the field added complexity to the project. A detailed testing plan was developed ahead of time for this purpose. This involved moving a suite of equipment on-board the harbor-craft, finding sampling ports on the engine exhaust, setting up the laboratory, calibrating the instruments and measuring the emissions within the limited period provided by the ferry/excursion company. The ISO test protocol had to be modified where necessary to accommodate safety and operational considerations of the harbor-craft.

A pre-test inspection was conducted aboard the vessel during which UCR worked with the ship's engineering crew to locate the utilities necessary for operating the sampling systems and determine sites on the engine exhaust for installation of sampling ports. Further, a detailed plan and schedule for testing was developed and finalized with the Chief Engineer.

This section provides: (a) information on the test engine, test fuels, test cycle and test schedule; (b) a brief description of the emissions testing procedures. Additional details on the testing procedures can be found in Appendix A.

2.2. Test Engine

The harbor-craft used during the test program was powered by two propulsion engines and two auxiliary engines. One of the two propulsion engines was chosen as the test engine. Details of the same are provided below in Table 2-1. The test engine is a Category 1 marine engine with a U.S. EPA Tier 2 emissions certification.

Table 2-1 Selected Test Engine Specifications

Manufacturer /Model	Cummins QSK19-M
Manufacture Year	2007
Technology	4-Stroke
Serial Number	32015540
Max. Power Rating	500 hp
Rated Speed	1900 rpm
# of Cylinders	6
Engine Displacement	18.9 liters

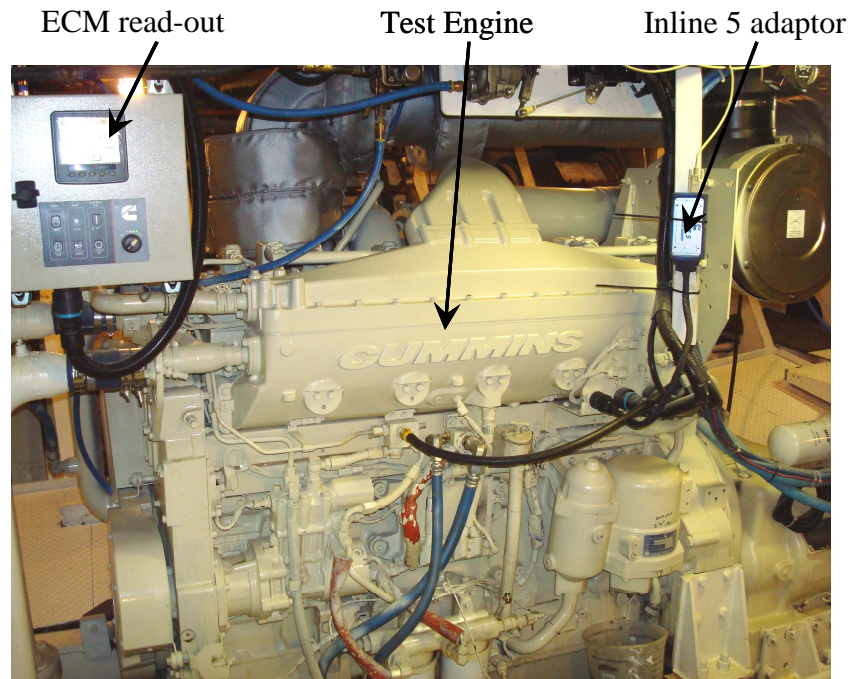

Figure 2-1: Test Engine

Engine parameters including engine speed, engine load, intake manifold pressure, intake air temperature and fuel flow rate were recorded from the engine electronic control module (ECM) using the Cummins Inline 5 adaptor and Insite software.

2.3. Test Fuels

The primary goal of the test program was to determine the effects of biodiesel on emissions from the marine engine.

Three fuels were chosen for this purpose.

- Ultra low sulfur CARB diesel (B0)
- A blend of 20% biodiesel with 80% ultra low sulfur diesel (B20)
- A blend of 50% biodiesel with 50% ultra low sulfur diesel (B50)

A soy based biodiesel was used for this project. All three fuels were typical of normal supply. Selected properties of the test fuels are discussed in Section 3.1.

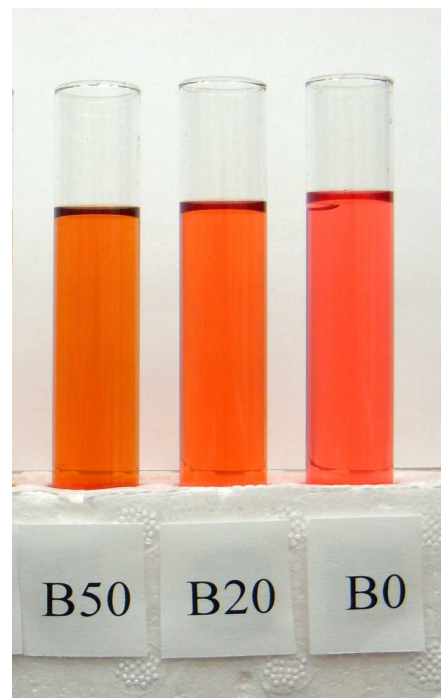

Figure 2-2: Test Fuels

2.4. Test Cycle and Operating Conditions

Gaseous and PM_{2.5} emissions were measured based on the ISO 8178-1 protocols at test modes specified in the ISO 8178 E3 cycle for certification of heavy duty marine engines. Details of the engine load and speed at the test modes is provided in Table 8-1 in Appendix A. Besides these modes the engine was tested while idling in gear as this forms a significant part of the actual in-use operation of the engine. Also, real time gaseous and PM measurements were made during a typical cruise in the bay.

On the day prior to testing the test engine was mapped on B50 fuel to determine if all the modes in the test plan could be achieved. The initial plan was to attain the load points in the test cycle at the dock while the harbor-craft pushed against the pier. As a result of propeller cavitation, only the lowest engine load point of 25% was achievable with this setup. Therefore the test plan was altered and the engine was tested while the harbor-craft sailed in the bay.

Since, B50 has a lower energy density than B0, the ISO target load of 100% could not be achieved. The resulting maximum load attained with B50 was 94% of the maximum rated power of the engine. To maintain uniformity and reduce uncertainty in the comparison of emissions across fuels, the other two fuels (B20 and B0) were tested at the 94% load instead of the 100% load. All other load points in the test plan were achieved while in the water.

Due to practical considerations, the actual engine load at each test mode could differ by a factor of $\pm 5\%$ from the ISO target load.

At each steady state test mode the protocol requires the following:

- Allowing the gaseous emissions to stabilize before measurement at each test mode.
- Measuring gaseous and PM concentrations for a time period long enough to get measurable filter mass
- Recording engine RPM, displacement, boost pressure and intake manifold temperature in order to calculate the mass flow rate of the exhaust.

2.5. Test Schedule

The test program was conducted over a three day period from the 23rd to 25th of February 2009. The first day involved: installing sampling ports at the appropriate locations in the exhaust, setting up the laboratory on-board the harbor-craft, calibrating the testing equipment and recording the engine map when the engine operated on the B50 fuel.

Emissions measurements were made on the subsequent days as per the schedule are provided in Table 2-2. The design of the test matrix helped account for errors in emissions measurements that would occur from both repeatability and reproducibility of the test cycle.

Table 2-2 Test Schedule

Date	Fuel	Engine Loads
07/24/2009	B50	<i>RT & ISO:</i> 100%, 75%,50%,25%, Idle
	B0	<i>RT & ISO:</i> 100%, 75%,50%,25%, Idle
	B50	<i>RT & ISO:</i> 100%, 75%, 50%, 25%
	B20	<i>RT & ISO:</i> 100%, 75%, 50%, 25%, Idle
07/25/2009	B20	<i>RT & ISO:</i> 100%, 75%, 75%, 50%, 25%, Idle
	B50	<i>RT & ISO:</i> 100%, 75%, 75%, 50%, 25%, Idle
	B0	<i>RT & ISO:</i> 100%, 75%, 75%, 50%, 25%, Idle
	B20	<i>RT:</i> Typical cruise of harbor-craft in the bay

RT: Real Time Monitoring and Recording of Gaseous Emissions

ISO: Filter Samples taken in accordance with ISO 8178-4 E3

2.6. Emissions Testing Procedure

The emissions testing of the propulsion engine was performed using a partial dilution system that was developed based on the ISO-8178-1 protocols. This section gives a brief description of this testing procedure. Refer to Appendix A for further details.

2.6.1. Sampling Ports

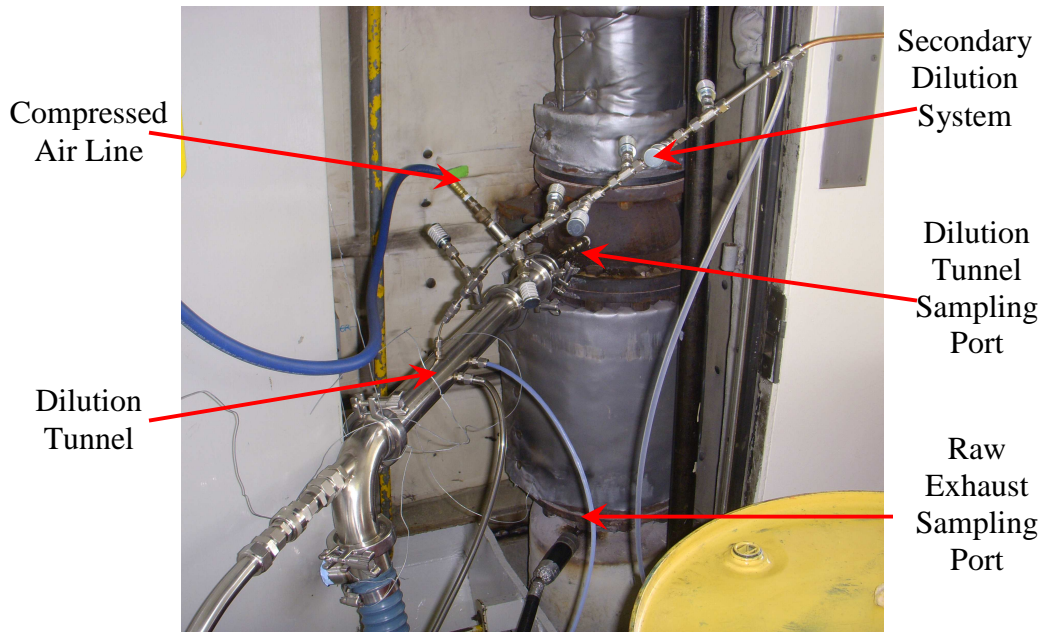

Figure 2-3 Sampling Ports

Two sampling ports were installed in the exhaust stack on the day prior to testing. One port was used for the dilution tunnel and the other for the raw exhaust sampling. The sample probes, 3/8” stainless steel tubing, extended about 6” into the raw exhaust stack

(18" diameter). This distance is sufficiently away from any effects found near the exhaust stack wall.

2.6.2. Measuring Gases and PM_{2.5} emissions

The concentrations of carbon dioxide (CO₂), nitrogen oxide (NO_x) and carbon monoxide (CO) were measured both in the raw exhaust and the dilution tunnel with a Horiba PG-250 portable multi-gas analyzer (Appendix A, Section 8.2.1).

Particulate matter (PM_{2.5}) was sampled from the dilution tunnel on Teflo® and Quartz filters. These filters were analyzed to determine the total and speciated PM_{2.5} mass emissions (Appendix A, Section 8.2.2).

A continuously data acquisition system was used to log real time measurements of gaseous and PM emissions and flows through the Teflo® and Quartz filters.

2.6.3. Calculating Exhaust Flow Rates from Intake Air

An accurate calculation of the exhaust gas flow rate is essential for calculating emission factors. For this project the exhaust gas flow rate was calculated as equal to the flow of intake air. This method is widely used for calculating exhaust flow rates in diesel engines and assumes the engine is an air pump, so the flow of air into the engine will be equal to the exhaust flow out of the engine. The flow rate of intake air is determined from the cylinder volume, recorded rpm, and the temperature and pressure of the inlet air. The method works best for four stroke engines or for two-stroke engines where there the scavenger air flow is much smaller than the combustion air. The propulsion engine selected for this test program was a 4-stroke diesel engine.

2.6.4. Calculation of Engine Load

The actual load on the engine at each test modes is required to calculate the modal and overall emission factors in g/hp-hr. The engine ECM provides engine speed and the percentage of the maximum engine load at that speed. This data was used along with the lug curve provided by the manufacturer for that engine family (Appendix C) to determine the actual load in hp for each test mode.

The lug curve as seen in Appendix C does not provide load data for speeds below 800rpm. The speed of the engine while operating at Idle mode was determined to be 650rpm. To determine the actual load on the engine in hp at this mode a plot of CO₂ emissions in g/hr versus the load in hp at all other load points was made. As seen in Figure 2-4, all three fuels showed extremely good correlations between load and CO₂ emissions. These correlations were used to estimate the engine load at the Idle modes.

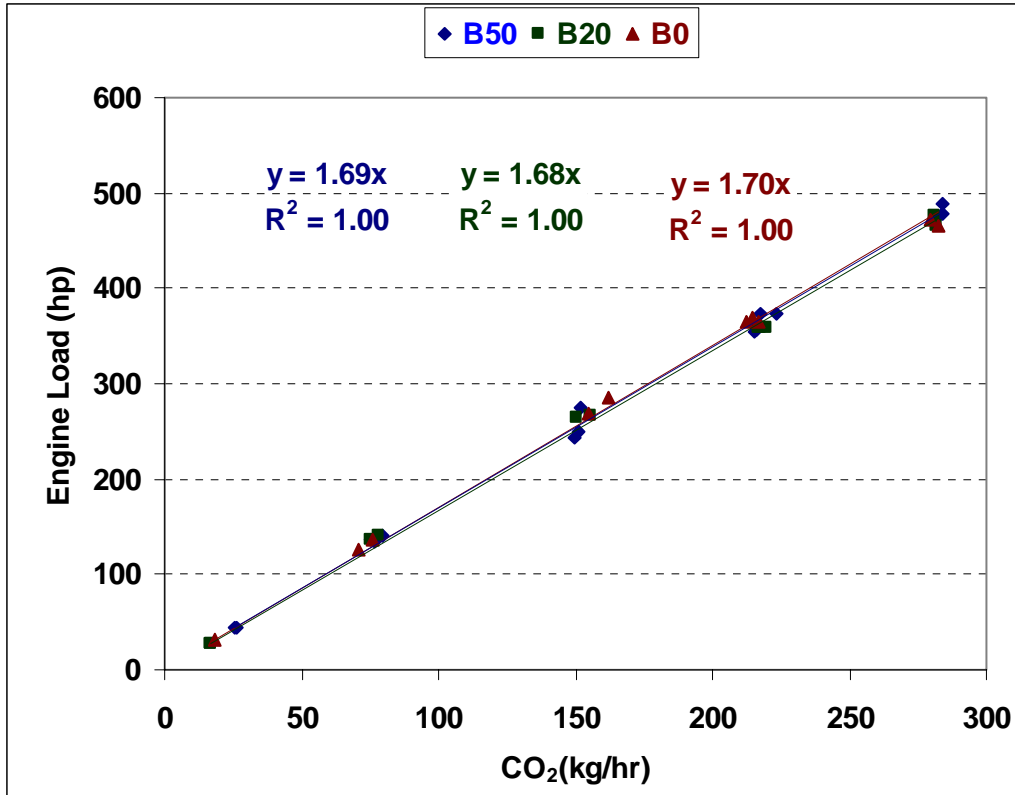

Figure 2-4 Correlation between Engine Load and CO₂ Emissions

2.6.5. Calculation of Emission Factors

The emission factor at each mode is calculated from the measured gaseous and PM_{2.5} concentration, the reported engine load in horsepower (hp) and the calculated mass flow in the exhaust.

An overall single emission factor representing the engine is determined by weighting the modal data according to the ISO 8178 E3 requirements and summing them. The equation used for the overall emission factor is as follows:

$$A_{WM} = \frac{\sum_{i=1}^{i=n} (g_i \times WF_i)}{\sum_{i=1}^{i=n} (P_i \times WF_i)}$$

Where:

A_{WM} = Weighted mass emission level (CO, CO₂, PM_{2.5}, or NO_x) in g/hp-hr

g_i = Mass flow in grams per hour,

P_i = Power measured during each mode, and

WF_i = Effective weighing factor.

3. Results

3.1. Fuel Properties

The primary goals of this project were to measure emissions from an in-use modern Tier 2 marine engine and determine the effects biodiesel on emissions from modern Tier 2 marine diesel engines. For this purpose three fuels were chosen, the first being the baseline ultra low sulfur CARB diesel B0, and the other two (B20 and B50) were blends of biodiesel with B0. All three fuels were typical of normal supply. Selected properties of the fuels are provided below in Table 3-1. The certificate of analysis provided by the fuel supplier and results of fuel analysis are presented in Appendix B.

Table 3-1 Selected Fuel Properties

Fuel	API Gravity @ 60°F	Density @ 25°C (kg/m³)	Volume % of Methyl Ester
B0	37.2	838.4	n/a
B20	35.3	848.1	22.6
B50	33.1	859.0	46.4

n/a: not applicable

3.2. Primary Gaseous Emissions

The primary gaseous emissions measured during this test program include a greenhouse gas carbon dioxide (CO₂), and the criteria pollutants: nitrogen oxides (NO_x), carbon monoxide (CO)). Each of these gaseous species was measured using the IMO standard instrumentation (Section 8.2.1). A detailed list of the modal gaseous emissions in g/hr and g/hp-hr, for all three fuels B0, B20 and B50, is provided in Tables 3-2 and 3-3.

Triplicate readings were taken at the ISO target load of 75% which has the maximum weighing factor of 0.5 in the ISO 8178 E3 cycle. Duplicate readings were taken at all other steady state modes. Each reading was a three to five minute average of one hertz data obtained from the instrument. The standard deviation of three to five minute averages was <2% for CO₂. This indicates that the load on the engine while testing that mode was steady, thereby validating the reading at each of those test modes. The standard deviation or range across the triplicate or duplicate readings at each mode (<6% of average reading for all but CO at 100% engine load where it was ~15% of averages) is indicated by the error bars in the Figures 3-1, 3-2, 3-3, 3-4 and 3-5.

Table 3-2 Gaseous Emission Factors (g/hr)

Target Load	Actual Load			NO _x (g/hr)			CO (g/hr)			CO ₂ (kg/hr)		
	B0	B20	B50	B0	B20	B50	B0	B20	B50	B0	B20	B50
Idle	6%	6%	9%	190	171	296	36	32	44	18	17	26
25%	26%	28%	27%	683	719	742	71	63	63	74	77	77
50%	55%	53%	51%	1338	1291	1320	255	204	171	159	153	151
75%	73%	72%	73%	1944	1900	2005	973	999	955	215	218	218
100%	94%	94%	96%	2654	2597	2756	439	403	298	281	281	283

Table 3-3 Gaseous Emission Factors (g/hp-hr)

Target ISO Load	Actual Load			NO _x (g/hp-hr)			CO (g/hp-hr)			CO ₂ (g/hp-hr)		
	B0	B20	B50	B0	B20	B50	B0	B20	B50	B0	B20	B50
Idle	6%	6%	9%	6.2	6.1	6.7	1.20	1.15	1.00	588	595	592
25%	26%	28%	27%	5.2	5.2	5.4	0.54	0.46	0.46	560	557	564
50%	55%	53%	51%	4.8	4.9	5.2	0.92	0.77	0.67	573	576	589
75%	73%	72%	73%	5.3	5.3	5.5	2.66	2.78	2.62	586	607	599
100%	94%	94%	96%	5.7	5.5	5.7	0.94	0.86	0.62	601	598	589
Overall Weighted Average				5.33	5.35	5.63	1.84	1.85	1.72	588	597	591
% Reduction of Overall Weighted Average Compared to B0				n/a	n.s.	n.s.	n/a	n.s.	7%	n/a	n.s.	n.s.

n/a not applicable, n.s. not significant

3.2.1. CO₂ Emission Factors

A comparison of the CO₂ emissions factors across different test modes and fuels are presented in Figures 3-1 and 3-2. The small error bars in the figure representing the standard deviation or range of the measurements show good repeatability and reproducibility of the test cycle. The emissions in g/hr increase with load due to increase in fuel consumption. As expected the g/hp-hr emissions are flat across load points and fall within the typical range of CO₂ emission factors for four-stroke, high speed diesel engines.

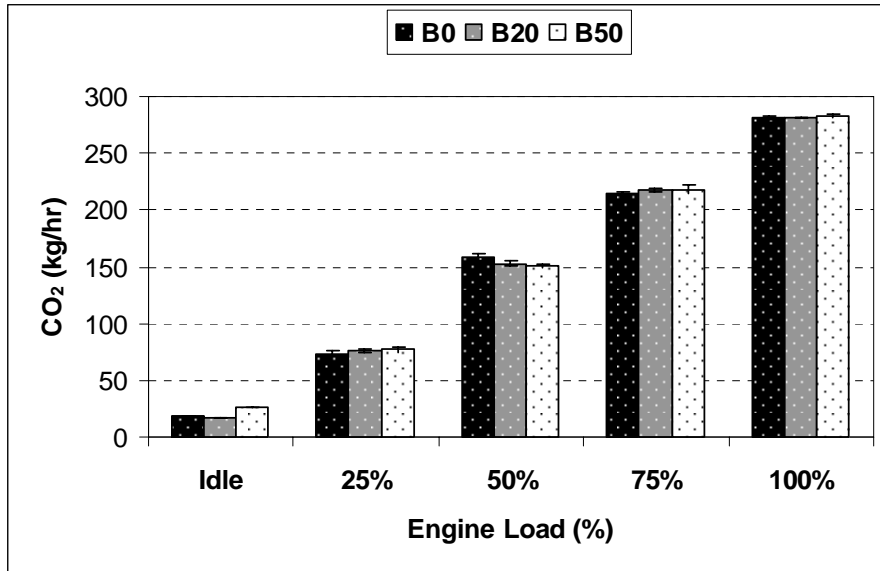
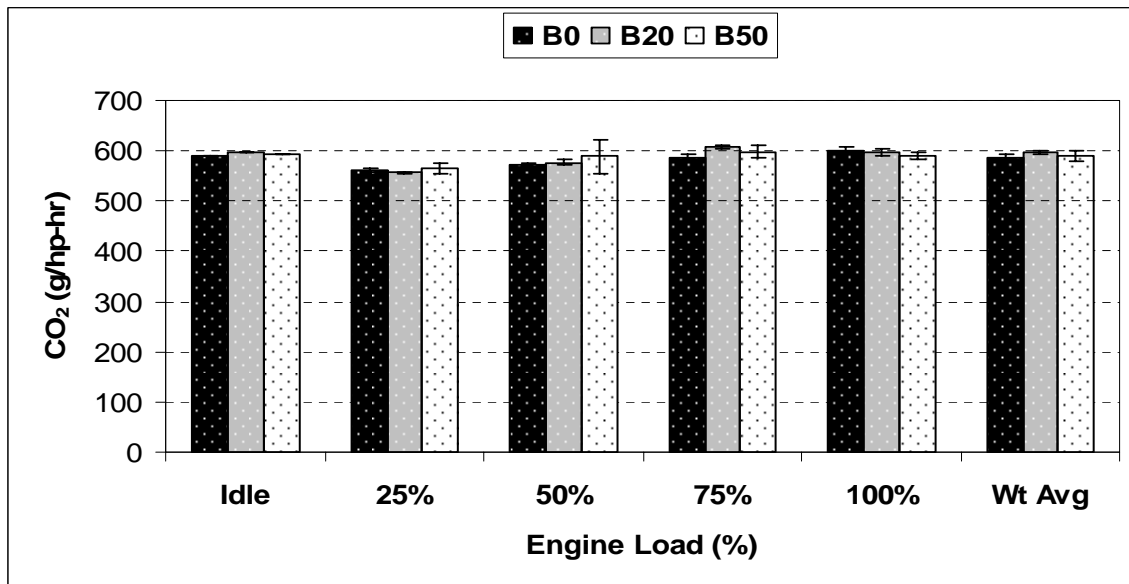

Figure 3-1 Carbon-dioxide (CO₂) Emissions (g/hr)



Wt Avg: Overall Weighted Average
Figure 3-2 CO₂ Emission Factors (g/hp-hr)

3.2.2. NO_x Emission Factors

The NO_x emissions in g/hr and g/hp-hr are presented in Figures 3-3 and 3-4. The NO_x emissions in g/hr follow the CO₂ emissions increasing with load. The emission factors in g/hp-hr are flat across the engine loads. There is no significant change in NO_x emissions across fuels. The NO_x weighted emission factor for B0 is 5.33 ± 0.04 g/hp-hr, which is close to the Tier 2 standard for NO_x + THC of 5.4 g/hp-hr.

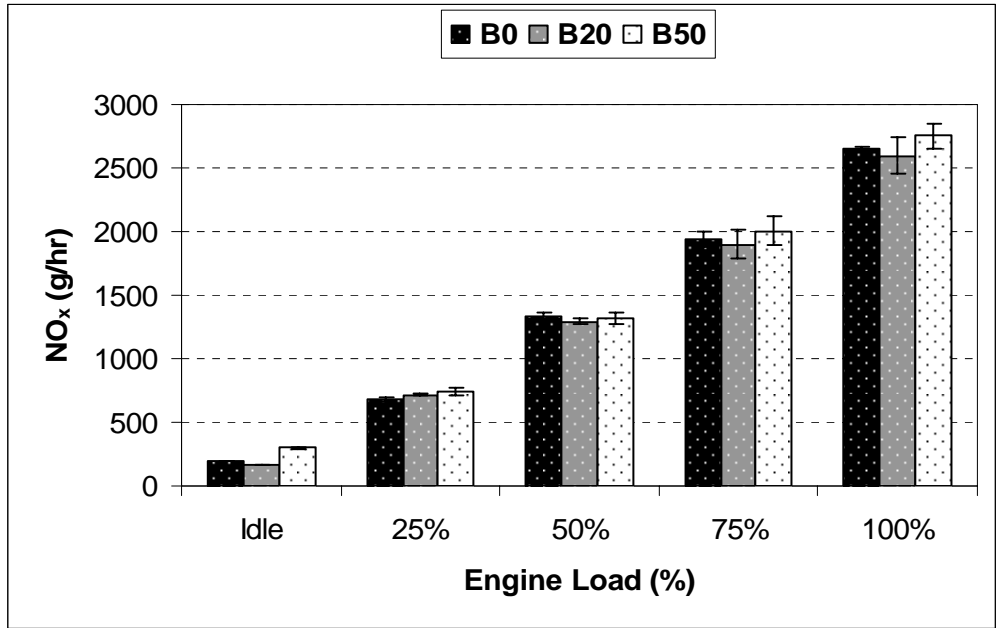
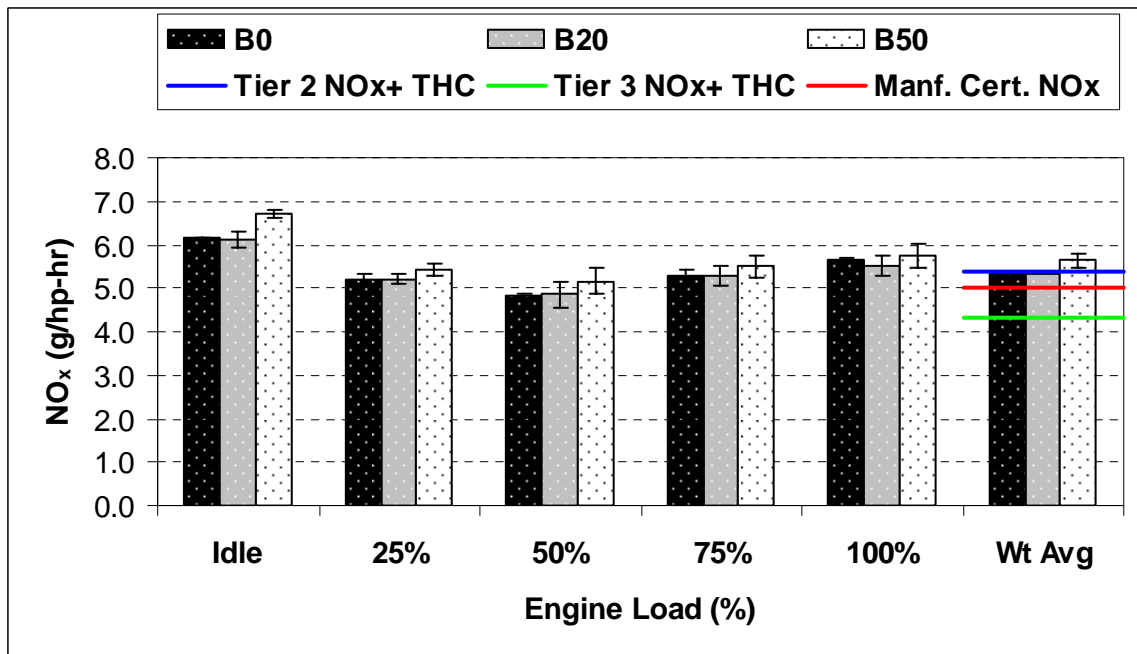

Figure 3-3 Nitrogen-oxide (NO_x) Emissions (g/hr)



Manf. Cert.: Manufacturer's Certification for the Engine Family, *Wt Avg:* Overall Weighted Average

Figure 3-4 NO_x Emission Factors (g/hp-hr)

3.2.3. CO Emission Factors

Figures 3-5 and 3-6 show the CO emissions factors across the different steady state test modes for all three fuels B0, B20 and B50. There was a spike in the CO emissions at the 75% load point where the concentration of CO in the exhaust was as high as 490 ppm. A 15% to 36% reduction in CO emission factors was observed by switching from B0 to B50 at all test modes except 75% engine load point. This translates to a 7% decrease in overall weighted average CO emission factor.

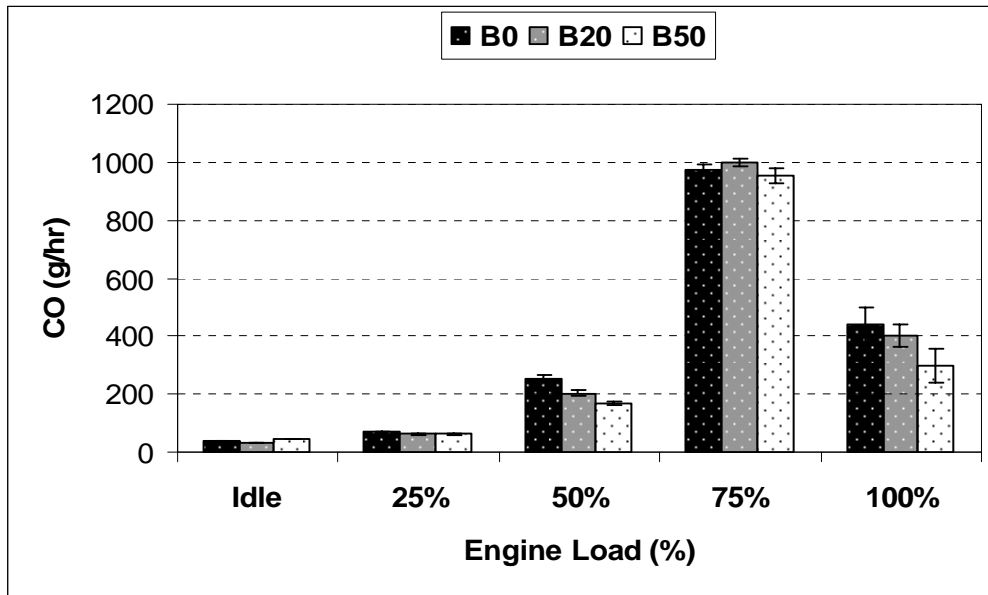
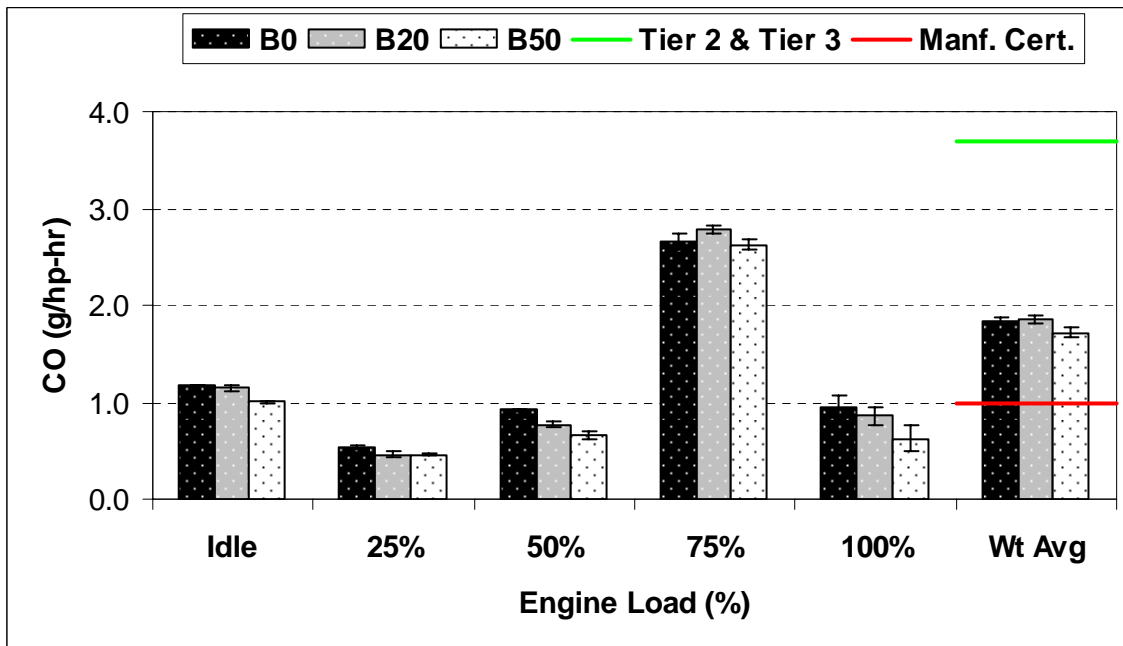

Figure 3-5 Carbon-monoxide (CO) Emissions (g/hr)



Manf. Cert.: Manufacturer's Certification for the Engine Family, *Wt Avg:* Overall Weighted Average

Figure 3-6 CO Emission Factors (g/hp-hr)

3.2.4. Carbon Mass Balance: Fuel Vs Exhaust

As a part of the UCR's QA/QC the mass balance between the carbon in the fuel and the carbon measured in the exhaust is checked. For this project the fuel flow was not directly measured, instead the instantaneous fuel flow rate in gallons per hour was logged from the engine ECM data. Graboski et al, 1998 reports the typical carbon content of diesel and methyl soyester biodiesel as 87% and 77.2%. Based on this data the carbon content of the B20 and B50 fuels was estimated. Using this carbon content and the density of fuel obtained from the fuel analysis (Appendix B) and carbon from the fuel was calculated in g/hr. About 99% of the carbon from the fuel is converted to CO₂. The amount of carbon in the exhaust was calculated from the CO₂ and CO emissions.

A plot of the carbon in the fuel versus the carbon in the exhaust for all three fuels is plotted in Figure 3-7. For B0, the ECM data was ~10% lower than the measured carbon in the exhaust. For most diesel engines the correlation between fuel flow and carbon in the exhaust will be < 2%. In this test, the fuel flow was not measured. The engine ECM provides an estimate of the fuel flow based on other engine parameters. The discrepancy in the correlation shows a bias in this fuel flow estimation. This ECM estimate of fuel flow was probably determined using B0 as the fuel. Therefore, the correlations obtained for B20 and B50 are even farther that that for B0.

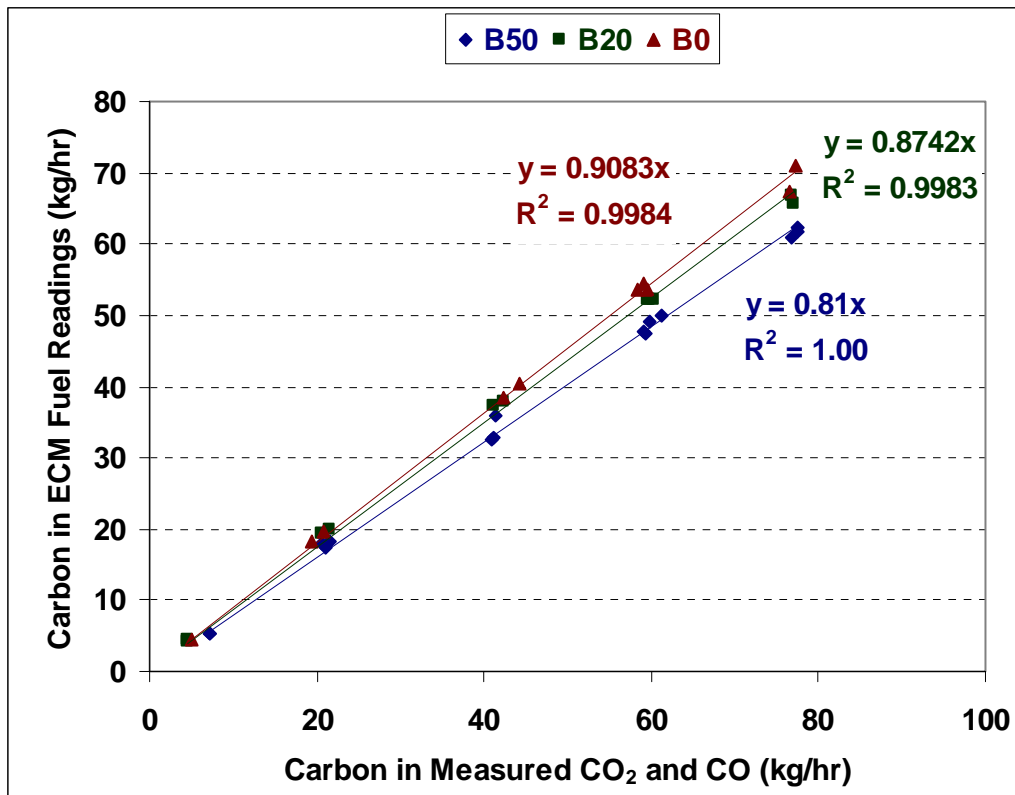

Figure 3-7 Carbon Mass Balance between Fuel and Exhaust

3.3. Particulate Matter Emissions

In addition to gaseous emissions, the PM_{2.5} mass emissions and the speciated PM_{2.5} emissions as elemental carbon (EC) and organic carbon (OC) were measured. As described earlier, the PM mass in the raw exhaust was sampled using a partial dilution method and collected on filter media. In addition, real-time PM measurements were collected using TSI's DustTrak during both steady state and transient modes. The total and speciated PM_{2.5} mass emissions in g/hr and g/hp-hr for the steady state test modes across all fuels are provided in Tables 3-4 and 3-5. As in the case of gaseous emissions, triplicate measurements were made at the 75% engine load pint and duplicate readings were made at all other test modes. The standard deviation/range of the readings is shown in the form of error bars in Figures 3-8 through 3-13.

Table 3-4 Total and Speciated Particulate Matter (PM_{2.5}) Emissions (g/hr)

Target Load	Actual Load			PM _{2.5} (g/hr)			EC (g/hr)			OC (kg/hr)		
	B0	B20	B50	B0	B20	B50	B0	B20	B50	B0	B20	B50
Idle	6%	6%	9%	6.6	4.6	7.4	3.2	2.4	2.6	2.3	2.0	3.2
25%	26%	28%	27%	7.3	7.4	9.6	2.1	1.8	1.3	4.5	5.2	6.0
50%	55%	53%	52%	25.0	20.0	17.9	11.5	8.1	5.1	9.5	8.8	8.5
75%	73%	72%	74%	48.0	39.4	35.0	18.4	15.4	11.3	21.1	15.1	14.1
100%	94%	94%	96%	50.5	41.3	38.9	16.6	16.3	10.5	23.4	16.7	17.2

Table 3-5 PM_{2.5} Emission Factors (g/hp-hr)

Target ISO Load	Actual Load			PM _{2.5} (g/hp-hr)			EC (g/hp-hr)			OC (g/hp-hr)		
	B0	B20	B50	B0	B20	B50	B0	B20	B50	B0	B20	B50
Idle	6%	6%	9%	0.214	0.164	0.168	0.103	0.084	0.060	0.073	0.071	0.072
25%	26%	28%	27%	0.055	0.053	0.070	0.016	0.013	0.010	0.035	0.037	0.044
50%	55%	53%	52%	0.091	0.075	0.069	0.041	0.031	0.020	0.035	0.033	0.033
75%	73%	72%	74%	0.131	0.110	0.095	0.050	0.043	0.031	0.058	0.042	0.038
100%	94%	94%	96%	0.108	0.088	0.081	0.035	0.035	0.022	0.050	0.035	0.036
Overall Weighted Average				0.116	0.097	0.087	0.044	0.038	0.026	0.050	0.038	0.037
% Reduction of Overall Weighted Average Compared to B0				n/a	16%	25%	n/a	14%	42%	n/a	23%	27%

n/a not applicable

3.3.1. PM_{2.5} Mass Emissions

Total PM_{2.5} mass emissions in g/hr and g/hp-hr for the steady state test modes across all fuels is presented in Figures 3-8 and 3-9. The PM_{2.5} emissions in g/hr increased with increase in engine load due to increased fuel consumption. As in the case of CO emissions, the PM emissions in g/hp-hr peaked at the 75% engine load point. An average reduction of 19% with B20 and 26% B50 compared to the baseline emissions at B0 was observed at the 50% to 100% engine load points. The weighted emission factor for B0 was found to be 0.116 ± 0.004 g/hp-hr meets the Tier 2 standard of 0.15 g/hp-hr.

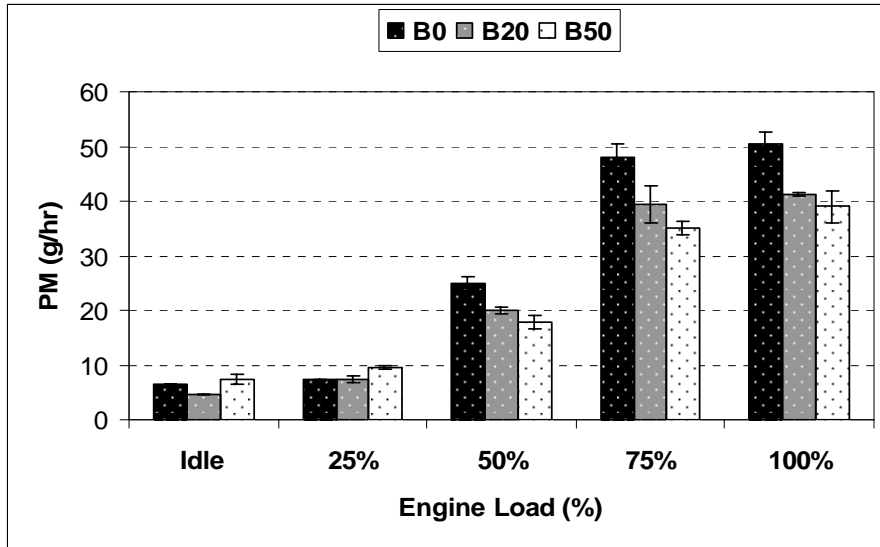
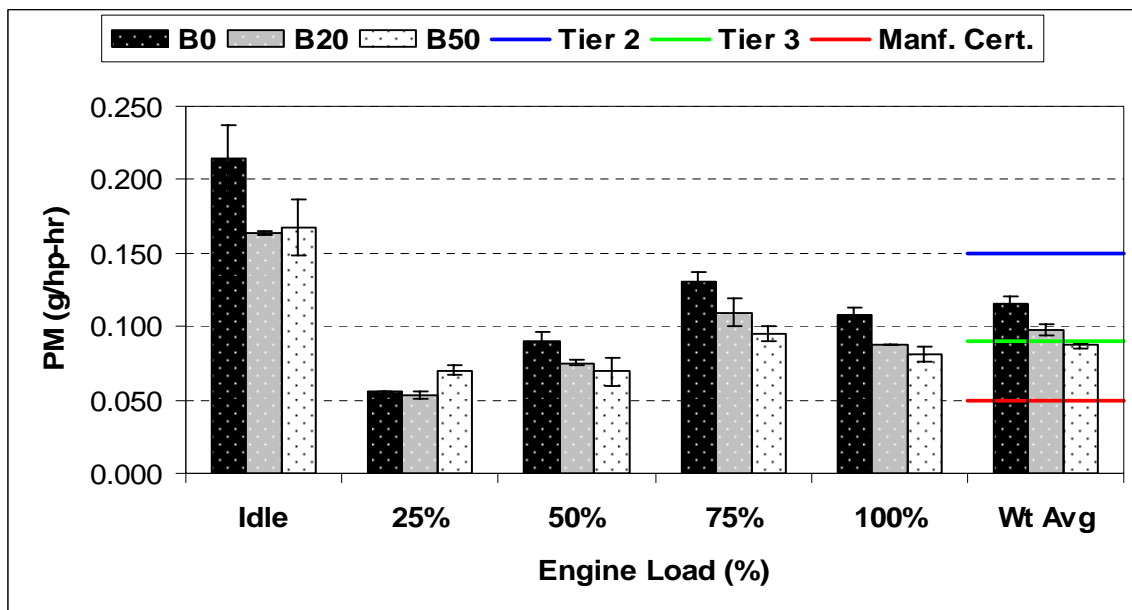

Figure 3-8 Total Particulate Matter (PM) Emissions (g/hr)



Manf. Cert.: Manufacturer's Certification for the Engine Family, Wt Avg: Overall Weighted Average
 Figure 3-9 Total PM Emission Factors (g/hp-hr)

3.3.2. Elemental Carbon (EC)

Figures 3-10 and 3-11 show the element carbon fraction of PM_{2.5} emissions in g/hr and g/hp-hr. The elemental carbon emissions in g/hp-hr follow a trace similar to the total PM_{2.5} showing a spike at the 75% load point. Also there is a reduction of elemental carbon emissions with use of B20 and B50 as compared to B0.

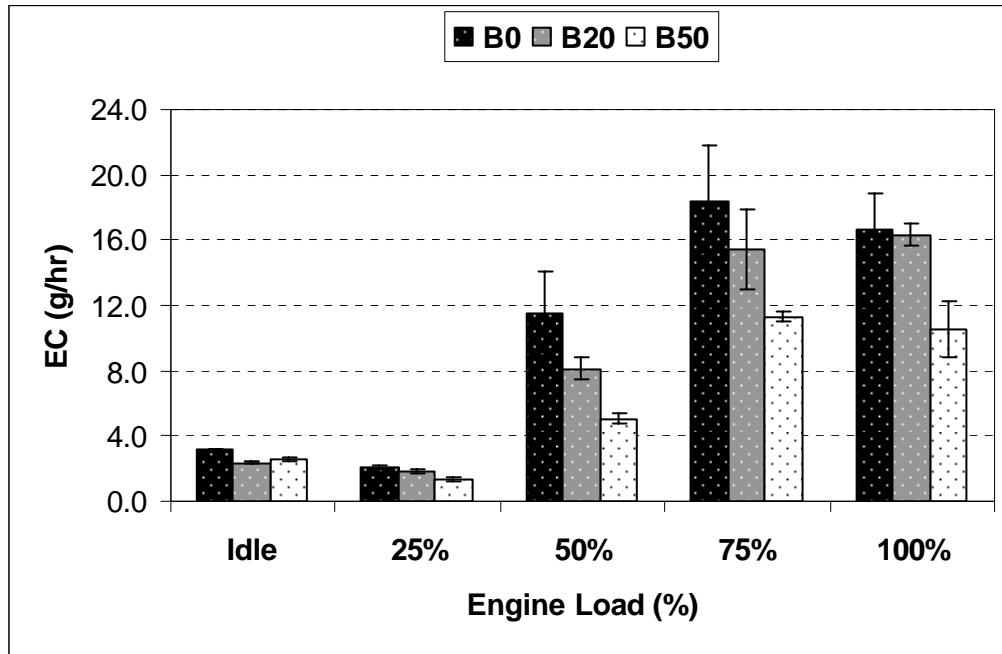
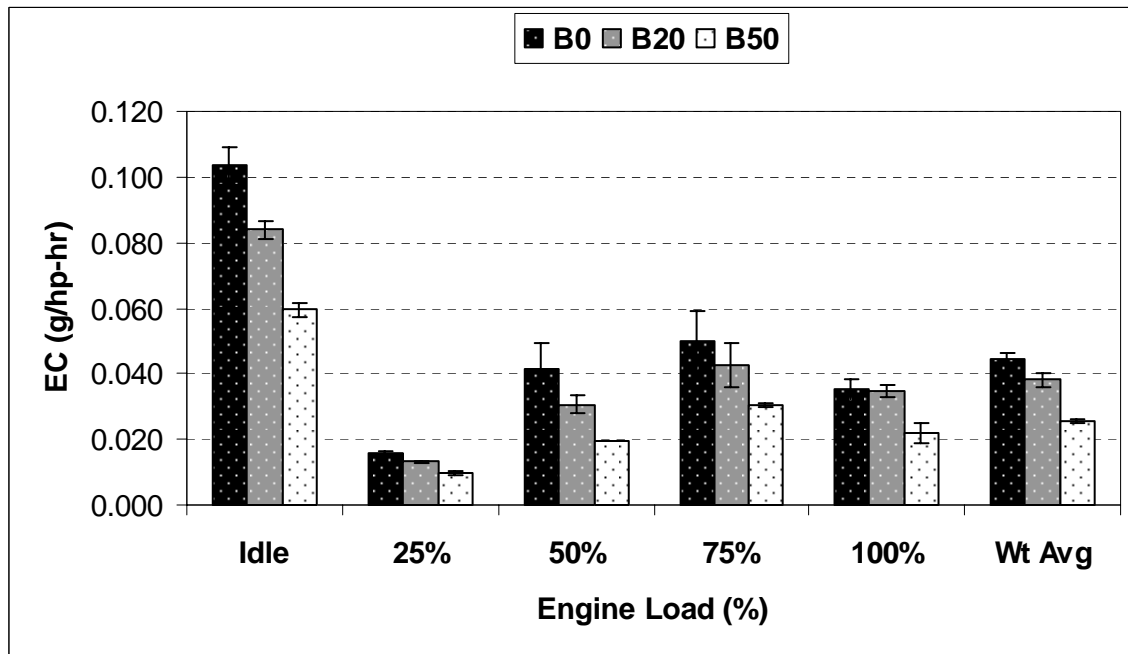

Figure 3-10 Elemental Carbon Emissions (g/hr)



Wt Avg: Overall Weighted Average

Figure 3-11 Elemental Carbon Emissions (g/hp-hr)

3.3.3. Organic Carbon (OC)

The organic carbon fraction of PM_{2.5} in g/hr and g/hp-hr across the different engine loads and fuels is presented in Figures 3-12 and 3-13. There is an increase in the organic carbon content of PM_{2.5} with the use of B20 and B50 at the lower loads. At the higher load points the opposite trend is observed.

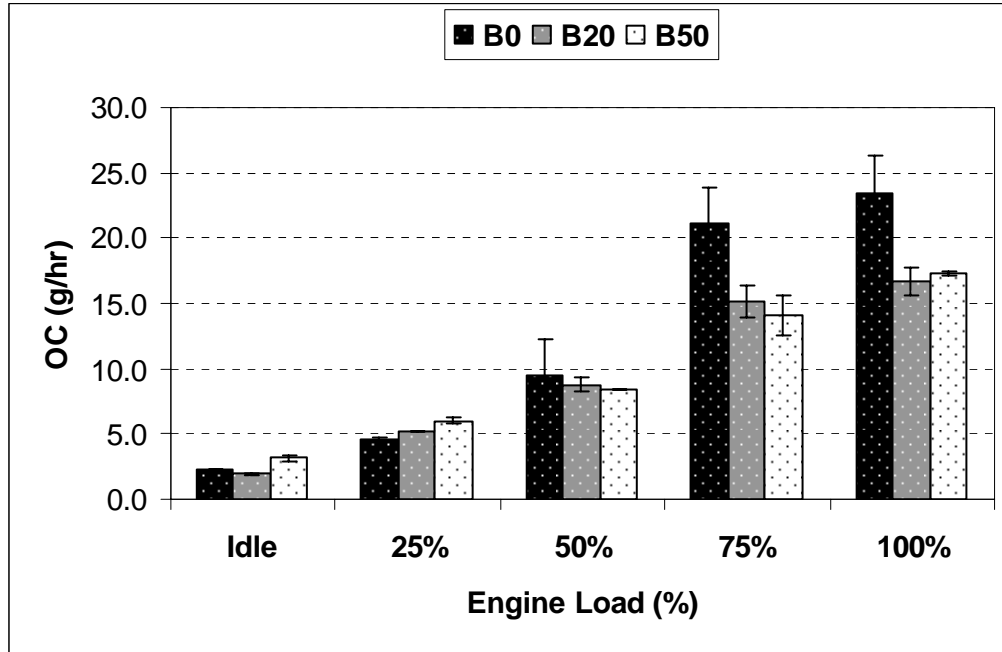
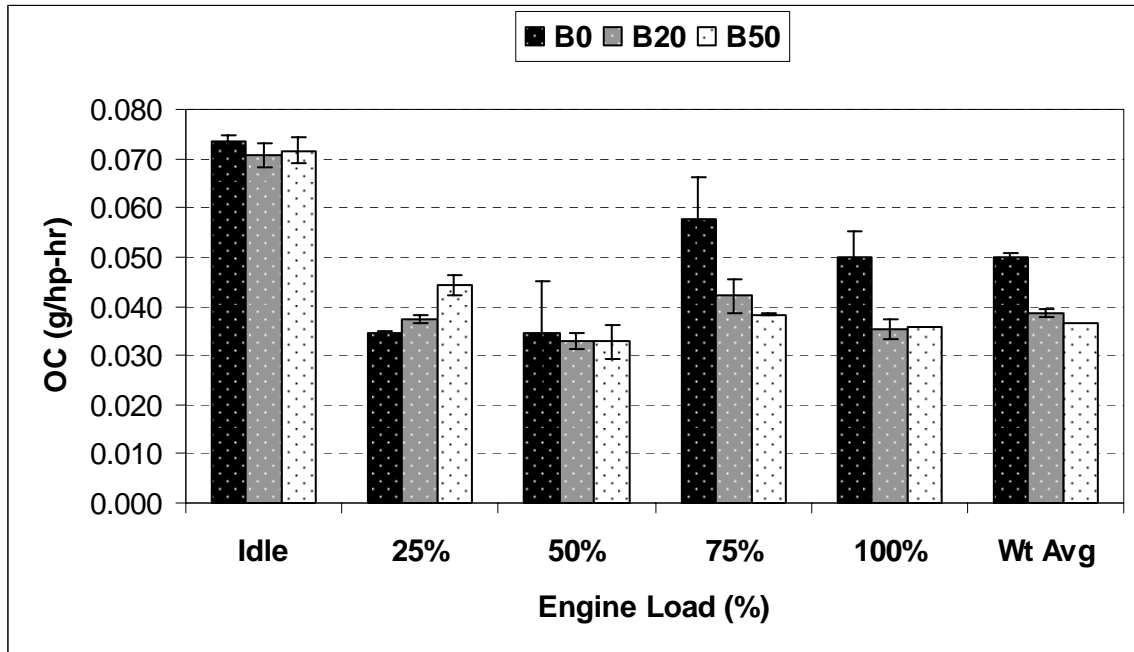

Figure 3-12 Organic Carbon Emissions (g/hr)



Wt Avg: Overall Weighted Average
 Figure 3-13 Organic Carbon Emissions (g/hp-hr)

3.3.4. Conservation of PM_{2.5} Mass Emissions

An important element of UCR's analysis approach is the QA/QC check that the total PM_{2.5} mass measured by the various PM methods are comparable. Specifically the total PM_{2.5} mass collected on the Teflo® filter is compared to the sum of the elemental and organic carbon fractions of the PM_{2.5} collected on the quartz filter. Diesel PM_{2.5} primary consists of elemental carbon, organic carbon, sulfate and ash. The diesel fuels in this test program have extremely low sulfur and ash content well below the detection limits.

A comparison of the total and speciated PM_{2.5} mass emissions for different fuels is shown in Figures 3-14 through 3-17. As expected the sum of EC+OC is less than that of total PM_{2.5} mass. The OC fraction of PM_{2.5} has to be multiplied by a factor to account of the other elements like H, O, etc that make this fraction up. The mass balance presented in the figures is reasonable and increases the confidence in the test results.

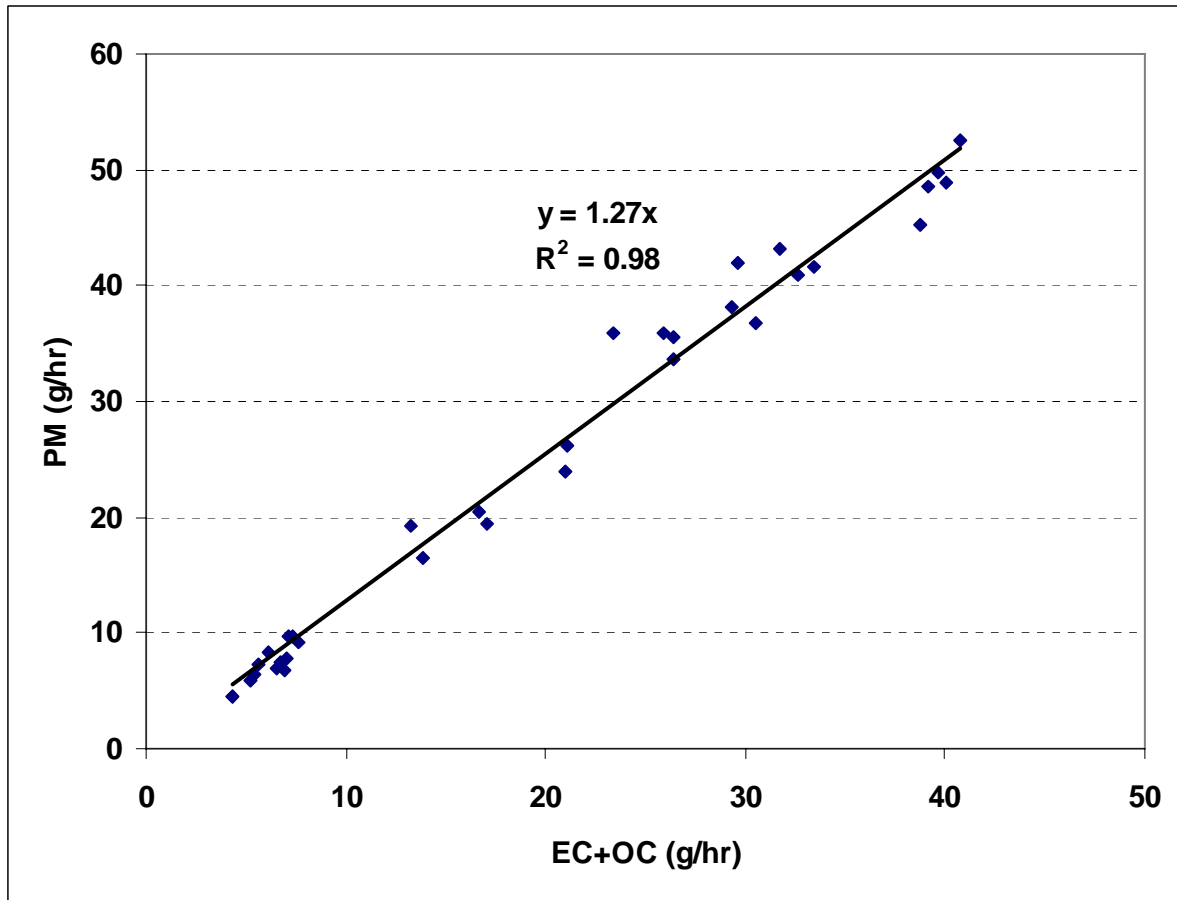

Figure 3-14 PM_{2.5} Mass Balance

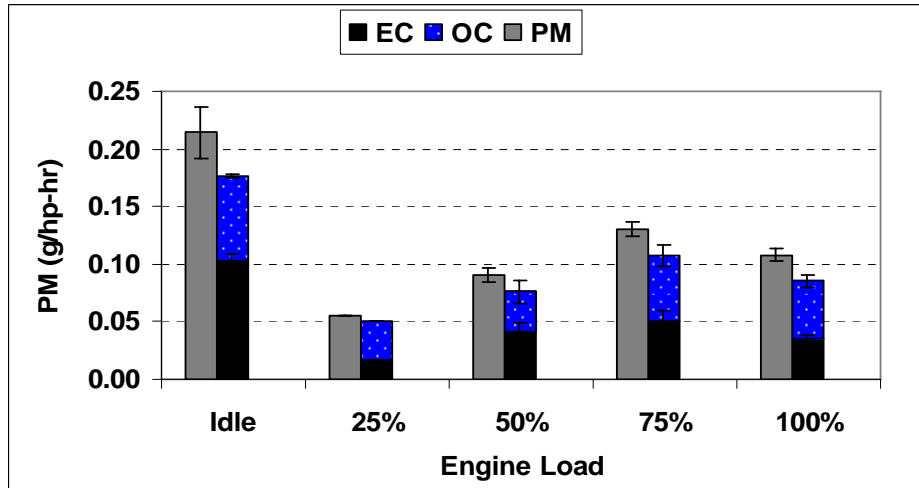

Figure 3-15 PM_{2.5} Mass Balance for B0

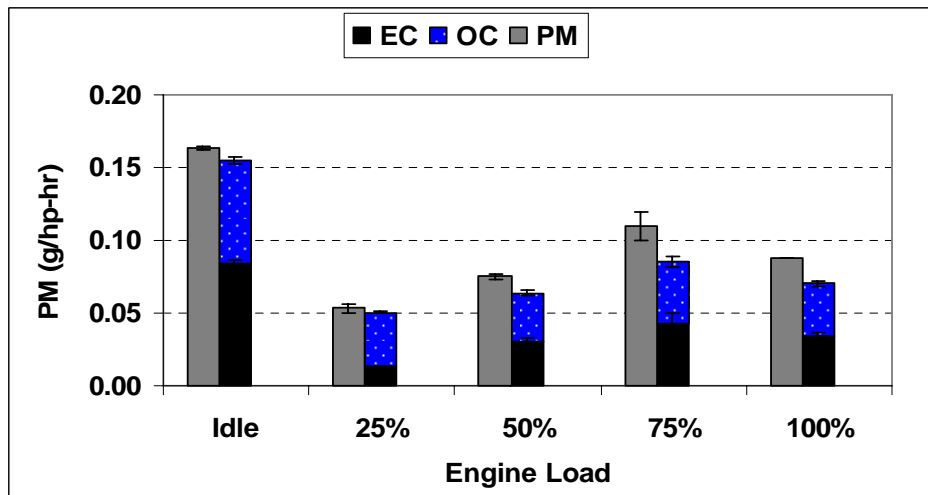

Figure 3-16 PM_{2.5} Mass Balance for B20

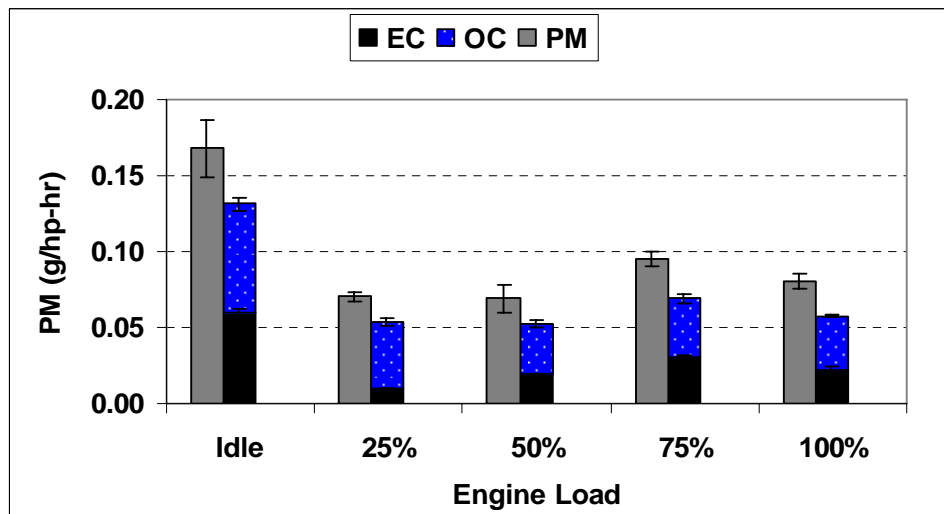

Figure 3-17 PM_{2.5} Mass Balance for B50

3.3.5. Real Time PM_{2.5} Monitoring

There is currently no reference method for measuring real-time PM_{2.5} emissions. UCR has used TSI's DustTrak for monitoring real-time PM_{2.5} emissions from several different diesel sources and compared the results obtained from the DustTrak to the reference filter method. The DustTrak provides a reasonably good correlation with the PM_{2.5} emissions on the filter. For this project, real-time emissions were measured for each of the steady state engine modes as well as an actual cruise on the bay. The cruise on the bay, a 45 minute trip, was too long for the reference filter method. A correlation between the PM_{2.5} readings from the reference method and DustTrak was developed for each of the fuels. As expected Figures 3-18, 3-19 and 3-20 show reasonably good correlations between the reference method and DustTrak for the PM_{2.5} concentrations measured in the dilution tunnel.

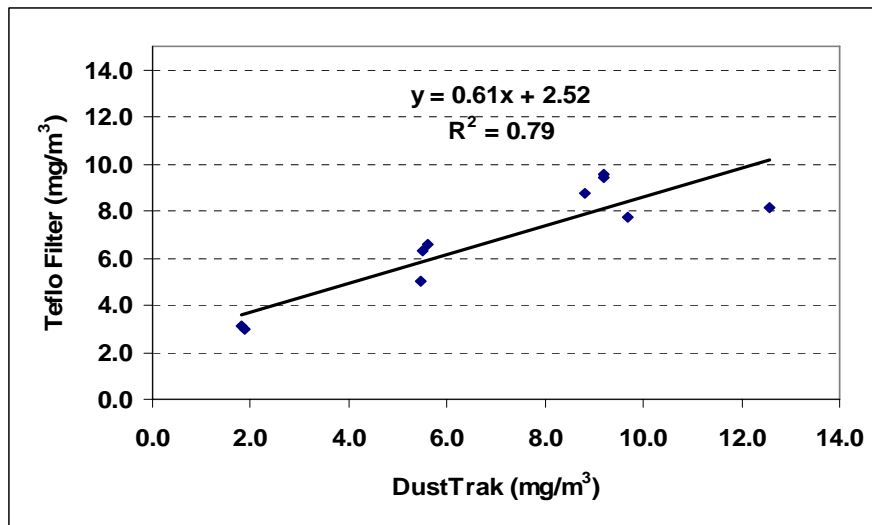

Figure 3-18 Correlation between PM_{2.5} Reference to DustTrak in Dilute Exhaust for B0

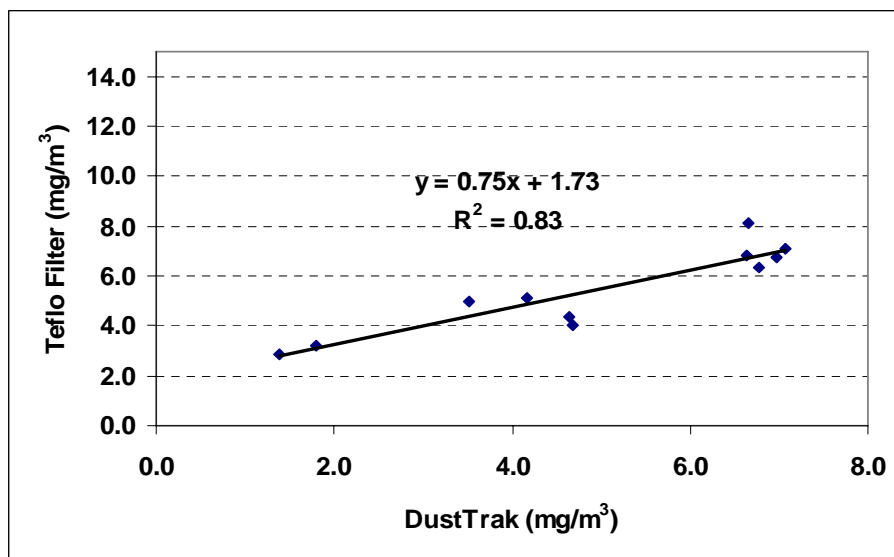

Figure 3-19 Correlation between PM_{2.5} Reference to DustTrak in Dilute Exhaust for B20

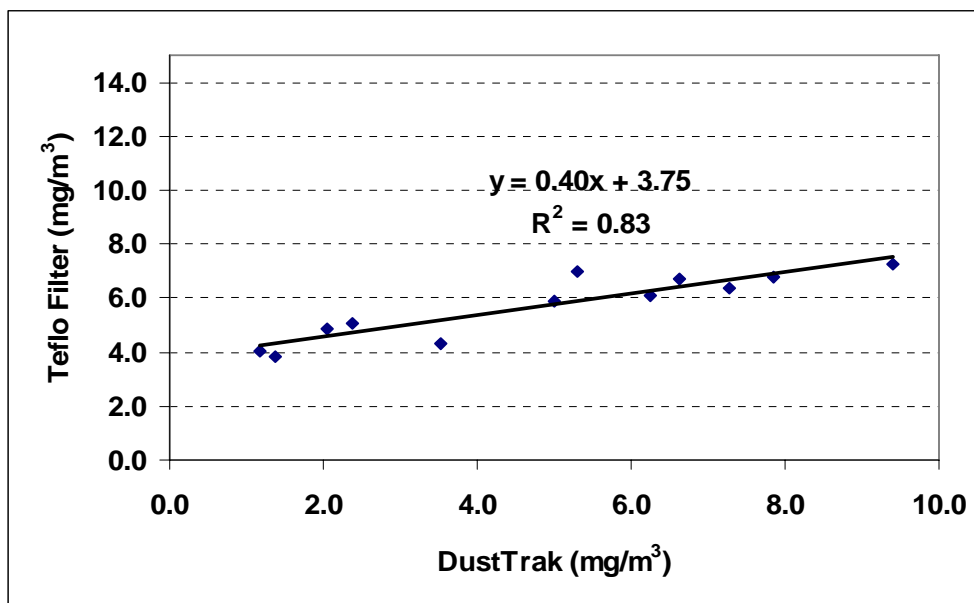

Figure 3-20 Correlation between PM_{2.5} Reference to DustTrak in Dilute Exhaust for B50

3.4. In-Use Test Cycle

To determine the actual in-use emissions of the boat real-time gaseous and PM_{2.5} emissions were measured for a typical cruise (Figure 3-21) in the bay. B20, the fuel normally used in the boat, was the chosen fuel for the in-use cycle.



Figure 3-21 Approximate Trace of a Typical Cruise in the Bay

As mentioned in Section 3.3 PM_{2.5} emissions were monitored using a DustTrak. Using the correlation in Figure 3-19 and the average value of dilution ratio across all steady state modes the real-time PM_{2.5} emissions was calculated. A real-time trace of the gaseous and PM_{2.5} emissions in g/hr is shown in Figure 3-22.

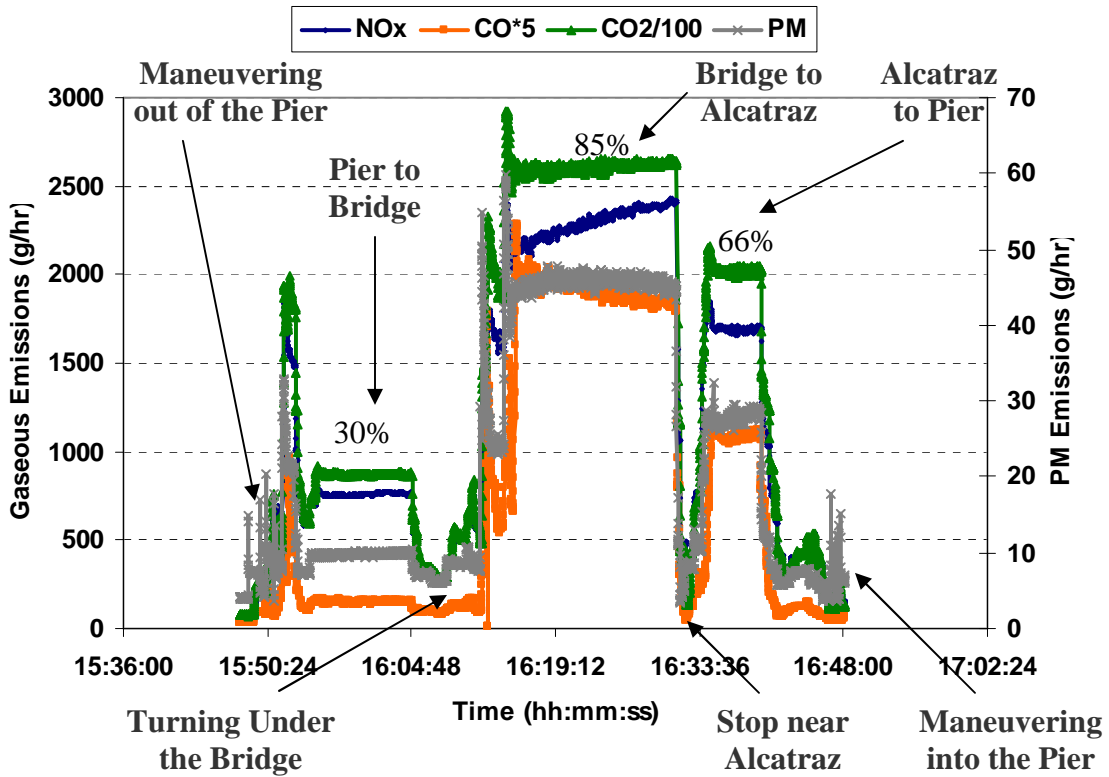

Figure 3-22 Real-Time Emissions Trace for Typical Cruise in the Bay

4. Discussions

The goals of this project were

- To compare the actual in-use emissions of gases (CO₂, CO, NO_x) and particulate matter (PM_{2.5}) mass from a modern Tier 2 marine engine while operating on ultra low sulfur CARB diesel with the certification values.
- To measure the effect of biodiesel blends on the in-use emissions from a modern Tier 2 marine diesel engine.

For this purpose one of the two propulsion engines on-board a ferry/excursion boat was tested on three fuels B0, B20 and B50. Emissions testing was performed based on the ISO 8178-1 protocol following the load points in the ISO 8178 E3 test cycle. A discussion of the results from this testing is presented in this section.

4.1. Comparison with Tier 2 Standards and Manufacturer's Certification for that Engine Family

The first step in the analysis was to determine if the test engine met the Tier 2 standards as well as the certification obtained from the engine manufacturer for the engine family. Table 4-1 and Figure 4-1 show a comparison of the measured weighted emission factors, the Tier 2 and Tier 3 standards and the manufacturer's certification values for the engine family.

Table 4-1 Comparison of Weighted Emission Factors in g/hp-hr

Criteria Pollutant	Measured Emissions B0	Measured Emission B20	Measured Emissions B50	Standards		Manufacturer's Certification for Engine Family [†]
				Tier 2	Tier 3	
CO ₂	588 ± 5	597 ± 3	591 ± 10	n/a	n/a	n/a
CO	1.84 ± 0.04	1.85 ± 0.04	1.72 ± 0.05	3.7	3.7	0.99
NO _x	5.33 ± 0.04	5.3 ± 0.2	5.6 ± 0.2	5.4*	4.3*	4.99
THC	n/a	n/a	n/a			0.14
PM _{2.5}	0.116 ± 0.004	0.097 ± 0.004	0.087 ± 0.002	0.15	0.09	0.05

*n/a: not applicable, *Standard is for NO_x + THC, [†]See Appendix C*

The total hydrocarbon (THC) emissions were not measured as a part of this program as they were expected to be very low as seen from the manufacturer's certification value. Comparing the measured NO_x emission factor 5.33 ± 0.04 g/hp-hr (for B0) and the manufacturer's certification value for THC of 0.14 g/hp-hr with the Tier 2 emissions standard for NO_x + THC 5.4 g/hp-hr, we can say with reasonable confidence that the engine will meet the Tier 2 emission standard for NO_x + THC. The measured NO_x emission factor was a higher than the manufacturer's certification 4.99 ghp-hr.

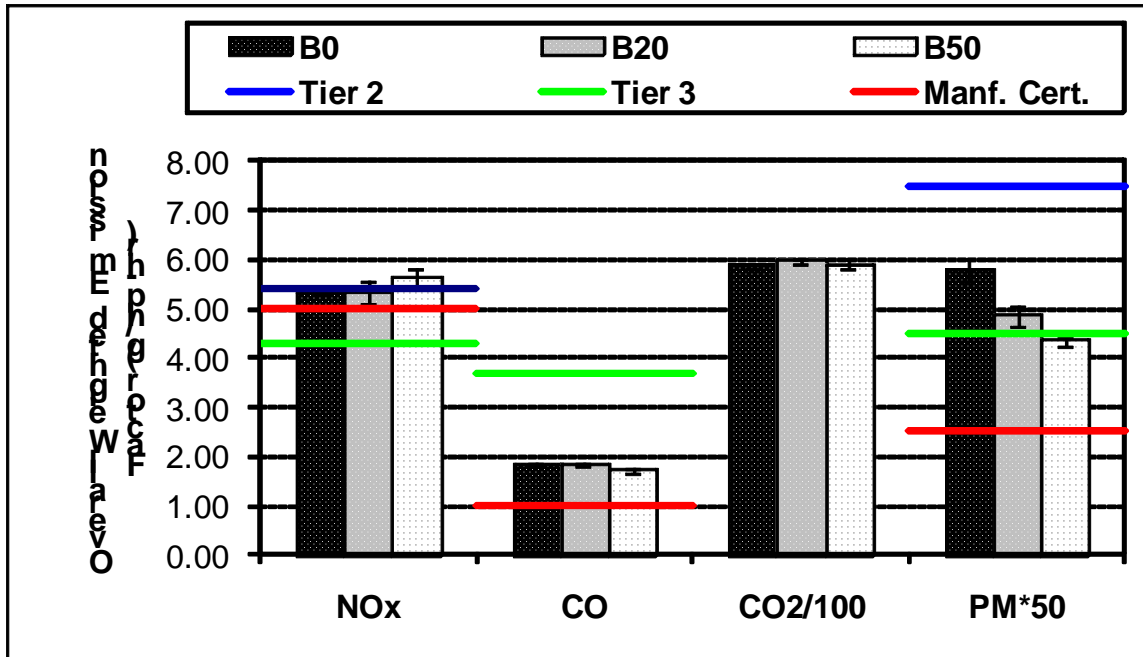

Note: Tier 2 and Tier 3 Standards on the NO_x bars represent NO_x + THC standard

Manf. Cert.: Manufacturer's Certification for the Engine Family

Figure 4-1 Overall Weighted Average Emission Factors for Gases and Total PM_{2.5}

The measured CO emission factor 1.84 ± 0.04 (for B0) was almost twice the engine manufacturer's certification value of 0.99 g/hp-hr but significantly lower than the Tier 2 and Tier 3 standard of 3.7 g/hp-hr.

The PM_{2.5} emission factor 0.116 ± 0.004 g/hp-hr was against twice that of the manufacturer's certification value of 0.05 g/hp-hr but well within the Tier 2 standard of 0.15 g/hp-hr.

Overall this engine does meet the Tier 2 emission standards while operating on B0 and is representative of a modern marine diesel engine. The use of B50 resulted in a slight increase in the NO_x emission factor and a significant decrease in the PM_{2.5} emission factor. As a result, the engine operating on B50 fuel does not meet the Tier 2 standard for NO_x + THC. It does, however meet the Tier 3 standard for PM_{2.5}.

4.2. Steady State Test Modes

Gaseous Emissions

CO₂ emissions factors were found to range from 557 to 601 g/hp-hr which is typical of four stroke diesel engines. As expected there was no significant variation in the CO₂ emission factors across the different fuel types.

NO_x emission factors varied from 5.2 to 5.7 g/hp-hr across all load points and fuel types. No significant change was observed in the NO_x emission factor across fuels or engine modes.

CO emission factors were <1.0 g/hp-hr for all loads except the 75% load point where it was ~2.7 g/hp-hr. There was an average decrease of 16% by switching to B20 at the 25% and 50% engine load points. No significant change was observed at the other loads. As a result the overall weighted average emission factor for CO did not change from B0 to B20. For B50, an reduction of 15% to 34% was observed at all but the 75% engine load where no significant change was seen. This translates to a 7% decrease in the overall weighted average CO emission factor when switching from B0 to B50 fuel.

Total PM_{2.5} Mass Emissions

The total PM_{2.5} mass emission factors ranged from 0.053 to 0.131 g/hp-hr for all fuels at the ISO load points. As expected at the Idle mode the emission factor was higher 0.164 to 0.214 g/hp-hr. As mentioned earlier the engine meets the Tier 2 PM_{2.5} emission standard with B0 and B20 and the Tier 3 standard with B50.

Switching from B0 to B20 resulted in a reduction of 16% to 24% in the PM_{2.5} emission factors at all but the 25% engine load point where no significant change was observed. The overall weighted average PM_{2.5} emission factor shows a reduction of 16%.

A 28% to 33% reduction was observed in the PM_{2.5} emission factors when switching to B50 fuel at all except the 25% engine load point. At this load point a 28% increase in the PM_{2.5} emission factor was noted. This was due to a significant increase in the organic carbon fraction of the PM_{2.5}. The overall weighted average emission factors show a 25% reduction in total PM_{2.5} mass when switching from B0 to B50 fuel.

Speciated PM_{2.5} Mass Emissions

PM_{2.5} emissions from diesel exhaust are typically speciated into elemental and organic carbon (EC/OC). The EC emission factors ranged from 0.010 to 0.044 g/hp-hr across the ISO load points for all three fuels; the OC emission factors ranged from 0.035 to 0.058 g/hp-hr. As in the case of the gases the emission factors at Idle were higher than other loads points: 0.060 to 0.103 g/hp-hr for EC and ~0.072 g/hp-hr for OC.

When using B20, ~23% reduction in EC was seen at 50%, 25% and Idle modes and no significant change was observed at the higher loads. For OC, an 8% increase at the 25% load point; no significant change at the Idle and 50% load points and ~28% reduction at the 75% and 100% loads was observed.

The use of B50 resulted in a 53% to 38% reduction of EC across all engine load points. The change in OC with B50 was similar to that of B20, 28% increase at the 25% engine load, no significant change at the Idle and 50% modes and a 27% to 33% reduction at the 75% and 100% loads. This large increase in OC at the 25% load point is the reason for the total PM_{2.5} mass increase at that mode.

A look at the overall weighted average emission factors shows the following

- B20: 14% reduction in EC; 23% reduction in OC
- B50: 42% reduction in EC; 27% reduction in OC

The speciation of total PM_{2.5} mass emission for B0 and B20 were similar; the EC accounting for ~42% of the total mass and OC ~41% across all loads except the 25% engine load. At this load EC was 25-29% of the total PM_{2.5} mass and OC was 62-70%. The PM_{2.5} from B50 had a different speciation with ~31% EC and ~44% of OC at all but the 25% load point. At this load point as in the case of the other two fuels the % of EC in PM mass was lower at 14% and that of OC was higher at 63%. Overall the ratio of OC to EC was significantly higher for B50 when compared to B20 and B0.

4.3. Actual In-Use Emissions Cycle

Real time gaseous and PM_{2.5} emissions were measured during a typical cruise in the bay. The boat sailed from the pier to the Golden Gate Bridge to Alcatraz and back to the pier. The direction of the ocean currents in the bay was outward from the pier to the Golden Gate Bridge.

It is interesting to note that the currents resulted in significant differences in the engine loads during the cruise. Though the boat was sailing at a constant speed it was noted that the engine operated at a 30% load while the boat sailed from the pier to the bridge, 85% from the bridge to Alcatraz and 66% from Alcatraz back to the pier. Comparing emissions during the journey from the pier to the Golden Gate Bridge to that from the bridge we see the following

- A threefold increase in NO_x and CO₂
- A thirteen fold increase in CO
- A fivefold increase in the total PM_{2.5} mass emissions

This shows that ocean currents can have significant effect on the emissions from the boat.

During the journey from the bridge to Alcatraz a definite increase in NO_x and a decrease in CO were seen with time though CO₂ emissions remained quite steady. Spikes in the PM_{2.5} emission factors were observed when the boat maneuvered out of and into the pier.

5. Summary and Recommendations

The primary goal of this project was to measure the emissions benefits of a U.S. EPA Tier 2 marine diesel engine from switching to biodiesel from ultra low sulfur diesel. For this purpose a 500hp, 1800rpm 4-stroke propulsion engine on board a ferry was tested on three fuels B0, B20 and B50. The testing was conducted based on the ISO 8178-1 protocols following the load points in the ISO 8178 E3 cycle. Besides this test cycle, an additional Idle mode was included since the ferry spends a significant amount of time idling at the dock. Real time in-use emissions were also measured for a typical cruise in the San Francisco bay.

Overall the test program was successful. Several quality control checks such as fuel to exhaust carbon balance, total PM_{2.5} to speciated PM_{2.5} mass balance, <2% standard deviation in CO₂ emission factors at each of the steady state load points and reasonable error bars on the final reading showing good repeatability and reproducibility helped validate the of the test. Besides this a comparison of the measured values with the certification values and the Tier 2 standards showed that the in-use engine was operating within specification.

Detailed emission factors of gaseous emission including CO₂, CO, NO_x, total and speciated PM_{2.5} mass emissions for three fuels B0, B20 and B50 are presented in this report. The major findings of this program include:

- No significant change in CO₂ and NO_x emission factors across all loads
- 7% decrease with B50 and no significant change with B20 was observed in the overall weighted average CO emissions factor.
- A 25% reduction in overall weighted average total PM_{2.5} mass emission factor was observed with B50; B20 showed 16% reduction. The modal data showed a distinctly different behavior at the 25% load point where a 28% increase with B50 and no significant change with B20 was observed in the PM_{2.5} emission factors. All other modes showed a reduction in PM_{2.5} for both fuels.
- The reduction in total PM_{2.5} mass can be attributed to the decrease in overall weighted emission factors for EC (B20 14%, B50 42%) and OC (B20 23%, B50 27%) fractions of the PM_{2.5} mass. Again the 25% load point was distinctly different showing an increase in OC: 8% for B20 and 28% for B50. This increase in OC is the primary cause for the increase in PM_{2.5} mass at this mode.
- The nature of the PM_{2.5} mass was significantly different for B50 compared to B20 and B0 as B50 showed a higher OC/EC ratio across all engine loads.
- Ocean currents produce a significant effect on the engine load, resulting in as high as a threefold increase in NO_x and CO₂, thirteen fold increase in CO and a fivefold increase in the total PM_{2.5} mass emissions.

Identified below are some areas for further investigation

- Testing the B100 fuel could have given further insight into the maximum amount of $PM_{2.5}$ emissions savings that is achievable by switching to biodiesel.
- Since the speciation of the $PM_{2.5}$ mass emissions changed with the use of B50, it would be interesting to measure the particle size distribution to see if there are any differences in the particle number or size across the fuels.
- B50 showed a more organic $PM_{2.5}$ mass emissions, this could indicate a shift in the nature of the gaseous hydrocarbons as well. Measurement of the toxic hydrocarbons like carbonyls, alkanes and poly aromatic hydrocarbons could reveal different patterns for biodiesel as compared to diesel.
- Development of a real-time duty cycle will help to quantify the actual effect of these engines on the inventory, since they operate very differently from the ISO certification cycle spending considerable time idling.

6. References

California Department of Finance, 2000a. Department of Finance 2000–2001 *Governor's Budget. State of California*, Sacramento, CA, p. 131.

California Department of Finance, 2000b. *State of California 2000–2001 Final Budget Summary*. State of California, Sacramento, CA, p. 893.

Cooper, C., *Heavy Duty Non-road Engine Activity and Emissions in the Northeast*. Draft Final Report. Northeast States for Coordinated Air Use Management Boston, MA, 2001a.

Cooper, C., *Marine Vessel Emissions Inventory*. Northeast States for Coordinated Air Use Management, Boston, MA, 2001b.

Farrell, A.; Corbett, J., In *TR-News*, pp. 19–28. 2000

Federal Highway Administration (FHWA), 1999. Federal Register, vol. 64, No. 54: Notice of Request for Clearance of a New Information Collection: National Ferry Study. FRDoc. 99-6848, Federal Highway Administration, Department of Transportation, Washington, DC, p. 13843.

Graboski, M.S and McCormick, R.L. (1998) Combustion of Fat and Vegetable Oil Derived Fuels in Diesel Engines

Götze, H.-J., Krapp, R., Neddenien, S., Ulrich, E., 1999. *Diesel Engine Exhaust Gas Emissions—Research, Assessment and Certification*. Proceedings from MARPOWER 1999, Newcastle, UK.;

ISO 8178, 'Reciprocating Internal Combustion Engines – Exhaust Emission Measurement', Parts 1 to 9.

Klokk, S.N., 1997. Measures for Reducing NO_x Emissions from Ships. Workshop on Control Technology for Emissions from Off-Road Vehicles and Machines, Ships and Aircraft, Oslo, Norway, 8–9 June, 1997.

Lloyd's Register Engineering Services, *Marine Exhaust Emissions Research Programme*, London, England, 1995.

Perata, D., 1999. Regulation in Government Code. vol. Section 66540.

7. Glossary of Symbols and Abbreviations

B0	ultra low sulfur diesel
B20	blend of 20% biodiesel and 80% ultra low sulfur diesel
B50	blend of 50% biodiesel and 50% ultra low sulfur diesel
°C	degree centigrade
CA	California
CARB	California Air Resources Board
CE-CERT	College of Engineering – Centre of Environmental Research and Technology
CFO	Critical Flow Orifice
CFR	Code of Federal Regulation
cm ²	square centimeter
CO	Carbon monoxide
CO ₂	Carbon dioxide
DAF	Dilution Air Filter
DNPB	2,4Dinitrophenylhydrazine
DT	Dilution Tunnel
EC	Elemental Carbon
EGA	Exhaust Gas Analyzer
EP	Exhaust Pipe
EPA	Environmental Protection Agency
°F	degree Farenheit
F.S./day	full scale per day
gph	gallons per hour
g/hp-hr	grams per horsepower-hour
g/hr	grams per hour
HCLD	heated chemiluminescence detector
HEPA	High Efficiency Particulate Air
hh:mm:ss	hour : minute : second
in Hg	inches of mercury
ISO	International Organization for Standardization
K	degree Kelvin
kg/hr	kilograms per hour
kg/m ³	kilograms per cubic-meter
kPa	kilo Pascal
lit/min	liter per minute
lit	liters
mg/filter	milligram per filter
mg/m ³	milligram per cubic meter
mm	millimeter
mm/dd/yy	month/date/year
MI	Michigan
min	minutes
NDIR	Non-dispersive infra red

NIOSH	National Institute of Occupations Safety and Health
NO _x	Oxides of Nitrogen
OC	Organic Carbon
PM _{2.5}	Particulate Matter
PTFE	Polytetrafluoroethylene or Teflon Filter
ppm	parts per million
ppmV	parts per million by volume
PUF/XAD	Poly Urethane Foam/XAD
QC/QA	Quality Control/Quality Assurance
RH	Relative Humidity
RPM	revolutions per minute
scfm	standard cubic feet per minute
SP	Sampling Probe
T	Temperature
TDS	Thermal Desorption System
TT	Transfer Tube
ug/filter	microgram per filter
UCR	University of California, Riverside
U.S.	United States
VN	Venturi
vol%	volume %
WI	Wisconsin

8. Appendix A

8.1. Certification Emission Test Protocol for Marine Propulsion Engines

In general, the operating conditions during a certification test for internal combustion engines follows a prescribed sequence that is specified in the ISO 8178-Part 4, *Test cycles for different engine applications*. The ISO 8178 E-3 test cycle is used for heavy duty marine engines used for propulsion. The standard test protocol consists of a series of preconditioning cycles to warm and stabilize the engine at full load followed by a sequence of stabilization and testing at the five specified modes, each with a defined speed, load and minimum test duration as shown in The weighting factors used in the determination of the emission factor are listed as well.

Table 8-1 Five Mode Test Cycle for Heavy-Duty Marine Engines (ISO-8178-E-3 test cycle)

Mode number	Engine Speed %	Observed Torque %	Weighting factors
1	100	100	0.2
2	91	75	0.5
3	80	50	0.15
4	63	25	0.15

During this time the gases and particulate matter in the exhaust are sampled and analyzed according to the previously described procedures. Additionally, the engine conditions, such as charge air pressure and temperature, and the engine operating parameters used to determine the mass flow rate were measured and recorded at each test mode. The test procedure was designed to determine the brake-specific emissions of criteria emissions: carbon monoxide, oxides of nitrogen, and particulate matter.

8.2. Protocol for Measuring Actual In-Use Emissions from Marine Propulsion Engines

UCR has considerable experience in making real time measurements of emissions from various pieces of operating equipment. Methods for sampling and analysis of the gases and particulate matter (PM) from actual in-use marine engines were selected in conformance to the requirements of ISO 8178-1¹.

¹ *International Standards Organization, ISO 8178-1, Reciprocating internal combustion engines - Exhaust emission measurement -Part 1: Test-bed measurement of gaseous particulate exhaust emissions, First edition 1996-08-15*

The approach involved the use of a partial flow dilution system with single venturi as shown in Figure 8-1. Raw exhaust gas was transferred from the exhaust pipe (EP) to the dilution tunnel (DT) through the sampling probe (SP) and the transfer tube (TT) due to the negative pressure created by the venturi (VN) in DT. The transfer line is heated to prevent condensation of exhaust components (including water and sulfuric acid) at any point in the sampling and analytical systems.

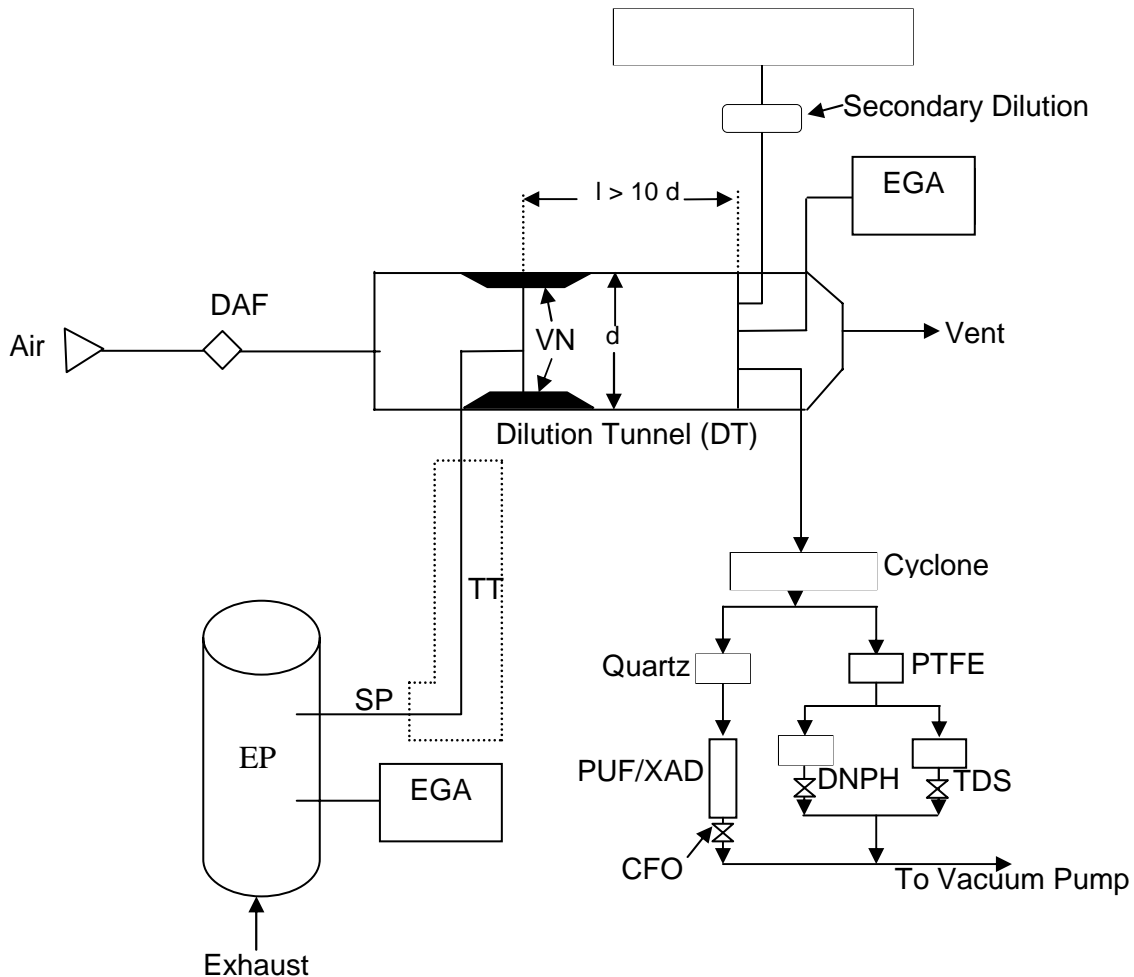

Figure 8-1 Partial Flow Dilution System with Single Venturi, Concentration Measurement and Fractional Sampling

The gas flow rate through TT depends on the momentum exchange at the venturi zone and is therefore affected by the absolute temperature of the gas at the exit of TT. Consequently, the exhaust split for a given tunnel flow rate is not constant, and the dilution ratio at low load is slightly lower than at high load. The tracer gas concentrations (CO_2 or NO_x) are measured in the raw exhaust gas, the diluted exhaust gas and the dilution air using the exhaust gas analyzer (EGA), and the dilution ratio is calculated from the measured values.

In order to apply the ISO approach in the field, UCR designed a portable set of equipment that is field deployable. The equipment fits into several metal cases with an interior of foam molding to allow sensitive equipment, like computers, to be easily transported or even be lifted and dropped into cargo areas on a vessel without harm to the contents. For practical purposes, the design includes pieces of equipment that allow the use of a range of common electrical (120/240V, 50/60Hz) and supply air utilities. For example, while UCR tries to obtain instrument grade pressurized air for dilution air, we further process any supply air through a field processing unit to assure the quality of the dilution air. The processing air takes the supply air through a number of steps including reducing the pressure to about 30psig as that allows a dilution ratio of about 5/1 in the geometry of our system. The next stages, in sequence, for conditioning the supply air included: liquid knock-out vessel, desiccant to remove moisture with silica gel containing an indicator, hydrocarbon removal with activated charcoal and a HEPA filter for the fine aerosols that might be present in the supply air. The silica gel and activated carbon are changed for each field campaign. Figure 6-2 below shows the unit for processing the dilution air.



Figure 8-2 Field Processing Unit for Purifying Dilution Air in Carrying Case

8.2.1. Measuring Criteria Gaseous Emissions

The concentrations of gases in the raw exhaust and the dilution tunnel were measured with a Horiba PG-250 portable multi-gas analyzer. The PG-250 can simultaneously measure up to five separate gas components using the measurement methods recommended by the EPA. The signal output of the instrument was interfaced directly with a laptop computer through an RS-232C interface to record measured values continuously. Major features include a built-in sample conditioning system with sample pump, filters, and a thermoelectric cooler. The performance of the PG-250 was tested and verified under the U.S. EPA ETV program.



Figure 8-3 In-Field Illustration of Continuous Gas Analyzer and Computer for Data Logging

Details of the gases and the ranges for the Horiba instrument are shown in Table 8-2. Note that the Horiba instrument measured sulfur oxides (SO_2); however, the ISO reference¹ reports: “The SO_2 concentration shall be calculated from the sulfur content of the fuel used, since experience has shown that using the direct measurement method for SO_2 does not give more precise results.”

For quality control, UCR carried out analyzer checks with calibration gases both before and after each test to check for drift. Because the instrument measures the concentration of five gases, the calibration gases are a blend of several gases (super-blend) made to within 1% specifications by Praxair (Los Angeles, CA). Drift was determined to be within manufacturer specifications of $\pm 1\%$ full scale per day, except for SO_2 set at $\pm 2\%$ F.S./day. Other specifications of the instruments are provided in Table 8-3.

Table 8-2 Detector Method and Concentration Ranges for Monitor

Component	Detector	Ranges
Nitrogen Oxides (NO _x)	Heated Chemiluminescence Detector (HCLD)	0-25, 50, 100, 250, 500, 1000, & 2500 ppmv
Carbon Monoxide (CO)	Non dispersive Infrared Absorption (NDIR)	0-200, 500, 1000, 2000, & 5000 ppmv
Carbon Dioxide (CO ₂)	Non dispersive Infrared Absorption (NDIR)	0-5, 10, & 20 vol%
Sulfur Dioxide (SO ₂)	Non dispersive Infrared Absorption (NDIR)	0-200, 500, 1000, & 3000 ppmv
Oxygen	Zirconium oxide sensor	0-5, 10, & 25 vol%

Table 8-3 Quality Specifications for the Horiba PG-250

Repeatability	±0.5% F.S. (NO _x : ≤100ppm range CO: ≤1000ppm range) ±1.0% F.S.
Linearity	±2.0% F.S.
Drift	±1.0% F.S./day(SO ₂ : ±2.0%F.S./day)

8.2.2. Measuring the Particulate Matter (PM) Emissions

A raw particulate sampling probe was fitted close to and upstream of the raw gaseous sample probe in the exhaust. In order to measure PM, a sampling probe was inserted into the end of the dilution tunnel (>10 diameters downstream) and directed to a PM sample splitter that allowed up to three samples to be collected.

For this test, we used one of the PM lines and directed it to a cyclone separator, sized to remove particles >2.5µm. From the separator, we added two lines with 47 Gelman filter holders, one for collecting PM on a Teflo™ filter and the other for collecting PM on a Quartz filter. Thus the flow in the dilution tunnel was split into two fractions, a smaller flow for measuring PM mass and PM properties and a much larger flow that was vented

outside the vessel. Note, with the partial dilution approach for measuring gases and PM, it is critical for the dilution ratio be determined very accurately.

UCR collected simultaneous Teflo™ and Quartz filters at each operating mode and analyzed them according to standard procedures. The simultaneous collection of Quartz and Teflo™ filters allows an internal quality check of the PM mass. Teflo™ filters used to acquire PM mass were weighted following the procedure of the Code of Federal Regulations (CFR) (40 CFR Part 86). Briefly, total PM were collected on Pall Gelman (Ann Arbor, MI) 47 mm Teflo™ filters and weighed using a Cahn (Madison, WI) C-35 microbalance. Before and after collection, the filters were conditioned for 24 hours in an environmentally controlled room (RH = 40%, $T = 25\text{ }^{\circ}\text{C}$) and weighed daily until two consecutive weight measurements were within 3 μg .

The PM mass on the Teflo™ filter was then extracted in double distilled water after wetting the filter surface with a few drops of isopropyl alcohol. This solution was then filtered and analyzed in a Dionex ICS 1000 using Ion Chromatography to determine the mass of sulfate on the filter.

PM samples were collected in parallel on a 2500 QAT-UP Tissuquartz Pall (Ann Arbor, MI) 47 mm filters that were preconditioned at 600°C for 5 h. A 1.5 cm² punch is cut out from the Quartz filter and analyzed with a Sunset Laboratory (Forest Grove, OR) Thermal/Optical Carbon Aerosol Analyzer according to the NIOSH 5040 reference method (NIOSH 1996). All PM filters were sealed in containers immediately after sampling, and kept chilled until analyzed.

8.3. Quality Control/Quality Assurance (QC/QA)

Each of the laboratory methods for PM mass and chemical analysis has a standard operating procedure including the frequency of running the standards and the repeatability that is expected when the standard is run. Additionally the data for the standards are plotted to ensure that the values fall within the upper and lower control limits for the method and that there is no obvious trends or bias in the results for the reference materials. As an additional quality check, results from independent methods are compared and values from this work are compared with previously published values, like the manufacturer data base.

- For the ISO cycles, run the engine at rated speed and the highest power possible to warm the engine and stabilize emissions for about 30 minutes.
- Determine a plot or map of the peak power at each engine RPM, starting with rated speed. UCR suspected the 100% load point at rated speed was unattainable with propeller torque so Mode 1 would represent the highest attainable RPM/load.
- Emissions were measured while the engine operates according to the requirements of ISO-8178-E3. For the marine propulsion engine the highest power mode was run first and the then each mode was run in sequence The minimum time for marine propulsion engine samples was 5 minutes and if necessary, the time was

extended to collect sufficient particulate sample mass or to achieve stabilization with large engines.

- The gaseous exhaust emission concentration values were measured and recorded for the last 3 min of the mode.
- Engine speed, displacement, boost pressure, and intake manifold temperature were measured in order to calculate the gaseous flow rate.
- Emissions factors are calculated in terms of grams per kilowatt hour for each of the operating modes and fuels tested, allowing for emissions comparisons of each blend relative to the baseline fuel.

9. Appendix B

PASEO CARGILL ENERGY LLC.



BIODIESEL

(Soy Fatty Acid Methyl Ester)

Certificate of Analysis

Lot Number KCBD08121819
 Car/Truck TILX 281092
 Load Order 102258
 Load Date Saturday, December 20, 2008

PROPERTY	METHOD	SPECIFICATION	RESULT
Visual Appearance	ASTM D 4178	2.0 max.	1.0
Acid Number	ASTM D 654	0.50 max. mg KOH/g	0.13 mg KOH/g
Cloud Point	ASTM D 2500	Report °C	-1 °C
Flash Point	ASTM D 93	130 min. °C	188 °C
Water & Sediment	ASTM D 2709	0.050 max. % vol	0.000 % vol
Free Glycerin	ASTM D 6584	0.020 max. %	0.002 %
Total Glycerin	ASTM D 6584	0.240 max. %	0.130 %
Monoglycerides	ASTM D 6584	Report %	0.414 %
Diglycerides	ASTM D 6584	Report %	0.095 %
Triglycerides	ASTM D 6584	Report %	0.070 %
Sulfated Ash *	ASTM D 674	0.020 max. mass%	0.005 mass %
Carbon Residue *	ASTM D 4530	0.050 max. mass%	<0.050 mass %
Cetane *	ASTM D 613	47 min.	50
Copper Strip Corrosion *	ASTM D 130	3 max.	1
Phos Content *	ASTM D 4951	10 max. ppm	<1.0 ppm
Sulfur Content	ASTM D 4961	0.00-15.00 ppm	1.30 PPM
Kinematic Viscosity *	ASTM D 445	1.90-6.00 mm ² /sec	4.08 mm ² /sec
Molature (Karl Fisher)	Volumetric	Report %	0.014 %
Cold Soak Filtration	Annex A1	200 sec. max	54 SEC
Oxidative Stability	EN 14112	3 hrs min	7.7 HR
Group I Metals *	EN 14538	5 ppm Max	<1.8 PPM
Group II Metals *	EN 14538	5 ppm Max	<1.8 PPM
Vacuum Distillation *	ASTM D 1180	360° C Max @ 90%	352.0 DEGC

* These results are based on typical analysis.

** 0.1% #2 diesel fuel has been blended with this load.

Approval:

Date:

Monday, January 05, 2009

PASEO CARGILL ENERGY LLC

1920 E FRONT ST

KANSAS CITY, MO 64120

ph: 816-245-0514

fax: 816-245-0509

March 16, 2009

DATA SUMMARY FOR UNIVERSITY OF CALIFORNIA AT RIVERSIDE
SWRI WORKORDER #46863
PO RT10214387

	Description	Sample	B-0	B-20	B-50
TEST		UNITS			
D1319	Aromatics	%	21.2	-	-
	Olefins	%	3.4	-	-
	Saturates	%	75.4	-	-
D4052s	API@60F		37.2	35.3	33.1
	SPGr@60E		0.8389	0.8486	0.8595
	Density @15C	grams/L	838.4	848.1	859
D5185s	Sulfur by ICP	ppm	<25*	-	<25*
EN14078	FAME	Volume %	-	22.6	46.4

* The limit of detection for D5185s is 25 parts per million.

No uncertainties have been determined for these results, but ASTM repeatability may be referenced.

The information contained in this document is legally privileged and/or proprietary business information intended only for the use of the individual or the entity named above. If the reader of this document is not the intended recipient, you are hereby notified that any dissemination, distribution, or copy of this document is strictly prohibited. If you have received this document in error, please immediately notify us by telephone at 210/522-3844 and return the original document to the sender at the return address via the United States Postal Service.

Institute shall not publish or make known to others the subject matter or results of the Project or any information obtained in connection therewith which is proprietary and confidential to Client without Client's written approval. No advertising or publicity containing any reference to Institute or any of its employees, either directly or by implication, shall be made use of by Client or on Client's behalf without Institute's written approval. In the event Client distributes any report issued by Institute on this Project outside its own organization, such report shall be used in its entirety, unless Institute approves a summary or abridgement for distribution.

OJPDACP9(RT10212387)

Page 2 of 2



HOUSTON, TEXAS (713) 977-1377 • WASHINGTON, DC (301) 881-0226

10. Appendix C

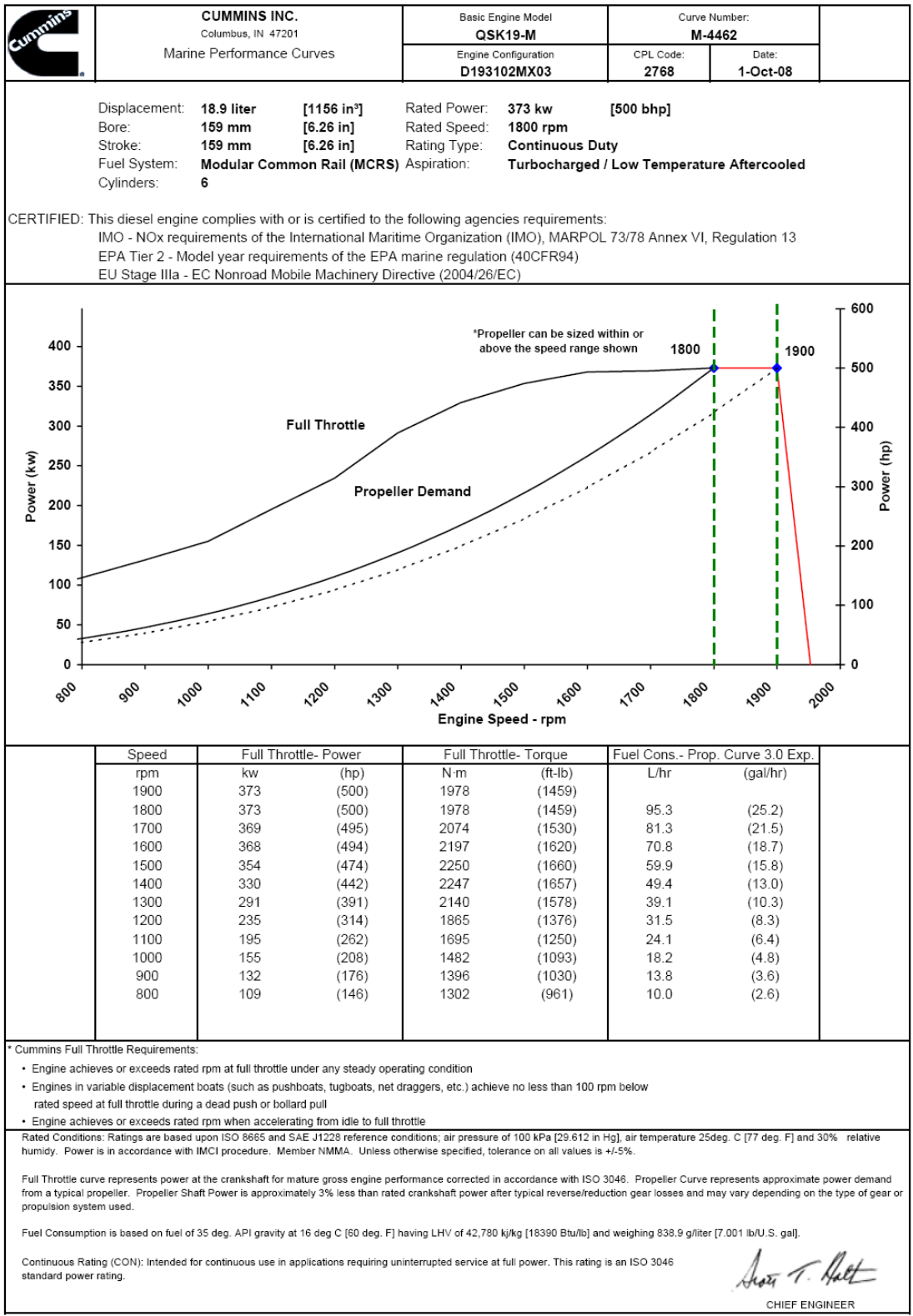

Propulsion Marine Engine Performance Data

Curve No. M-4462
 DS : D19-MX-1
 CPL : 2768
 DATE: 1-Oct-08

General Engine Data

Engine Model	QSK19-M
Rating Type	Continuous Duty
Rated Engine Power	373 [500] kW [hp]
Rated Engine Speed	1800 rpm
Rated Power Production Tolerance	±% 3
Rated Engine Torque	1978 [1459] N·m [lb·ft]
Peak Engine Torque @ 1500 rpm	2250 [1660] N·m [lb·ft]
Brake Mean Effective Pressure	1312 [190] kPa [psi]
Indicated Mean Effective Pressure	2629 [381] kPa [psi]
Maximum Allowable Engine Speed	2450 rpm
Maximum Torque Capacity from Front of Crank ²	2339 [1725] N·m [lb·ft]
Compression Ratio	15:1
Piston Speed	9.5 [1878] m/sec [ft/min]
Firing Order	1-5-3-6-2-4
Weight (Dry) - Engine Only - Average	2200 [4850] kg [lb]
Weight (Dry) - Engine With Heat Exchanger System - Average	2336 [5150] kg [lb]
Weight Tolerance (Dry) Engine Only	±3Std Dev(±%) 10.0

Governor Settings

Default Droop Value	Refer to MAB 2.04.00-03/23/2006 for Droop explanation	5%
Minimum Droop Allowed		0%
Maximum Droop Allowed		16%
High Speed Governor Break Point		1900 rpm
Minimum Idle Speed Setting		550 rpm
Normal Idle Speed Variation		±rpm 10
High Idle Speed Range Minimum		1900 rpm
High Idle Speed Range Maximum		1995 rpm

Noise and Vibration

Average Noise Level - Top	(Idle)	dBA @ 1m	82
	(Rated)	dBA @ 1m	92
Average Noise Level - Right Side	(Idle)	dBA @ 1m	85
	(Rated)	dBA @ 1m	96
Average Noise Level - Left Side	(Idle)	dBA @ 1m	85
	(Rated)	dBA @ 1m	97
Average Noise Level - Front	(Idle)	dBA @ 1m	87
	(Rated)	dBA @ 1m	99

Fuel System¹

Avg. Fuel Consumption - ISO 8178 E3 Standard Test Cycle	l/hr [gal/hr]	68.9 [18.2]
Fuel Consumption at Rated Speed	l/hr [gal/hr]	95.3 [25.2]
Approximate Fuel Flow to Pump	l/hr [gal/hr]	382.3 [101.0]
Maximum Allowable Fuel Supply to Pump Temperature	°C [°F]	60.0 [140]
Approximate Fuel Flow Return to Tank	l/hr [gal/hr]	287.0 [75.8]
Approximate Fuel Return to Tank Temperature	°C [°F]	50.4 [123]
Maximum Heat Rejection to Drain Fuel	kW [Btu/min]	1.5 [87]
Fuel Transfer Pump Pressure Range	kPa [psi]	N.A. [N.A.]
Fuel Pressure - Pump Out/Rail . Mechanical Gauge	kPa [psi]	N.A. [N.A.]
INSITE Reading	kPa [psi]	N.A. [N.A.]

TBD= To Be Determined

N/A = Not Applicable

N.A. = Not Available

- ¹ Unless otherwise specified, all data is at rated power conditions and can vary ± 5%.
- ² No rear loads can be applied when the FPTO is fully loaded. Max PTO torque is contingent on torsional analysis results for the specific drive system. Consult Installation Direction Booklet for Limitations.
- ³ Heat rejection to coolant values are based on 50% water/50% ethylene glycol mix and do NOT include fouling factors. If sourcing your own cooler, a service fouling factor should be applied according to the cooler manufacturer's recommendation.
- ⁴ Consult option notes for flow specifications of optional Cummins seawater pumps, if applicable.
- ⁵ May not be at rated load and speed. Maximum heat rejection may occur at other than rated conditions.

CUMMINS ENGINE COMPANY, INC
 COLUMBUS, INDIANA

All Data is Subject to Change Without Notice - Consult the following Cummins intranet site for most recent data:

<http://marine.cummins.com/>

Propulsion Marine Engine Performance Data

Curve No. M-4462
 DS : D19-MX-1
 CPL : 2768
 DATE: 1-Oct-08

Air System¹

Intake Manifold Pressure	kPa [in Hg]	144 [42]
Intake Air Flow	l/sec [cfm]	572 [1211]
Heat Rejection to Ambient	kW [Btu/min]	34 [1910]

Exhaust System¹

Exhaust Gas Flow	l/sec [cfm]	1294 [2,742]
Exhaust Gas Temperature (Turbine Out)	°C [°F]	404 [760]
Exhaust Gas Temperature (Manifold)	°C [°F]	523 [973]

Emissions (in accordance with ISO 8178 Cycle E3)

NOx (Oxides of Nitrogen)	g/kw-hr [g/hp-hr]	6.70 [4.99]
HC (Hydrocarbons)	g/kw-hr [g/hp-hr]	0.18 [0.14]
CO (Carbon Monoxide)	g/kw-hr [g/hp-hr]	1.32 [0.99]
PM (Particulate Matter)	g/kw-hr [g/hp-hr]	0.07 [0.05]

Cooling System¹

Sea Water Pump Specifications	MAB 0.08.17-07/16/2001	
Pressure Cap Rating (With Heat Exchanger Option)	kPa [psi]	103 [15]

Engines with Low Temperature Aftercooling (LTA)

Single Loop LTA

Coolant Flow to Cooler (with blocked open thermostat).....	l/min [gal/min]	238 [63]
LTA Thermostat Operating Range (Start to Open)	°C [°F]	66 [150]
LTA Thermostat Operating Range (Full Open)	°C [°F]	80 [175]
Heat Rejection to Engine Coolant ³	kW [Btu/min]	300 [17100]
Maximum Coolant Inlet Temperature from LTA Cooler.....	°C [°F]	49 [120]

TBD= To Be Determined

N/A = Not Applicable

N.A. = Not Available

- ¹ Unless otherwise specified, all data is at rated power conditions and can vary ± 5%.
- ² No rear loads can be applied when the FPTO is fully loaded. Max PTO torque is contingent on torsional analysis results for the specific drive system. Consult Installation Direction Booklet for Limitations.
- ³ Heat rejection to coolant values are based on 50% water/50% ethylene glycol mix and do NOT include fouling factors. If sourcing your own cooler, a service fouling factor should be applied according to the cooler manufacturer's recommendation.
- ⁴ Consult option notes for flow specifications of optional Cummins seawater pumps, if applicable.
- ⁵ May not be at rated load and speed. Maximum heat rejection may occur at other than rated conditions.

CUMMINS ENGINE COMPANY, INC
 COLUMBUS, INDIANA

All Data is Subject to Change Without Notice - Consult the following Cummins intranet site for most recent data:

<http://marine.cummins.com/>

11. Appendix D

Test ID	Date	Time	Fuel	Engine Hours	Engine Speed	Exhaust Manifold		Instantaneous Fuel Flow	Intake Manifold		Percent Load @ Engine Speed
						Pressure	Temp		Pressure	Temp	
	mm/dd/yy	hh:mm:ss		hh:mm:ss	rpm	In Hg	°F	gph	In Hg	°F	%
ISO_100%_B50_1	2/24/2009	9:30:11	B50	3556:14:46	1869	0	21	24.6	39.7	132	96
ISO_100%_B50_2	2/24/2009	14:40:15	B50	3560:26:12	1868	0	545	24.3	37.8	131	94
ISO_100%_B50_3	2/25/2009	10:37:30	B50	3565:04:25	1861	0	534	24.8	38.8	131	98
ISO_75%_B50_1	2/24/2009	9:51:30	B50	3556:36:05	1715	0	545	19.0	26.6	129	72
ISO_75%_B50_2	2/24/2009	14:55:00	B50	3560:41:25	1728	0	551	18.9	26.2	128	72
ISO_75%_B50_3	2/25/2009	10:53:45	B50	3565:20:40	1733	0	549	19.9	27.3	129	75
ISO_75%_B50_4	2/25/2009	11:08:15	B50	3565:35:11	1732	0	550	19.6	26.9	129	75
ISO_50%_B50_1	2/24/2009	10:11:00	B50	3556:55:35	1512	0	558	13.1	14.4	130	51
ISO_50%_B50_2	2/24/2009	15:08:00	B50	3560:53:57	1522	0	560	13.0	14.1	130	50
ISO_50%_B50_3	2/25/2009	11:24:15	B50	0:00:00	1530	0	0	14.3	14.0	129	56
ISO_25%_B50_1	2/24/2009	10:29:45	B50	3557:14:20	1208	0	425	6.9	5.0	131	42
ISO_25%_B50_2	2/24/2009	15:22:15	B50	3561:08:12	1205	0	446	7.2	5.1	131	44
ISO_25%_B50_3	2/25/2009	11:42:00	B50	3566:08:28	1203	0	426	7.1	4.8	132	43
Idle_B50_1	2/24/2009	11:16:30	B50	3558:01:05	650	0	204	2.1	0.1	135	41
Idle_B50_2	2/25/2009	12:15:15	B50	3566:42:10	650	0	211	2.1	0.2	135	40
ISO_100%_B20_1	2/24/2009	15:52:00	B20	3561:32:07	1871	0	548	24.5	38.4	132	95
ISO_100%_B20_2	2/25/2009	8:48:00	B20	3563:19:13	1868	0	529	24.1	40.1	132	93
ISO_75%_B20_1	2/24/2009	16:06:45	B20	3561:47:18	1729	0	556	19.2	26.8	128	72
ISO_75%_B20_2	2/25/2009	9:03:30	B20	3563:34:43	1733	0	544	19.1	28.0	131	72
ISO_75%_B20_3	2/25/2009	9:18:00	B20	3563:49:13	1732	0	544	19.1	27.1	130	72

Test ID	Date	Time	Fuel	Engine Hours	Engine Speed	Exhaust Manifold		Instantaneous Fuel Flow	Intake Manifold		Percent Load @ Engine Speed
						Pressure	Temp		Pressure	Temp	
	mm/dd/yy	hh:mm:ss		hh:mm:ss	rpm	In Hg	°F	gph	In Hg	°F	%
ISO_50%_B20_1	2/24/2009	16:19:15	B20	3561:59:22	1525	0	565	13.7	14.5	130	54
ISO_50%_B20_2	2/25/2009	9:30:45	B20	3564:01:28	1532	0	561	13.8	15.3	130	55
ISO_25%_B20_1	2/24/2009	16:33:15	B20	3562:13:22	1199	0	442	7.1	4.9	131	43
ISO_25%_B20_2	2/25/2009	9:45:00	B20	3564:16:13	1206	0	443	7.3	5.1	131	44
Idle_B20_1	2/24/2009	16:48:00	B20	3562:28:07	650	0	174	1.6	0.1	133	27
Idle_B20_2	2/25/2009	10:00:30	B20	3564:31:43	650	0	170	1.6	0.0	133	27
ISO_100%_B0_1	2/24/2009	12:05:30	B0	0:00:00	1870	0	0	25.7	40.0	131	93
ISO_100%_B0_2	2/25/2009	13:45:00	B0	3567:11:09	1874	0	547	24.4	38.9	132	94
ISO_75%_B0_1	2/24/2009	12:27:15	B0	3558:50:39	1729	0	558	19.4	27.8	128	74
ISO_75%_B0_2	2/25/2009	13:59:30	B0	3567:25:40	1727	0	553	19.4	26.8	128	73
ISO_75%_B0_3	2/25/2009	14:13:45	B0	3567:39:11	1724	0	555	19.8	26.7	130	75
ISO_50%_B0_1	2/24/2009	12:46:15	B0	3559:09:39	1524	0	572	13.9	15.4	130	55
ISO_50%_B0_2	2/25/2009	14:33:30	B0	3567:55:01	1526	0	583	14.6	16.2	131	58
ISO_25%_B0_1	2/24/2009	13:03:30	B0	3559:26:54	1201	0	435	7.1	4.9	131	43
ISO_25%_B0_2	2/25/2009	14:47:45	B0	3568:09:15	1196	0	413	6.6	4.5	132	41
Idle_B0_1	2/24/2009	13:33:30	B0	3559:56:54	650	0	220	2.2	0.2	134	41
Idle_B0_2	2/25/2009	15:02:30	B0	3568:24:00	650	0	174	1.6	0.0	133	28

Test ID	Engine Speed	Percent Load @ Engine Speed	Max Engine Load @ Engine Speed	Actual Engine Load	% Max Engine Load	Intake Manifold		Engine Displacement	Std. Correction (Pa*Tstd)/(Pstd*Ta)	Calc Exhaust Flow
						Pressure	Temp			
	rpm	%	hp	hp		bar	°C	lit		scfm
ISO_100%_B50_1	1869	96	500	479	96%	1.34	55.8	18.9	2.07	1292
ISO_100%_B50_2	1868	94	500	472	94%	1.28	55.3	18.9	2.02	1259
ISO_100%_B50_3	1861	98	500	489	98%	1.31	55.0	18.9	2.05	1275
ISO_75%_B50_1	1715	72	496	355	71%	0.90	53.9	18.9	1.69	969
ISO_75%_B50_2	1728	72	496	357	71%	0.89	53.5	18.9	1.68	970
ISO_75%_B50_3	1733	75	497	373	75%	0.93	54.1	18.9	1.71	991
ISO_75%_B50_4	1732	75	497	373	75%	0.91	54.1	18.9	1.70	983
ISO_50%_B50_1	1512	51	492	250	50%	0.49	54.5	18.9	1.33	669
ISO_50%_B50_2	1522	50	490	244	49%	0.48	54.3	18.9	1.32	668
ISO_50%_B50_3	1530	56	488	276	55%	0.47	53.9	18.9	1.32	672
ISO_25%_B50_1	1208	42	320	134	27%	0.17	55.2	18.9	1.04	420
ISO_25%_B50_2	1205	44	318	140	28%	0.17	55.2	18.9	1.04	420
ISO_25%_B50_3	1203	43	316	137	27%	0.16	55.3	18.9	1.04	416
Idle_B50_1	650	41	0	45	9%	0.00	57.3	18.9	0.89	193
Idle_B50_2	650	40	0	44	9%	0.01	57.1	18.9	0.89	194
ISO_100%_B20_1	1871	95	500	476	95%	1.30	55.3	18.9	2.04	1273
ISO_100%_B20_2	1868	93	500	465	93%	1.36	55.5	18.9	2.09	1301
ISO_75%_B20_1	1729	72	496	359	72%	0.91	53.4	18.9	1.70	982
ISO_75%_B20_2	1733	72	497	359	72%	0.95	55.1	18.9	1.73	1000
ISO_75%_B20_3	1732	72	497	359	72%	0.92	54.7	18.9	1.70	985

Test ID	Engine Speed	Percent Load @ Engine Speed	Max Engine Load @ Engine Speed	Actual Engine Load	% Max Engine Load	Intake Manifold		Engine Displacement	Std. Correction (Pa*Tstd)/(Pstd*Ta)	Calc Exhaust Flow
						Pressure	Temp			
	rpm	%	hp	hp		bar	°C	lit		scfm
ISO_50%_B20_1	1525	54	489	264	53%	0.49	54.2	18.9	1.33	677
ISO_50%_B20_2	1532	55	488	267	53%	0.52	54.4	18.9	1.35	691
ISO_25%_B20_1	1199	43	313	136	27%	0.17	55.2	18.9	1.04	416
ISO_25%_B20_2	1206	44	318	141	28%	0.17	55.2	18.9	1.04	420
Idle_B20_1	650	27	0	28	6%	0.00	56.3	18.9	0.89	194
Idle_B20_2	650	27	0	28	6%	0.00	56.3	18.9	0.89	193
ISO_100%_B0_1	1870	93	500	465	93%	1.35	55.0	18.9	2.09	1302
ISO_100%_B0_2	1874	94	500	471	94%	1.32	55.3	18.9	2.05	1284
ISO_75%_B0_1	1729	74	496	366	73%	0.94	53.3	18.9	1.73	1000
ISO_75%_B0_2	1727	73	496	364	73%	0.91	53.5	18.9	1.70	980
ISO_75%_B0_3	1724	75	496	370	74%	0.90	54.4	18.9	1.69	974
ISO_50%_B0_1	1524	55	489	269	54%	0.52	54.2	18.9	1.36	690
ISO_50%_B0_2	1526	58	489	284	57%	0.55	54.8	18.9	1.38	702
ISO_25%_B0_1	1201	43	315	136	27%	0.17	55.2	18.9	1.04	416
ISO_25%_B0_2	1196	41	312	126	25%	0.15	55.4	18.9	1.03	409
Idle_B0_1	650	41	0	31	6%	0.01	56.7	18.9	0.90	194
Idle_B0_2	650	28	0	31	6%	0.00	56.3	18.9	0.89	193

Test ID	Date	% Max Engine Load	Zero Offset			Calibration Correction			Dilution Ratio by CO ₂	Dilution Ratio by NO _x
			NO _x	CO	CO ₂	NO _x	CO	CO ₂		
	mm/dd/yy		ppm	ppm	%					
ISO_100%_B50_1	2/24/2009	96%	1.0	1.2	0.02	1.07	1.02	1.00	1.9	1.8
ISO_100%_B50_2	2/24/2009	94%	1.0	1.2	0.02	1.07	1.02	1.00	2.7	2.5
ISO_100%_B50_3	2/25/2009	98%	2.5	-2.3	0.01	1.07	1.03	1.03	2.8	2.6
ISO_75%_B50_1	2/24/2009	71%	1.0	1.2	0.02	1.07	1.02	1.00	2.1	2.1
ISO_75%_B50_2	2/24/2009	71%	1.0	1.2	0.02	1.07	1.02	1.00	2.9	2.8
ISO_75%_B50_3	2/25/2009	75%	2.5	-2.3	0.01	1.07	1.03	1.03	3.0	2.9
ISO_75%_B50_4	2/25/2009	75%	2.5	-2.3	0.01	1.07	1.03	1.03	3.0	2.9
ISO_50%_B50_1	2/24/2009	50%	1.0	1.2	0.02	1.07	1.02	1.00	2.4	2.4
ISO_50%_B50_2	2/24/2009	49%	1.0	1.2	0.02	1.07	1.02	1.00	3.1	3.0
ISO_50%_B50_3	2/25/2009	55%	2.5	-2.3	0.01	1.07	1.03	1.03	3.2	3.1
ISO_25%_B50_1	2/24/2009	27%	1.0	1.2	0.02	1.07	1.02	1.00	2.7	n/a
ISO_25%_B50_2	2/24/2009	28%	1.0	1.2	0.02	1.07	1.02	1.00	3.2	3.1
ISO_25%_B50_3	2/25/2009	27%	2.5	-2.3	0.01	1.07	1.03	1.03	3.3	3.1
Idle_B50_1	2/24/2009	9%	1.0	1.2	0.02	1.07	1.02	1.00	3.4	3.1
Idle_B50_2	2/25/2009	9%	2.5	-2.3	0.01	1.07	1.03	1.03	3.1	2.9
ISO_100%_B20_1	2/24/2009	95%	1.0	1.2	0.02	1.07	1.02	1.00	2.7	2.6
ISO_100%_B20_2	2/25/2009	93%	2.5	-2.3	0.01	1.07	1.03	1.03	2.8	2.7
ISO_75%_B20_1	2/24/2009	72%	1.0	1.2	0.02	1.07	1.02	1.00	3.0	2.8
ISO_75%_B20_2	2/25/2009	72%	2.5	-2.3	0.01	1.07	1.03	1.03	3.0	3.2
ISO_75%_B20_3	2/25/2009	72%	2.5	-2.3	0.01	1.07	1.03	1.03	3.0	3.2

Test ID	Date	% Max Engine Load	Zero Offset			Calibration Correction			Dilution Ratio by CO ₂	Dilution Ratio by NO _x
			NO _x	CO	CO ₂	NO _x	CO	CO ₂		
	mm/dd/yy		ppm	ppm	%					
ISO_50%_B20_1	2/24/2009	53%	1.0	1.2	0.02	1.07	1.02	1.00	3.2	3.1
ISO_50%_B20_2	2/25/2009	53%	2.5	-2.3	0.01	1.07	1.03	1.03	3.2	3.2
ISO_25%_B20_1	2/24/2009	27%	1.0	1.2	0.02	1.07	1.02	1.00	3.2	3.1
ISO_25%_B20_2	2/25/2009	28%	2.5	-2.3	0.01	1.07	1.03	1.03	3.3	3.2
Idle_B20_1	2/24/2009	6%	1.0	1.2	0.02	1.07	1.02	1.00	3.0	2.9
Idle_B20_2	2/25/2009	6%	2.5	-2.3	0.01	1.07	1.03	1.03	3.3	3.3
ISO_100%_B0_1	2/24/2009	93%	1.0	1.2	0.02	1.07	1.02	1.00	2.8	2.6
ISO_100%_B0_2	2/25/2009	94%	2.5	-2.3	0.01	1.07	1.03	1.03	2.8	2.6
ISO_75%_B0_1	2/24/2009	73%	1.0	1.2	0.02	1.07	1.02	1.00	2.9	2.9
ISO_75%_B0_2	2/25/2009	73%	2.5	-2.3	0.01	1.07	1.03	1.03	3.0	2.8
ISO_75%_B0_3	2/25/2009	74%	2.5	-2.3	0.01	1.07	1.03	1.03	3.0	2.7
ISO_50%_B0_1	2/24/2009	54%	1.0	1.2	0.02	1.07	1.02	1.00	3.2	3.1
ISO_50%_B0_2	2/25/2009	57%	2.5	-2.3	0.01	1.07	1.03	1.03	3.1	n/a
ISO_25%_B0_1	2/24/2009	27%	1.0	1.2	0.02	1.07	1.02	1.00	3.2	3.1
ISO_25%_B0_2	2/25/2009	25%	2.5	-2.3	0.01	1.07	1.03	1.03	3.2	3.0
Idle_B0_1	2/24/2009	6%	1.0	1.2	0.02	1.07	1.02	1.00	3.0	n/a
Idle_B0_2	2/25/2009	6%	2.5	-2.3	0.01	1.07	1.03	1.03	3.4	3.2

Red Font: Dilution Ratio Estimated from tests on same day

Test ID	Ambient Temp	Ambient Pressure	Relative Humidity	Ambient Pressure	Ambient Temp	Saturation Water Pressure	Absolute Humidity	Humidity Correction K _{NOx}	Humidity Correction K _{PM}
	°F	in Hg		kPa	K	kPa			
ISO_100%_B50_1	54	30.2	78	102.3	285	1.40	6.7	0.92	1.06
ISO_100%_B50_2	63.5	30.12	51	102.0	291	1.96	6.2	0.93	1.06
ISO_100%_B50_3	56.1	30.16	77	102.1	286	1.51	7.2	0.93	1.05
ISO_75%_B50_1	54	30.2	78	102.3	285	1.40	6.7	0.92	1.06
ISO_75%_B50_2	62.5	30.12	52	102.0	290	1.90	6.1	0.93	1.07
ISO_75%_B50_3	56.5	30.16	76	102.1	287	1.53	7.2	0.93	1.05
ISO_75%_B50_4	56.4	30.16	74	102.1	287	1.52	6.9	0.93	1.05
ISO_50%_B50_1	54	30.2	78	102.3	285	1.40	6.7	0.92	1.06
ISO_50%_B50_2	62.2	30.12	52	102.0	290	1.88	6.0	0.93	1.07
ISO_50%_B50_3	56.8	30.17	75	102.2	287	1.55	7.1	0.93	1.05
ISO_25%_B50_1	58.5	30.19	72	102.2	288	1.64	7.3	0.94	1.05
ISO_25%_B50_2	61.3	30.12	53	102.0	289	1.82	5.9	0.92	1.07
ISO_25%_B50_3	57.7	30.16	73	102.1	287	1.60	7.2	0.93	1.05
Idle_B50_1	59.7	30.19	70	102.2	288	1.72	7.4	0.94	1.05
Idle_B50_2	59.5	30.16	69	102.1	288	1.70	7.2	0.94	1.05
ISO_100%_B20_1	61.2	30.11	54	102.0	289	1.81	6.0	0.93	1.07
ISO_100%_B20_2	51.7	30.15	76	102.1	284	1.28	6.0	0.91	1.07
ISO_75%_B20_1	60.9	30.11	54	102.0	289	1.79	6.0	0.92	1.07
ISO_75%_B20_2	51.9	30.15	76	102.1	284	1.29	6.0	0.91	1.07
ISO_75%_B20_3	52.5	30.15	76	102.1	284	1.32	6.2	0.92	1.06

Test ID	Ambient Temp	Ambient Pressure	Relative Humidity	Ambient Pressure	Ambient Temp	Saturation Water Pressure	Absolute Humidity	Humidity Correction K _{NOx}	Humidity Correction K _{PM}
	°F	in Hg		kPa	K	kPa			
ISO_50%_B20_1	60.7	30.1	54	101.9	289	1.78	5.9	0.92	1.07
ISO_50%_B20_2	52.8	30.15	77	102.1	285	1.34	6.3	0.92	1.06
ISO_25%_B20_1	60.3	30.09	54	101.9	289	1.75	5.8	0.92	1.07
ISO_25%_B20_2	52.9	30.15	77	102.1	285	1.34	6.4	0.92	1.06
Idle_B20_1	59.6	30.09	53	101.9	288	1.71	5.6	0.92	1.07
Idle_B20_2	53.8	30.15	77	102.1	285	1.39	6.6	0.92	1.06
ISO_100%_B0_1	61.9	30.18	52	102.2	290	1.86	5.9	0.93	1.07
ISO_100%_B0_2	59.8	30.14	64	102.1	288	1.72	6.8	0.93	1.05
ISO_75%_B0_1	62.3	30.18	52	102.2	290	1.88	6.0	0.93	1.07
ISO_75%_B0_2	59.7	30.14	64	102.1	288	1.72	6.8	0.93	1.06
ISO_75%_B0_3	59.7	30.14	66	102.1	288	1.72	7.0	0.93	1.05
ISO_50%_B0_1	62.4	30.17	51	102.2	290	1.89	5.9	0.93	1.07
ISO_50%_B0_2	60.1	30.14	66	102.1	289	1.74	7.1	0.94	1.05
ISO_25%_B0_1	62.6	30.17	51	102.2	290	1.90	6.0	0.93	1.07
ISO_25%_B0_2	60.2	30.14	66	102.1	289	1.75	7.1	0.94	1.05
Idle_B0_1	62.7	30.14	49	102.1	290	1.91	5.8	0.92	1.07
Idle_B0_2	60.6	30.15	66	102.1	289	1.77	7.2	0.94	1.05

Test ID	Load	Dilute Gas Conc. from Instrument			Dilute Gas Conc. After Calibration & Ambient Correc.			Raw Gas Conc. Includes Humidity Correc.			Raw Gas Emission Factors		
		NO _x	CO	CO ₂	NO _x	CO	CO ₂	NO _x	CO	CO ₂	NO _x	CO	CO ₂
	hp	ppm	ppm	%	ppm	ppm	%	g/hr	g/hr	kg/hr	g/hp-hr	g/hp-hr	g/hp-hr
ISO_100%_B50_1	479	350	53	3.88	373	52	3.84	2661	246	284	5.56	0.51	593
ISO_100%_B50_2	472	265	55	2.75	282	55	2.70	2858	365	281	6.05	0.77	596
ISO_100%_B50_3	489	245	38	2.58	260	41	2.61	2749	284	284	5.62	0.58	580
ISO_75%_B50_1	355	285	229	3.47	303	232	3.42	1839	927	215	5.19	2.61	607
ISO_75%_B50_2	357	228	170	2.52	243	171	2.47	2056	951	216	5.76	2.66	606
ISO_75%_B50_3	373	220	163	2.41	233	170	2.43	2082	991	223	5.58	2.66	599
ISO_75%_B50_4	373	219	159	2.38	233	165	2.41	2042	951	217	5.48	2.55	583
ISO_50%_B50_1	250	250	52	3.08	266	52	3.04	1274	164	151	5.09	0.66	603
ISO_50%_B50_2	244	202	43	2.38	215	43	2.33	1337	174	150	5.48	0.71	613
ISO_50%_B50_3	276	198	38	2.28	210	42	2.29	1348	175	152	4.89	0.64	550
ISO_25%_B50_1	134	199	28	2.25	212	27	2.21	722	60	77	5.40	0.45	575
ISO_25%_B50_2	140	184	26	1.97	195	25	1.92	780	66	79	5.57	0.47	566
ISO_25%_B50_3	137	170	21	1.82	180	24	1.82	726	64	75	5.32	0.47	552
Idle_B50_1	45	141	35	1.37	150	35	1.32	294	44	26	6.60	0.99	592
Idle_B50_2	44	157	35	1.41	166	38	1.40	298	44	26	6.83	1.01	592
ISO_100%_B20_1	476	252	54	2.71	269	54	2.67	2739	363	281	5.75	0.76	590
ISO_100%_B20_2	465	221	60	2.54	234	63	2.56	2454	443	281	5.28	0.95	605
ISO_75%_B20_1	359	218	171	2.46	232	172	2.41	2026	988	217	5.64	2.75	605
ISO_75%_B20_2	359	196	164	2.36	208	170	2.38	1831	1000	220	5.09	2.78	611
ISO_75%_B20_3	359	199	167	2.35	210	174	2.37	1842	1011	217	5.13	2.82	604

Test ID	Load	Dilute Gas Conc. from Instrument			Dilute Gas Conc. After Calibration & Ambient Correc.			Raw Gas Conc. Includes Humidity Correc.			Raw Gas Emission Factors		
		NO _x	CO	CO ₂	NO _x	CO	CO ₂	NO _x	CO	CO ₂	NO _x	CO	CO ₂
	Hp	ppm	ppm	%	ppm	ppm	%	g/hr	g/hr	kg/hr	g/hp-hr	g/hp-hr	g/hp-hr
ISO_50%_B20_1	264	193	51	2.33	205	50	2.28	1311	212	151	4.97	0.80	571
ISO_50%_B20_2	267	183	42	2.26	194	45	2.27	1270	197	155	4.76	0.74	582
ISO_25%_B20_1	136	178	26	1.92	189	26	1.87	733	66	75	5.41	0.49	555
ISO_25%_B20_2	141	167	20	1.87	176	23	1.88	705	61	78	5.02	0.44	558
Idle_B20_1	28	95	29	0.98	100	29	0.92	172	33	17	6.19	1.17	595
Idle_B20_2	28	87	23	0.88	91	26	0.87	170	32	17	6.02	1.12	595
ISO_100%_B0_1	465	234	72	2.62	248	72	2.57	2641	501	283	5.68	1.08	608
ISO_100%_B0_2	471	238	51	2.56	253	55	2.58	2667	378	280	5.66	0.80	593
ISO_75%_B0_1	366	206	168	2.46	219	170	2.41	1905	970	217	5.21	2.65	592
ISO_75%_B0_2	364	208	169	2.36	220	175	2.38	1914	996	213	5.26	2.74	584
ISO_75%_B0_3	370	220	163	2.41	233	170	2.43	2012	954	215	5.44	2.58	581
ISO_50%_B0_1	269	188	57	2.34	200	57	2.29	1307	245	155	4.85	0.91	576
ISO_50%_B0_2	284	612	188	7.39	654	195	7.55	1370	266	162	4.82	0.93	569
ISO_25%_B0_1	136	164	28	1.90	175	27	1.85	694	71	76	5.10	0.52	557
ISO_25%_B0_2	126	161	25	1.76	170	28	1.76	672	72	71	5.32	0.57	563
Idle_B0_1	31	n/a	n/a	n/a	n/a	n/a	n/a	n/a	n/a	n/a	n/a	n/a	n/a
Idle_B0_2	31	92	25	0.91	96	28	0.89	190	36	18	6.18	1.17	588

Blue font: Raw Gas Concentrations, Dilute not Measured

Test ID	Sample ID		Flow Rates		Sample Time		PM Mass	EC	OC
	Teflo	Quartz	Teflo	Quartz	Teflo	Quartz			
			lit/min	lit/min	min	min	mg/filter	ug/filter	ug/filter
ISO_100%_B50_1	SS090005	SSQ090201	17.2	15.2	9	9	1.2317	323	732
ISO_100%_B50_2	SS060916	SSQ090221	16.6	15.2	7	7	0.68435	155	299
ISO_100%_B50_3	SS060915	SSQ090251	15.9	15.2	7	7	0.74215	207	296
ISO_75%_B50_1	SS090014	SSQ090203	15.8	15.2	9	9	1.1408	373	435
ISO_75%_B50_2	SS090024	SSQ090223	14.5	15.6	7	7	0.71085	236	262
ISO_75%_B50_3	SS060873	SSQ090253	16.6	15.2	7	7	0.73615	234	297
ISO_75%_B50_4	SS060919	SSQ090255	15.8	15.6	7	7	0.75195	233	318
ISO_50%_B50_1	SS060747	SSQ090205	15.8	15.2	9	9	0.7177	219	343
ISO_50%_B50_2	SS060917	SSQ090225	14.5	15.6	7	7	0.5173	138	246
ISO_50%_B50_3	SS090007	SSQ090257	16.3	15.2	7.5	7.5	0.52965	162	254
ISO_25%_B50_1	SS060863	SSQ090207	16.6	15.6	9	9	0.72825	87	430
ISO_25%_B50_2	SS060918	SSQ090227	15.9	15.6	7	7	0.44805	61	259
ISO_25%_B50_3	SS060839	SSQ090259	16.6	15.2	7	7	0.4482	63	277
Idle_B50_1	APL138	SSQ090209	16.6	15.6	9	9	1.07945	336	411
Idle_B50_2	SS090021	SSQ090261	16.6	14.9	7	7	0.70945	246	291
ISO_100%_B20_1	APL169	SSQ090229	16.6	15.6	7	7	0.78115	276	315
ISO_100%_B20_2	SS090002	SSQ090239	16.6	14.9	7	7	0.7369	275	251
ISO_75%_B20_1	SS060914	SSQ090231	14.8	15.2	7	7	0.8438	356	283
ISO_75%_B20_2	SS090015	SSQ090241	15.9	14.9	7	7	0.7569	302	286
ISO_75%_B20_3	SS090016	SSQ090243	15.8	15.6	7	7	0.7884	261	337

Test ID	Sample ID		Flow Rates		Sample Time		PM Mass	EC	OC
	Teflo	Quartz	Teflo	Quartz	Teflo	Quartz			
			lit/min	lit/min	min	min	mg/filter	ug/filter	ug/filter
ISO_50%_B20_1	SS090023	SSQ090233	15.5	15.2	7	7	0.5444	243	227
ISO_50%_B20_2	SS090013	SSQ090245	15.1	15.2	7	7	0.5448	199	248
ISO_25%_B20_1	SS090003	SSQ090235	16.6	15.2	7	7	0.3339	77	233
ISO_25%_B20_2	SS090011	SSQ090247	15.9	15.2	7	7	0.3594	84	226
Idle_B20_1	SS090022	SSQ090237	16.5	15.6	7	7	0.50245	249	196
Idle_B20_2	SS090017	SSQ090249	16.6	15.2	7	7	0.4693	217	195
ISO_100%_B0_1	SS090004	SSQ090211	17.5	16.0	9.25	9.25	1.3174	347	587
ISO_100%_B0_2	SS090020	SSQ090263	16.5	14.9	7	7	0.8946	299	350
ISO_75%_B0_1	SS060754	SSQ090213	15.9	15.2	9	9	1.347	567	464
ISO_75%_B0_2	SS090019	SSQ090265	16.6	14.9	7.5	7.5	1.0879	385	450
ISO_75%_B0_3	SS090018	SSQ090267	15.9	14.9	7	7	1.065	316	500
ISO_50%_B0_1	SS060909	SSQ090215	16.5	15.6	9	9	0.97635	317	430
ISO_50%_B0_2	SS060920	SSQ090269	16.6	15.2	7	7	0.73005	393	194
ISO_25%_B0_1	SS060913	SSQ090217	16.2	15.6	9	9	0.45675	123	270
ISO_25%_B0_2	SS060887	SSQ090271	15.9	14.9	7	7	0.33485	94	198
Idle_B0_1	SS060862	SSQ090219	15.9	15.6	9	9	0.9821	445	305
Idle_B0_2	SS060845	SSQ090273	15.9	14.9	7	7	0.5605	268	197

Test ID	Load	Avg. DustTrak Reading Dilute Gas	Dilute PM Conc. From Teflo Filter	PM	EC	OC	PM	EC	OC
	hp	mg/m ³	mg/m ³	g/hr	g/hr	g/hr	g/hp-hr	g/hp-hr	g/hp-hr
ISO_100%_B50_1	479	9.8	8.0	34.3	10.1	22.9	0.072	0.021	0.048
ISO_100%_B50_2	472	4.86	5.9	35.9	8.8	17.1	0.076	0.019	0.036
ISO_100%_B50_3	489	6.94	6.7	42.0	12.2	17.4	0.086	0.025	0.036
ISO_75%_B50_1	355	9.2	8.0	29.2	9.9	11.6	0.082	0.028	0.033
ISO_75%_B50_2	357	5.24	7.0	35.8	11.1	12.3	0.100	0.031	0.034
ISO_75%_B50_3	373	6.76	6.3	33.6	11.6	14.8	0.090	0.031	0.040
ISO_75%_B50_4	373	7.59	6.8	35.5	11.2	15.2	0.095	0.030	0.041
ISO_50%_B50_1	250	4.07	5.0	14.5	4.6	7.2	0.058	0.018	0.029
ISO_50%_B50_2	244	2.42	5.1	19.2	4.7	8.5	0.079	0.019	0.035
ISO_50%_B50_3	276	n/a	4.3	16.5	5.4	8.5	0.060	0.020	0.031
ISO_25%_B50_1	134	2.04	4.9	9.8	1.2	6.1	0.073	0.009	0.046
ISO_25%_B50_2	140	1.12	4.0	9.8	1.4	5.7	0.070	0.010	0.041
ISO_25%_B50_3	137	1.44	3.9	9.2	1.4	6.2	0.068	0.010	0.045
Idle_B50_1	45	9.5	7.2	8.3	2.7	3.4	0.187	0.062	0.075
Idle_B50_2	44	6.54	6.1	6.5	2.5	3.0	0.148	0.057	0.068
ISO_100%_B20_1	476	7.18	6.7	41.6	15.6	17.8	0.087	0.033	0.037
ISO_100%_B20_2	465	6.23	6.3	40.9	17.0	15.5	0.088	0.037	0.033
ISO_75%_B20_1	359	6.73	8.1	43.1	17.7	14.0	0.120	0.049	0.039
ISO_75%_B20_2	359	6.51	6.8	36.8	15.7	14.9	0.103	0.044	0.041
ISO_75%_B20_3	359	6.79	7.1	38.1	12.8	16.5	0.106	0.036	0.046

Test ID	Load	Avg. DustTrak Reading Dilute Gas	Dilute PM Conc. From Teflo Filter	PM	EC	OC	PM	EC	OC
	hp	mg/m ³	mg/m ³	g/hr	g/hr	g/hr	g/hp-hr	g/hp-hr	g/hp-hr
ISO_50%_B20_1	264	3.62	5.0	19.4	8.8	8.2	0.074	0.033	0.031
ISO_50%_B20_2	267	4.24	5.1	20.5	7.4	9.3	0.077	0.028	0.035
ISO_25%_B20_1	136	1.45	2.9	6.8	1.7	5.2	0.050	0.013	0.038
ISO_25%_B20_2	141	1.81	3.2	7.9	1.9	5.2	0.056	0.014	0.037
Idle_B20_1	28	4.47	4.3	4.6	2.4	1.9	0.165	0.087	0.068
Idle_B20_2	28	4.69	4.1	4.6	2.3	2.1	0.162	0.081	0.073
ISO_100%_B0_1	465	0	8.1	52.5	15.2	25.6	0.113	0.033	0.055
ISO_100%_B0_2	471	9.5	7.7	48.6	18.0	21.1	0.103	0.038	0.045
ISO_75%_B0_1	366	8.6	9.4	49.7	21.8	17.8	0.136	0.060	0.049
ISO_75%_B0_2	364	8.75	8.7	45.3	17.9	20.9	0.124	0.049	0.057
ISO_75%_B0_3	370	9.3	9.6	48.9	15.5	24.6	0.132	0.042	0.066
ISO_50%_B0_1	269	6.4	6.6	26.1	9.0	12.1	0.097	0.033	0.045
ISO_50%_B0_2	284	5.42	6.3	24.0	14.0	6.9	0.084	0.049	0.024
ISO_25%_B0_1	136	1.86	3.1	7.5	2.1	4.6	0.055	0.016	0.034
ISO_25%_B0_2	126	1.83	3.0	7.0	2.1	4.4	0.056	0.017	0.035
Idle_B0_1	31	7.81	6.9	7.3	3.4	2.3	0.237	0.109	0.075
Idle_B0_2	31	5.29	5.0	5.9	3.0	2.2	0.191	0.098	0.072

Test ID	Date	Time	% Max Engine Load	NO _x	CO	CO ₂	PM	EC	OC
	mm/dd/yy	hh:mm:ss	%	g/hr	g/hr	kg/hr	g/hr	g/hr	g/hr
ISO_100%_B50_1	02/24/09	9:30:11	96%	2661	246	284	34.3	10.1	22.9
ISO_100%_B50_2	02/24/09	14:40:15	94%	2858	365	281	35.9	8.8	17.1
ISO_100%_B50_3	02/25/09	10:37:30	98%	2749	284	284	42.0	12.2	17.4
			Average	2756	298	283	38.9	10.5	17.2
			Stdev or Range	98	61	2	3.0	1.7	0.2
			% Error	4%	20%	1%	8%	16%	1%
ISO_75%_B50_1	02/24/09	9:51:30	71%	1839	927	215	29.2	9.9	11.6
ISO_75%_B50_2	02/24/09	14:55:00	71%	2056	951	216	35.8	11.1	12.3
ISO_75%_B50_3	02/25/09	10:53:45	75%	2082	991	223	33.6	11.6	14.8
ISO_75%_B50_4	02/25/09	11:08:15	75%	2042	951	217	35.5	11.2	15.2
			Average	2005	955	218	35.0	11.3	14.1
			Stdev or Range	112	27	4	1.2	0.3	1.6
			% Error	6%	3%	2%	3%	3%	11%
ISO_50%_B50_1	02/24/09	10:11:00	50%	1274	164	151	14.5	4.6	7.2
ISO_50%_B50_2	02/24/09	15:08:00	49%	1337	174	150	19.2	4.7	8.5
ISO_50%_B50_3	02/25/09	11:24:15	55%	1348	175	152	16.5	5.4	8.5
			Average	1320	171	151	17.9	5.1	8.5
			Stdev or Range	40	6	1	1.3	0.3	0.0
			% Error	3%	4%	1%	7%	7%	0%
ISO_25%_B50_1	02/24/09	10:29:45	27%	722	60	77	9.8	1.2	6.1
ISO_25%_B50_2	02/24/09	15:22:15	28%	780	66	79	9.8	1.4	5.7
ISO_25%_B50_3	02/25/09	11:42:00	27%	726	64	75	9.2	1.4	6.2
			Average	742	63	77	9.6	1.3	6.0
			Stdev or Range	32	3	2	0.3	0.1	0.2
			% Error	4%	5%	3%	3%	7%	4%
Idle_B50_1	02/24/09	11:16:30	9%	294	44	26	8.3	2.7	3.4
Idle_B50_2	02/25/09	12:15:15	9%	298	44	26	6.5	2.5	3.0
			Average	296.1	44.3	26.1	7.4	2.6	3.2
			Stdev or Range	1.9	0.0	0.3	0.9	0.1	0.2
			% Error	1%	0%	1%	12%	5%	6%

Red font: Invalid Test

Test ID	Date	Time	% Max Engine Load	NO _x	CO	CO ₂	PM	EC	OC
	mm/dd/yy	hh:mm:ss	%	g/hr	g/hr	kg/hr	g/hr	g/hr	g/hr
ISO_100%_B20_1	02/24/09	15:52:00	95%	2739	363	281	41.6	15.6	17.8
ISO_100%_B20_2	02/25/09	8:48:00	93%	2454	443	281	40.9	17.0	15.5
			Average	2597	403	281	41.3	16.3	16.7
			Stdev or Range	142	40	0	0.3	0.7	1.1
			% Error	5%	10%	0%	1%	4%	7%
ISO_75%_B20_1	02/24/09	16:06:45	72%	2026	988	217	43.1	17.7	14.0
ISO_75%_B20_2	02/25/09	9:03:30	72%	1831	1000	220	36.8	15.7	14.9
ISO_75%_B20_3	02/25/09	9:18:00	72%	1842	1011	217	38.1	12.8	16.5
			Average	1900	999	218	39.4	15.4	15.1
			Stdev or Range	109	12	1	3.3	2.4	1.3
			% Error	6%	1%	1%	8%	16%	8%
ISO_50%_B20_1	02/24/09	16:19:15	53%	1311	212	151	19.4	8.8	8.2
ISO_50%_B20_2	02/25/09	9:30:45	53%	1270	197	155	20.5	7.4	9.3
			Average	1291	204	153	20.0	8.1	8.8
			Stdev or Range	20	7	2	0.5	0.7	0.5
			% Error	2%	4%	2%	3%	9%	6%
ISO_25%_B20_1	02/24/09	16:33:15	27%	733	66	75	6.8	1.7	5.2
ISO_25%_B20_2	02/25/09	9:45:00	28%	705	61	78	7.9	1.9	5.2
			Average	719	63	77	7.4	1.8	5.2
			Stdev or Range	14	2	2	0.5	0.1	0.0
			% Error	2%	4%	2%	7%	5%	0%
Idle_B20_1	02/24/09	16:48:00	6%	172	33	17	4.6	2.4	1.9
Idle_B20_2	02/25/09	10:00:30	6%	170	32	17	4.6	2.3	2.1
			Average	171	32	17	4.6	2.4	2.0
			Stdev or Range	1	1	0	0.0	0.1	0.1
			% Error	1%	2%	1%	0%	3%	4%

Test ID	Date	Time	% Max Engine Load	NO _x	CO	CO ₂	PM	EC	OC
	mm/dd/yy	hh:mm:ss	%	g/hr	g/hr	kg/hr	g/hr	g/hr	g/hr
ISO_100%_B0_1	02/24/09	12:05:30	93%	2641	501	283	52.5	15.2	25.6
ISO_100%_B0_2	02/25/09	13:45:00	94%	2667	378	280	48.6	18.0	21.1
			Average	2654	439	281	50.5	16.6	23.4
			Stdev or Range	13	61	1	1.9	1.4	2.3
			% Error	0%	14%	1%	4%	9%	10%
ISO_75%_B0_1	02/24/09	12:27:15	73%	1905	970	217	49.7	21.8	17.8
ISO_75%_B0_2	02/25/09	13:59:30	73%	1914	996	213	45.3	17.9	20.9
ISO_75%_B0_3	02/25/09	14:13:45	74%	2012	954	215	48.9	15.5	24.6
			Average	1944	973	215	48.0	18.4	21.1
			Stdev or Range	59	21	2	2.4	3.2	3.4
			% Error	3%	2%	1%	5%	17%	16%
ISO_50%_B0_1	02/24/09	12:46:15	54%	1307	245	155	26.1	9.0	12.1
ISO_50%_B0_2	02/25/09	14:33:30	57%	1370	266	162	24.0	14.0	6.9
			Average	1338	255	159	25.0	11.5	9.5
			Stdev or Range	32	10	3	1.1	2.5	2.6
			% Error	2%	4%	2%	4%	22%	27%
ISO_25%_B0_1	02/24/09	13:03:30	27%	694	71	76	7.5	2.1	4.6
ISO_25%_B0_2	02/25/09	14:47:45	25%	672	72	71	7.0	2.1	4.4
			Average	683	71	74	7.3	2.1	4.5
			Stdev or Range	11	0	2	0.3	0.0	0.1
			% Error	2%	1%	3%	4%	0%	2%
Idle_B0_1	02/24/09	13:33:30	6%	n/a	n/a	n/a	7.3	3.4	2.3
Idle_B0_2	02/25/09	15:02:30	6%	190	36	18	5.9	3.0	2.2
			Average	190	36	18	6.6	3.2	2.3
			Stdev or Range	n/a	n/a	n/a	0.7	0.2	0.0
			% Error	n/a	n/a	n/a	11%	6%	2%

Test ID	Date	Time	% Max Engine Load	NO _x	CO	CO ₂	PM	EC	OC
	mm/dd/yy	hh:mm:ss	%	g/hp-hr	g/hp-hr	g/hp-hr	g/hp-hr	g/hp-hr	g/hp-hr
ISO_100%_B50_1	2/24/09	9:30:11	96%	5.6	0.51	593	0.072	0.021	0.048
ISO_100%_B50_2	2/24/09	14:40:15	94%	6.1	0.77	596	0.076	0.019	0.036
ISO_100%_B50_3	2/25/09	10:37:30	98%	5.6	0.58	580	0.086	0.025	0.036
			Average	5.7	0.62	589	0.081	0.022	0.036
			Stdev or Range	0.3	0.13	8	0.005	0.003	0.000
			% Error	5%	22%	1%	6%	14%	1%
ISO_75%_B50_1	2/24/09	9:51:30	71%	5.2	2.61	607	0.082	0.028	0.033
ISO_75%_B50_2	2/24/09	14:55:00	71%	5.8	2.66	606	0.100	0.031	0.034
ISO_75%_B50_3	2/25/09	10:53:45	75%	5.6	2.66	599	0.090	0.031	0.040
ISO_75%_B50_4	2/25/09	11:08:15	75%	5.5	2.55	583	0.095	0.030	0.041
			Average	5.5	2.62	599	0.095	0.031	0.038
			Stdev or Range	0.2	0.05	11	0.005	0.001	0.003
			% Error	4%	2%	2%	5%	2%	9%
ISO_50%_B50_1	2/24/09	10:11:00	50%	5.1	0.66	603	0.058	0.018	0.029
ISO_50%_B50_2	2/24/09	15:08:00	49%	5.5	0.71	613	0.079	0.019	0.035
ISO_50%_B50_3	2/25/09	11:24:15	55%	4.9	0.64	550	0.060	0.020	0.031
			Average	5.2	0.67	589	0.069	0.020	0.033
			Stdev or Range	0.3	0.04	34	0.009	0.000	0.002
			% Error	6%	6%	6%	13%	1%	6%
ISO_25%_B50_1	2/24/09	10:29:45	27%	5.4	0.45	575	0.073	0.009	0.046
ISO_25%_B50_2	2/24/09	15:22:15	28%	5.6	0.47	566	0.070	0.010	0.041
ISO_25%_B50_3	2/25/09	11:42:00	27%	5.3	0.47	552	0.068	0.010	0.045
			Average	5.4	0.46	564	0.070	0.010	0.044
			Stdev or Range	0.1	0.01	11	0.003	0.001	0.003
			% Error	2%	3%	2%	4%	6%	6%
Idle_B50_1	2/24/09	11:16:30	9%	6.6	0.99	592	0.187	0.062	0.075
Idle_B50_2	2/25/09	12:15:15	9%	6.8	1.01	592	0.148	0.057	0.068
			Average	6.7	1.00	592	0.168	0.060	0.072
			Stdev or Range	0.1	0.01	0	0.019	0.002	0.004
			% Error	2%	1%	0%	11%	4%	5%

Red font: Invalid Test

Test ID	Date	Time	% Max Engine Load	NO _x	CO	CO ₂	PM	EC	OC
	mm/dd/yy	hh:mm:ss	%	g/hp-hr	g/hp-hr	g/hp-hr	g/hp-hr	g/hp-hr	g/hp-hr
ISO_100%_B20_1	2/24/09	15:52:00	95%	5.8	0.76	590	0.087	0.033	0.037
ISO_100%_B20_2	2/25/09	8:48:00	93%	5.3	0.95	605	0.088	0.037	0.033
			Average	5.5	0.86	598	0.088	0.035	0.035
			Stdev or Range	0.2	0.10	7	0.000	0.002	0.002
			% Error	4%	11%	1%	0%	5%	6%
ISO_75%_B20_1	2/24/09	16:06:45	72%	5.6	2.75	605	0.120	0.049	0.039
ISO_75%_B20_2	2/25/09	9:03:30	72%	5.1	2.78	611	0.103	0.044	0.041
ISO_75%_B20_3	2/25/09	9:18:00	72%	5.1	2.82	604	0.106	0.036	0.046
			Average	5.3	2.78	607	0.110	0.043	0.042
			Stdev or Range	0.3	0.03	4	0.009	0.007	0.004
			% Error	6%	1%	1%	9%	16%	8%
ISO_50%_B20_1	2/24/09	16:19:15	53%	5.0	0.80	571	0.074	0.033	0.031
ISO_50%_B20_2	2/25/09	9:30:45	53%	4.8	0.74	582	0.077	0.028	0.035
			Average	4.9	0.77	576	0.075	0.031	0.033
			Stdev or Range	0.1	0.03	6	0.002	0.003	0.002
			% Error	2%	4%	1%	2%	9%	5%
ISO_25%_B20_1	2/24/09	16:33:15	27%	5.4	0.49	555	0.050	0.013	0.038
ISO_25%_B20_2	2/25/09	9:45:00	28%	5.0	0.44	558	0.056	0.014	0.037
			Average	5.2	0.46	557	0.053	0.013	0.037
			Stdev or Range	0.2	0.02	1	0.003	0.000	0.001
			% Error	4%	5%	0%	5%	4%	2%
Idle_B20_1	2/24/09	16:48:00	6%	6.2	1.17	595	0.165	0.087	0.068
Idle_B20_2	2/25/09	10:00:30	6%	6.0	1.12	595	0.162	0.081	0.073
			Average	6.1	1.15	595	0.164	0.084	0.071
			Stdev or Range	0.1	0.03	0	0.002	0.003	0.002
			% Error	1%	2%	0%	1%	3%	3%

Test ID	Date	Time	% Max Engine Load	NO _x	CO	CO ₂	PM	EC	OC
	mm/dd/yy	hh:mm:ss	%	g/hp-hr	g/hp-hr	g/hp-hr	g/hp-hr	g/hp-hr	g/hp-hr
ISO_100%_B0_1	2/24/09	12:05:30	93%	5.7	1.08	608	0.113	0.033	0.055
ISO_100%_B0_2	2/25/09	13:45:00	94%	5.7	0.80	593	0.103	0.038	0.045
			Average	5.7	0.94	601	0.108	0.035	0.050
			Stdev or Range	0.0	0.14	7	0.005	0.003	0.005
			% Error	0%	15%	1%	5%	8%	10%
ISO_75%_B0_1	2/24/09	12:27:15	73%	5.2	2.65	592	0.136	0.060	0.049
ISO_75%_B0_2	2/25/09	13:59:30	73%	5.3	2.74	584	0.124	0.049	0.057
ISO_75%_B0_3	2/25/09	14:13:45	74%	5.4	2.58	581	0.132	0.042	0.066
			Average	5.3	2.66	586	0.131	0.050	0.058
			Stdev or Range	0.1	0.08	6	0.006	0.009	0.009
			% Error	2%	3%	1%	5%	18%	15%
ISO_50%_B0_1	2/24/09	12:46:15	54%	4.85	0.91	576	0.097	0.033	0.045
ISO_50%_B0_2	2/25/09	14:33:30	57%	4.82	0.93	569	0.084	0.049	0.024
			Average	4.84	0.92	573	0.091	0.041	0.035
			Stdev or Range	0.02	0.01	3	0.006	0.008	0.010
			% Error	0%	1%	1%	7%	19%	30%
ISO_25%_B0_1	2/24/09	13:03:30	27%	5.1	0.52	557	0.055	0.016	0.034
ISO_25%_B0_2	2/25/09	14:47:45	25%	5.3	0.57	563	0.056	0.017	0.035
			Average	5.2	0.54	560	0.055	0.016	0.035
			Stdev or Range	0.1	0.02	3	0.000	0.001	0.001
			% Error	2%	4%	1%	0%	4%	2%
Idle_B0_1	2/24/09	13:33:30	6%	n/a	n/a	n/a	0.237	0.109	0.075
Idle_B0_2	2/25/09	15:02:30	6%	6.2	1.17	588	0.191	0.098	0.072
			Average	6.2	1.17	588	0.214	0.103	0.073
			Stdev or Range	n/a	n/a	n/a	0.023	0.006	0.002
			% Error	n/a	n/a	n/a	11%	6%	2%