

# Evaluating Emission Benefits of a Hybrid Tug Boat

**Final Report  
October 2010**

**Prepared for:**

**Mr. Todd Sterling**  
California Air Resources Board  
1001 I Street, Sacramento, CA 95814

Contract #07-413 and #07-419



**Authors:**

**Ms. Varalakshmi Jayaram**  
**Mr. M. Yusuf Khan**  
**Dr. J. Wayne Miller**  
**Mr. William A Welch**  
**Dr. Kent Johnson**  
**Dr. David R Cocker**

University of California, Riverside  
College of Engineering-Center for Environmental Research and Technology  
Riverside, CA 92521

## **Disclaimer**

This report was prepared as the result of work sponsored by the California Air Resources Board (CARB) and carried out with Foss Maritime Company. As such the report does not necessarily represent the views of CARB and Foss Maritime Company. Further the collective participants, its employees, contractors and subcontractors make no warrant, express or implied, and assume no legal liability for the information in this report; nor does any party represent that the uses of this information will not infringe upon privately owned rights. This report has neither been approved nor disapproved by the collective group of participants nor have they passed upon the accuracy or adequacy of the information in this report.

## Acknowledgements

The authors would like to thank *California Air Resources Board* for their financial support without which this project would not have been possible.

A special thanks to the following people for their time, effort and knowledge that helped in the smooth progress of this project:

### *Foss Maritime Company*

- Susan Hayman and Elizabeth Boyd at the Seattle Office for coordinating and closely following the progress of the project
- Long Beach port engineers Jerry Allen, Jim Russell, Steve Harris and several crews on the conventional and hybrid tugs for their logistical support during data acquisition and emissions testing on the tugs.
- Steve Hamil at the Seattle office for help with networking and setting up remote access to the data acquisition system on the tugs.

### *Aspin Kemp & Associates*

- Chris Wright, Paul Jamer and others for providing signals from the batteries on the hybrid boat and lengthy discussions on the operation and behavior of the batteries.

### *California Air Resources Board, El Monte*

- Edward Sun and Wayne McMahon for imparting their technical know-how on testing hybrid and plug in vehicles.

*Technical Working Group* with members from California Air Resources Board, Foss Maritime Company, Pacific Merchant Shipping Association, Ports of Los Angeles and Long Beach, South Coast Air Quality Management District and U.S. Environmental Protection Agency

- For overseeing the progress of the project

### *Startcrest Consulting LLC*

- Galen Hon for his help in planning and installing the data acquisition system on the tugs
- Bruce Anderson and Mark Carlock for their inputs on development of the test protocol

### *Independent Contractors*

- Mac MacClanahan for developing a circuit board with relays to collect data from the batteries on the hybrid boat.

*College of Engineering-Center of Environmental Research and Technology (CE-CERT), University of California Riverside*

- Charles Bufalino's for his efforts in the emission test preparation
- Kurt Bumiller for his help in developing the emissions data acquisition system

- Kathalena Cocker, Poornima Dixit, James Theodore Gutierrez, Sindhuja Ranganathan, Letia Solomon, David Torres and Charles Wardle of the analytical laboratory for preparation and analysis of filter sample media.
- Alex Vu for his help in developing Python 2.6 code to analyze activity data and plot GPS data.
- Ed Sponsler for setting up a File Transfer Protocol (FTP) site to transfer data from the tugs to CE-CERT.

# Table of Contents

<b>Disclaimer</b> .....	<b>ii</b>
<b>Acknowledgements</b> .....	<b>iii</b>
<b>Table of Contents</b> .....	<b>v</b>
<b>List of Figures</b> .....	<b>vii</b>
<b>List of Tables</b> .....	<b>ix</b>
<b>Executive Summary</b> .....	<b>x</b>
<b>1 Introduction</b> .....	<b>1</b>
1.1 Project Objectives .....	2
<b>2 Test Protocol and Test Plan</b> .....	<b>3</b>
2.1 Overview .....	3
2.2 Approach .....	3
2.3 Test Boats.....	4
2.4 Test Schedule .....	7
2.5 Determining Tug Boat Activity.....	8
2.5.1 Tug Operating Modes .....	8
2.5.2 Data Logging Procedure .....	10
2.5.3 Establishing Weighing Factors for Tug Operating Modes .....	17
2.5.4 Developing Engine Histograms .....	19
2.5.5 Calculating the Average Load Required for a Tug Operating Mode.....	23
2.6 Emissions Testing Procedure .....	23
2.6.1 Test Engines.....	23
2.6.2 Fuels.....	25
2.6.3 Test Cycle and Operating Conditions .....	26
2.6.4 Sampling Ports .....	28
2.6.5 Measuring Gases and PM <sub>2.5</sub> emissions .....	30
2.6.6 Calculating Exhaust Flow Rates .....	30
2.6.7 Calculation of Engine Load .....	31
2.6.8 Calculation of Emissions in g/hr.....	31
2.6.9 Calculation of Emission Factors in g/kW-hr .....	31
<b>3 Results and Discussions</b> .....	<b>33</b>
3.1 Activity.....	33
3.1.1 Weighing Factors for Tug Operating Modes .....	33
3.1.2 Engine Histograms for Conventional Tug .....	36
3.1.3 Engine Histograms for Hybrid Tug .....	38
3.1.4 Engine Histograms for Hybrid Tug without Batteries .....	42
3.2 Emissions Testing .....	45
3.2.1 Test Fuel Properties .....	45
3.2.2 Emissions Testing Phase 1 .....	45
3.2.3 Emissions Testing Phase 2.....	51
3.2.4 Carbon Balance.....	57
3.3 Total In-Use Emissions .....	58
<b>4 Summary and Recommendations</b> .....	<b>64</b>
<b>References</b> .....	<b>66</b>

<b>Appendix A - Measuring Gaseous &amp; Particulate Emissions.....</b>	<b>A-1</b>
A.1 Scope.....	A-2
A.2 Sampling System for Measuring Gaseous and Particulate Emissions.....	A-2
A.3 Dilution Air System.....	A-3
A.4 Calculating the Dilution Ratio.....	A-5
A.5 Dilution System Integrity Check.....	A-5
A.6 Measuring the Gaseous Emissions: CO, CO <sub>2</sub> , HC, NO <sub>x</sub> , O <sub>2</sub> , SO <sub>2</sub> ....	A-5
A.6.1 Measuring Gaseous Emissions: ISO & IMO Criteria.....	A-5
A.6.2 Measuring Gaseous Emissions: UCR Design.....	A-6
A.7 Measuring the Particulate Matter (PM) Emissions.....	A-8
A.7.1 Added Comments about UCR’s Measurement of PM.....	A-8
A.8 Measuring Real-Time Particulate Matter (PM) Emissions-DustTrak... .....	A-9
A.9 Quality Control/Quality Assurance (QC/QA).....	A-10
 <b>Appendix B - Test Cycles and Fuels for Different Engine Applications.....</b>	 <b>B-1</b>
B.1 Introduction.....	B-2
B.1.1 Intermediate speed.....	B-2
B.2 Engine Torque Curves and Test Cycles.....	B-3
B.3 Modes and Weighting Factors for Test Cycles.....	B-3
 <b>Appendix C - Tug Boat Specifications .....</b>	 <b>C-1</b>
C.1 Conventional Tug.....	C-2
C.2 Hybrid Tug.....	C-3
 <b>Appendix D – Engine Specifications from Manufacturers .....</b>	 <b>D-1</b>
D.1 Main Engine on Conventional Tug.....	D-2
D.2 Auxiliary Engine on Conventional Tug.....	D-8
D.3 Main Engine on Hybrid Tug.....	D-10
D.4 Auxiliary Engine on Hybrid Tug.....	D-13
 <b>Appendix E – Fuel Analysis Results.....</b>	 <b>E-1</b>

## List of Figures

Figure ES- 1 Overall In-Use Emissions based on Individual Tug Operating Mode Weighing Factors .....	xi
Figure 2-1 Diesel Electric Drive Train on the Hybrid Tug.....	6
Figure 2-2 Schematic of Data Logging System on the Conventional Tug .....	13
Figure 2-3 Schematic of the Data Logging System on the Hybrid Tug .....	14
Figure 2-4 Data-Logger, USB-1608FS and Relays on the Hybrid Tug .....	15
Figure 2-5 USB2-4COM-M - Receives serial signals from four engines and transmits them through one USB port to the data-logger .....	15
Figure 2-6 Dearborn Protocol Adapter .....	16
Figure 2-7 Wheelhouse on the Hybrid Tug shows Wheelhouse Switch in Orange Rectangle.....	16
Figure 2-8 ECM Load versus CO <sub>2</sub> Emissions for the Conventional Tug Main Engine CAT 3512 C .....	20
Figure 2-9 ECM Load versus CO <sub>2</sub> Emissions for the Conventional Tug Auxiliary Engine JD 6081 AFM75 .....	20
Figure 2-10 ECM Load versus CO <sub>2</sub> Emissions for the Hybrid Tug Main Engine Cummins QSK50-M .....	21
Figure 2-11 ECM Load versus CO <sub>2</sub> Emissions for the Hybrid Tug Auxiliary Engine Cummins QSM11-M.....	21
Figure 2-12 Correlation between Engine Load and Engine Speed for the Conventional Tug Main Engine CAT 3512 C .....	22
Figure 2-13 Auxiliary Engine on Conventional Tug JD 6085.....	24
Figure 2-14 Main Engine on Hybrid Tug Cummins QSK50-M.....	25
Figure 2-15 Auxiliary Engine on Hybrid Tug QSM11-M.....	25
Figure 2-16 Schematic of Test Setup for Phase 2 Emissions Testing .....	28
Figure 2-17 Sampling Port for Main Engine on Hybrid Tug.....	29
Figure 2-18 Sampling Port for Auxiliary Engine of Hybrid Tug .....	29
Figure 3-1 Overall Weighing Factors for Tug Operating Modes .....	33
Figure 3-2 Dock Locations in the Port of Los Angeles and Long Beach .....	35
Figure 3-3 GPS data of a typical day for the Conventional Tug .....	35
Figure 3-4 Main Engine Histograms for Conventional Tug.....	37
Figure 3-5 Engine Histogram for Hybrid Tug-1.....	38
Figure 3-6 Engine Histograms for the Hybrid Tug-2 .....	40
Figure 3-7 Engine Histograms for the Hybrid Tug-3 .....	41
Figure 3-8 Engine Histograms for Hybrid Tug without Batteries - 1 .....	42
Figure 3-9 Engine Histograms the Hybrid Tug without Batteries -2.....	43
Figure 3-10 Engine Histograms for the Hybrid Tug without Batteries -3.....	44
Figure 3-11 Emission Factors for Main Engine on Conventional Tug CAT 3512C .....	48
Figure 3-12 Emission Factors for Auxiliary Engine on Conventional Tug JD 6081 .....	48
Figure 3-13 Emission Factors for Main Engine on Hybrid Tug Cummins QSK50-M ....	49
Figure 3-14 Emission Factors for Auxiliary Engine on Hybrid Tug QSM11-M .....	49
Figure 3-15 PM <sub>2.5</sub> Mass Balance for A)Main Engine Conventional Tug CAT 3512 C B)Auxiliary Engine Conventional Tug JD 6081 C) Main Engine Hybrid	

Tug Cummins QSK50-M D) Auxiliary Engine Hybrid Tug Cummins QSM11-M .....	50
Figure 3-16 Comparison of Phases 1 & 2 for Main Engine on Conventional Tug CAT 3512 C .....	53
Figure 3-17 Comparison of Phases 1 & 2 for Main Engine of Hybrid Tug Cummins QSK50-M .....	54
Figure 3-18 Comparison of Phases 1 & 2 for Auxiliary Engine on Hybrid Tug Cummins QSM11-M .....	55
Figure 3-19 Emissions Profile for Main Engine on Conventional Tug CAT 3512 C .....	56
Figure 3-20 Emissions Profile of Main Engine on Hybrid Tug QSK50-M.....	56
Figure 3-21 Emissions Profile of Auxiliary Engine on Hybrid Tug Cummins QSK11-M .....	57
Figure 3-22 Carbon Balance for Test Engines.....	58
Figure 3-23 Overall Emission Reductions.....	61
Figure 3-24 Overall Emission Reductions for Retrofit Scenario 1.....	62
Figure 3-25 Overall Emission Reductions for Retrofit Scenario 2.....	63
Figure A-1 Partial Flow Dilution System with Single Venturi, Concentration Measurement and Fractional Sampling .....	A-3
Figure A-2 Field Processing Unit for Purifying Dilution Air in Carrying Case.....	A-3
Figure A-3 Setup Showing Gas Analyzer with Computer for Continuous Data Logging ... .....	A-6
Figure A-4 Picture of TSI DustTrak .....	A-9
Figure B-1 Torque as a Function of Engine Speed.....	B-3
Figure B-2 Examples of Power Scales.....	B-3



## List of Tables

Table 2-1 Engine Specifications for Conventional Tug .....	5
Table 2-2 Engine Specifications for Hybrid Tug.....	5
Table 2-1 Data Logging Test Schedule .....	7
Table 2-2 Test Schedule for Emissions Testing Phases 1 and 2.....	8
Table 2-3 Operating Details for Conventional Tug .....	9
Table 2-4 Operating Details for Hybrid Tug .....	9
Table 2-5 Details of Data-Logger .....	12
Table 2-8 Engine Specifications for Conventional Tug .....	24
Table 2-9 Engine Specifications for Hybrid Tug.....	24
Table 2-8 Test Matrix for Emissions Testing Phase 1 .....	27
Table 2-9 Test Matrix for Emissions Testing Phase 2 .....	27
Table 3-1 Weekly Variation in Operating Mode Weighing Factors for Conventional Tug .....	34
Table 3-2 Weekly Variation in Operating Mode Weighing Factors for Hybrid Tug .....	34
Table 3-3 Selected Fuel Properties .....	45
Table 3-4 Results for Phase 1 of Emissions Testing in g/hr .....	46
Table 3-5 Emission Factors in g/kW-hr from Phase 1 of Testing .....	47
Table 3-6 Results of Phase 2 of Emissions Testing.....	52
Table 3-7 Average Load Requirements for Each Operating Mode .....	58
Table 3-8 Emission Factors for Shore Power <sup>17, 18</sup> .....	59
Table 3-9 Modal and Overall Emission Reductions with Hybrid Technology .....	61
Table 3-10 Modal and Overall Emissions Reductions with Hybrid Technology for Retrofit Scenario 1 .....	62
Table 3-11 Modal and Overall Emissions Reductions with Hybrid Technology for Retrofit Scenario 2 .....	63
Table A-1 Components of a Sampling System: ISO/IMO Criteria & UCR Design .....	A-4
Table A-2 Detector Method and Concentration Ranges for Monitor .....	A-7
Table A-3 Quality Specifications for the Horiba PG-250 .....	A-7
Table A-4 Measuring Particulate by ISO and UCR Methods.....	A-8
Table B-1 Definitions Used Throughout ISO 8178-4.....	B-2
Table B-2 Combined Table of Modes and Weighing Factors .....	B-4

## Executive Summary

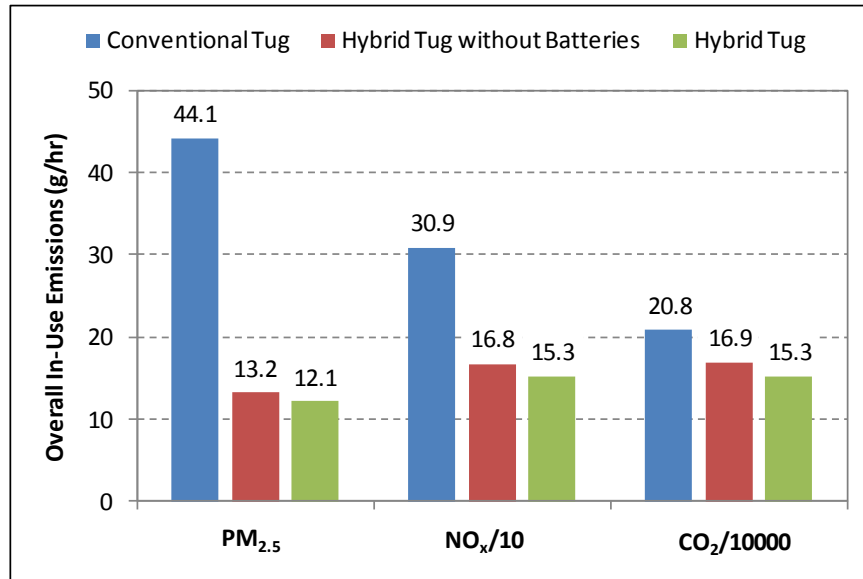
**Background:** Modern mobile sources are expected to simultaneously reduce criteria pollutants and greenhouse gas emissions to address the issues of air quality and global warming. One prevalent technology solution to achieve this goal is the use of two or more propulsion sources commonly known as the hybrid technology. Calculating the emissions benefits of a hybrid technology is quite challenging. The common thread in developing new test protocols is to ensure that energy used from multiple sources is properly analyzed. The goal of this research was to develop and implement a new test protocol that quantifies the benefits of using hybrid technology for a tugboat. For this purpose a side by side comparison of two “dolphin class” tugs, one conventional and the other hybrid, operating in the Ports of Los Angeles and Long Beach was performed. The conventional tug was powered by four diesel engines while the hybrid tug operated on four diesel engines and 126 batteries. All engines met United States Environmental Protection Agency’s Tier 2 certification.

**Methods:** This research project was conducted in three stages. The first stage involved development of a data-logging system capable of simultaneously monitoring and reporting the status of the power sources on each tug. This system was installed for a period of one month on each tug. Gigabytes of data were analyzed to determine the weighing factors, i.e., the fraction of time spent by the tug in the six discrete operating modes shore power, dock, transit, ship assist and barge move. Further engine histograms for all eight engines at these operating modes were established. A small sample of activity data (~1.5 days) was collected on the hybrid tug operating without batteries to quantify the effects of the diesel electric drive train versus batteries on the total emission reductions. The second stage of the research was a two-phase emissions testing program that focused on establishing an emissions profiles of the diesel engines. Emissions of criteria pollutants – nitrogen oxide, carbon monoxide, particulate matter and greenhouse gas carbon dioxide were measured based on the ISO 8178 protocols. The final stage of the research involved combining the activity and emissions data to calculate the overall in-use emissions from each tug and the emission reductions with the hybrid technology.

**Results:** The individual weighing factors at each operating mode for both tugs were found to be in good agreement. The average weighing factors for these operating modes were found to be 0.54 for dock plus shore power, 0.07 for standby, 0.17 for transit, 0.17 for ship assist and 0.05 for barge move. The conventional tug did not plug into shore power while the hybrid tug spent one-third of the time at dock plugged into shore power. During this program the batteries were not charged by shore power.

Detailed engine histograms for all eight engines at each operating mode are presented in the body of the report. The average operating loads as a percentage of the maximum power rating of the engines were found to be: 16% and 12% for the main and auxiliary engine on the conventional tug. 12% and 34% for the main and auxiliary on the hybrid tug. Detailed emissions profile data for one auxiliary and one main engine on each tug were obtained. Results are provided in Section 3.2.3 of the report.

Figure ES-1 shows the overall in-use emissions for each tug based on the individual operating mode weighing factors. Emission reductions with the hybrid technology were found to be 73% for PM<sub>2.5</sub>, 51% for NO<sub>x</sub> and 27% for CO<sub>2</sub>. The fuel equivalent CO<sub>2</sub> reductions were within 5% of the fuel savings reported by the tug owner over an eight month period. The diesel electric drive train on the hybrid tug that allows the use of auxiliary power for propulsion was the primary cause for the overall in-use emission reductions as opposed to the batteries. The transit operating mode was the most significant contributor to the overall emission reductions. A couple of retrofit scenarios for hybridization of existing tugs were modeled.



**Figure ES- 1** Overall In-Use Emissions based on Individual Tug Operating Mode Weighing Factors

**Conclusions:**

- An activity based model was developed to estimate the overall in-use emission reductions of a hybrid tug boat.
- Tug boats are a good application for the hybrid technology. Significant emission reductions were observed: 73% for PM<sub>2.5</sub>, 51% for NO<sub>x</sub> and 27% for CO<sub>2</sub>.
- The average operating load of the engines on both tugs are well below the load factors specified in the standard ISO duty cycles. The finding indicates need for the development of in-use duty cycle that would increase the accuracy of emission inventories.
- The hybrid system increased the average operating load on the auxiliary engine from 12% to 34%. However, the average load on the main engines was found to be only 12% of the maximum rating. These engines are still operating in inefficient zone suggesting the need for a larger energy storage system and smaller main engines in the next generation of hybrid tugs.
- Further improvements will result when the plug-in version is operative.

# 1 Introduction

The last decade has seen an increasing interest in the emissions from marine sources. Several studies<sup>1-6</sup> have shown that emissions from ports significantly affect the air quality in the populated areas around them. The sources in the ports include ships, harbor-craft, cargo-handling equipment, trucks and locomotives. Ships are the largest contributors to the total port emissions. Emissions from harbor-craft, though smaller, still form a significant part of the total port emissions<sup>7, 8</sup>. Harbor crafts include ferries, excursion boats, tugboats, towboats, crew and supply vessels, work boats, fishing boats, barges and dredge vessels.

Corbett's study<sup>9</sup> on waterborne commerce vessels in the United States revealed that in several states ~65% of the marine nitrogen oxide comes from vessels operating in inland waterways. Since, harbor craft (e.g., barges and tow-boats) are the most common commercial vessels operating in inland waterways<sup>10</sup> they could have significant effects on the air quality of inland areas as well.

Harbor-craft are typically powered by marine compression ignition engines which are regulated by United States Environmental Protection Agency's (U.S. EPA) code of federal regulation title 40 parts 85-94<sup>11</sup>. Emission studies<sup>12, 13</sup> on these vessels have predominately focused on older engines operating on high sulfur fuels. Current EPA emissions for these new marine engines require the use of low sulfur (<500ppm S) diesel or ultra-low sulfur diesel (ULSD) (<15ppm S).

Future regulations are geared towards simultaneous reduction of toxic air contaminants, criteria pollutants and green-house gas emissions to address the issues of air quality and global warming. One prevalent technology solution to achieve this goal is the use of two or more propulsion sources also known as the hybrid technology. A common application of this technology today is passenger cars.

This technology is not new to the marine world. Diesel electric submarines have been prevalent for over sixty years. The propeller (usually single) on these submarines is driven by an electric motor which derives energy from diesel generators or batteries. The diesel generators were also used to charge batteries.

Calculating the emissions benefits of a hybrid technology is quite challenging as they operate quite differently from the conventional technology. Test protocols developed for conventional systems have to be adapted appropriately based on the application. The common thread in developing new test protocols is to ensure that energy used from multiple sources is properly analyzed. The goal of this research was to develop and implement a new test protocol that quantifies the benefits of using hybrid technology for a tugboat.

## 1.1 Project Objectives

The primary goal of this project is to develop and implement a test protocol that establishes the emission reduction potential of the hybrid technology on a tug boat. Listed below are the different steps involved in achieving this goal

- Determine the activity of the tug boat by establishing typical operating modes, weighing factors and engine histograms for each of these modes.
- Measure gaseous and particulate matter (PM<sub>2.5</sub>) emissions from the main and auxiliary engines on the tug boats to
  - Verify if the engines meet the EPA Tier 2 standard during their typical operation.
  - Determine the emissions profile of these engines that can be coupled with the activity data to calculate their total in-use emissions in g/hr.
- Combining the activity and emissions data to determine the difference between the total emissions from a hybrid and conventional tug boat.

## 2 Test Protocol and Test Plan

### 2.1 Overview

The primary goal of this project is to determine the emission benefits of using a hybrid system on a tug. For this purpose two tugs from Foss Maritime Company's fleet, the Alta June (conventional tug) and the Carolyn Dorothy (hybrid tug), were chosen. Both tugs are "dolphin class" vessels equipped with four EPA Tier 2 certified engines.

Listed below is a brief description of the procedure adopted to determine the in-use emission benefits of the hybrid tug.

- a) Engine, GPS and battery data were logged for a month from each tug. This data was analyzed to determine the activity of the tugs and engine histograms for each operating mode.
- b) In-use emission measurements were made on one main and one auxiliary engine on each tug. These engines were analyzed to determine the gaseous (CO, CO<sub>2</sub> and NO<sub>x</sub>) and particulate matter (PM<sub>2.5</sub>) emissions for each engine across that engine's entire operating range.
- c) Activity and engine histogram data coupled with the emissions data were used to determine the total in-use emissions in g/hr from each tug.
- d) These total in-use emissions were then used to calculate the reduction of the gaseous and particulate matter species with the hybrid technology.

A detailed description of the approach, test schedule, measurement and analyses techniques used to determine the emission reduction potential of the hybrid technology are provided below.

### 2.2 Approach

The emission benefits of a hybrid tug can be calculated as follows

$$\text{Emission Reduction \%} = \frac{TE_c - TE_h}{TE_c} \times 100 \quad \text{----- Equation 2-1}$$

where,

$TE_c$  total in-use emissions for conventional tug in g/hr

$TE_h$  total in-use emissions for hybrid tug in g/hr

The total in-use emissions of any gaseous or particulate matter species, is determined using the following equation:

$$TE = \sum_{i=1}^n [W_i \sum_{j=1}^m (E_{ij})] \quad \text{----- Equation 2-2}$$

where,

$TE$  total in-use emissions in g/hr

- $n$  total number of operating modes (Section 2.5.1)
- $m$  the total number of power sources on the tug (Section 2.3)
- $W_i$  weighting factor for  $i^{th}$  operating mode (See Equation 2-3)
- $E_{ij}$  total in-use emissions in g/hr from the  $j^{th}$  power source for the  $i^{th}$  operating mode (See Equation 2-4)

The weighing factors for each operating mode are calculated as follows:

$$W_i = \frac{t_i}{t_{total}} \quad \text{----- Equation 2-3}$$

where,

- $W_i$  weighing factor for the  $i^{th}$  operating mode
- $t_i$  time spent by the tug in the  $i^{th}$  operating mode
- $t_{total}$  total sample time for the tug

As mentioned earlier, tug boats typically have four engines, two for propulsion and two auxiliary generators. To determine the total in-use emissions from each of these engines/power sources the following equation can be used:

$$E_{ij} = \sum_{k=1}^p [W L_{ijk} E L_{jk}] \quad \text{----- Equation 2-4}$$

where,

- $E_{ij}$  total in-use emissions in g/hr from the  $j^{th}$  power source/engine for the  $i^{th}$  operating mode
- $p$  total number of operating modes for the  $j^{th}$  power source (marine diesel engine). there are twelve operating modes for the engine based on the percentage of maximum engine load: off, 0 to <10%, 10% to <20%, 20% to <30%, and so on until 90% to <100% and 100%.
- $W L_{ijk}$  fraction of time spent by the  $j^{th}$  power source/engine at its  $k^{th}$  operating mode during the  $i^{th}$  tug boat operating mode. This value can be obtained from the engine histograms
- $E L_{jk}$  emissions in g/hr for the  $j^{th}$  power source/engine at its  $k^{th}$  operating mode

While developing engine histograms for the hybrid tug it is important to ensure that the state of charge of the battery at the start and end time of each sample period chosen for the calculation of the engine histogram are the same. This would eliminate any biases in emissions resulting from operation of the auxiliary generators for charging the batteries. The protocol was adopted after reviewing the hybrid testing protocol adopted by the Society of Automotive Engineers<sup>14</sup> (SAE) and California Air Resources Board<sup>15</sup> (CARB) for testing hybrid electric vehicles.

### 2.3 Test Boats

The primary goal of this project is to determine the emissions benefits of using a hybrid technology on a tug boat. For this purpose two boats, Alta June (conventional) and Carolyn Dorothy (hybrid), belonging to Foss Maritime Company's fleet operating in the

Ports of Los Angeles and Long Beach were chosen. Both tugs were equipped with EPA Tier 2 certified marine diesel engines. Vessel information is provided in Appendix C. Details of power sources on these boats are described below.

The conventional tug is powered by two 1902 kW CAT 3512C main engines and two 195 kW John Deere 6081 auxiliary engines (Table 2-1). This tug has two propellers. Each main engine is connected through a mechanical drive shaft to one propeller. Therefore both main engines have to be operated for moving and maneuvering the boat. The auxiliary engines are used for hotelling, lighting, air conditioning and operating the winch motor.

**Table 2-1** Engine Specifications for Conventional Tug

	<b>Main Engine</b>	<b>Auxiliary Engine</b>
<i>Manufacturer /Model</i>	CAT 3512C	John Deere 6081 AFM75
<i>Manufacture Year</i>	2008	2008
<i>Technology</i>	4-Stroke Diesel	4-Stroke Diesel
<i>Max. Power Rating</i>	1902 kW	-
<i>Prime Power</i>	-	195 kW
<i>Rated Speed</i>	1800 rpm	1800 rpm
<i># of Cylinders</i>	12	6
<i>Total Displacement</i>	58.6 lit	8.1 lit

The hybrid tug is powered by two 1342 kW Cummins QSK50-M main engines and 317 kW Cummins QSM11-M auxiliary generators (Table 2-2). It also has 126 soft gel lead acid batteries for power storage that are separated into two arrays with 63 batteries each. Each array stores 170.1kW-hr of energy when fully charged.

**Table 2-2** Engine Specifications for Hybrid Tug

	<b>Main Engine</b>	<b>Auxiliary Engine</b>
<i>Manufacturer /Model</i>	Cummins QSK50-M	Cummins QSM11-M
<i>Manufacture Year</i>	2007	2007
<i>Technology</i>	4-Stroke Diesel	4-Stroke Diesel
<i>Max. Power Rating</i>	1342 kW	-
<i>Prime Power</i>	-	317 kWm
<i>Rated Speed</i>	1800 rpm	1800 rpm
<i># of Cylinders</i>	16	6
<i>Total Displacement</i>	50 lit	10.8 lit

Figure 2-1 shows the diesel electric drive train on the hybrid tug. As in the case of the conventional tug the main engines are linked mechanically to the propellers through a



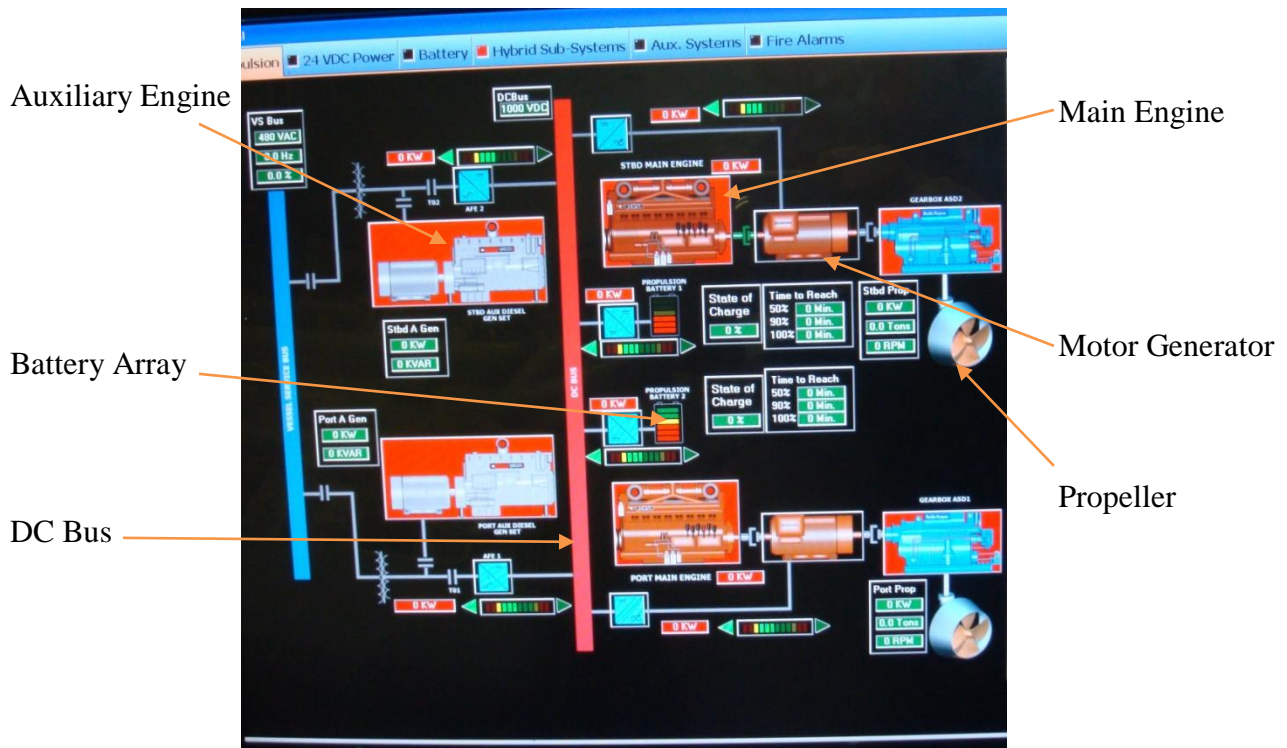
drive shaft. However, there is a motor-generator unit mounted on the shaft between each engine and propeller. This unit allows the electrical power from the batteries and auxiliary engines to drive the shaft for propelling the boat. Therefore the main engines on the hybrid tug have lower power rating than the ones on the conventional.

The motor generator also provides electrical power generated from the shaft using the main engines or freewheeling propeller (regenerative power) which is used for charging the batteries, driving the winch and other hotelling activities of the tug.

The batteries on the tug are predominately charged using the power from the auxiliary engines drawn through the DC bus. Since these auxiliary engines are used for charging batteries and propelling the boat, they have a higher power rating than those on the conventional tug.

The batteries have the capability of being charged by shore power. During this test program sufficient shore power was not available at the port to charge the batteries. As a result the batteries were always charged using the auxiliary engines.

The hybrid tug is equipped with an energy management system that manages the power sources and the drive train. The captain on the hybrid tug uses a switch in the wheelhouse to communicate the current operating mode of the tug to the energy management system. The signal from this wheelhouse switch helps the energy management system in making decisions regarding the number of power sources required to operate the tug. Further details of this wheelhouse switch are provided in Section 2.5.2.



**Figure 2-1** Diesel Electric Drive Train on the Hybrid Tug

## 2.4 Test Schedule

The testing program was conducted in over a seven month period from January to July 2010. The testing consists of two parts

- a) Data Logging for a one month period on each tug to determine tug activity
- b) Emissions testing of one main and one auxiliary engine on each tug.

Table 2-1 shows the data logging schedule for the conventional and the hybrid tugs. During data logging on the hybrid tug several problems were encountered with the data-logger and the tug boat. As a result data was obtained intermittently for five to sixteen day periods instead of one continuous one month period. In the final phase of data logging, the hybrid tug was operated for a period of 1.5 days (06/14/2010 09:00 to 06/15/2010 23:00), with the batteries disconnected from the diesel electric drive train. This was done to determine the effects of the drive train versus the batteries on the overall emission reductions. Details of the data logging procedure and analysis to determine the tug activity are provided in Section 2.5.

**Table 2-3** Data Logging Test Schedule

<b>Tug Boat</b>	<b>Start Time</b>	<b>End Time</b>
<i>Conventional</i>	1/8/2010 17:04:41	2/12/2010 13:10:22
	3/4/2010 17:24:32	3/21/2010 4:59:58
	3/26/2010 14:45:40	4/2/2010 10:30:53
<i>Hybrid</i>	4/30/2010 8:19:46	5/11/2010 11:53:23
	5/19/2010 9:52:13	5/24/2010 8:14:29
	6/8/2010 10:02:04	6/17/2010 12:22:25

Emissions testing of one main and one auxiliary engine on each tug were performed in two phases. A brief description of these phases is provided below. Further details on emissions testing and analysis are presented in Section 2.6.

*Phase 1* involved in-use gaseous and PM<sub>2.5</sub> emissions measurements based on the ISO 8178-1 protocol following the load points in the standard certification cycle. The main propulsion engines were tested based on the ISO 8178-4 E3 cycle and the auxiliary engines were tested following the ISO 8178-4 D2 cycle.

*Phase 2* of emissions testing involved determining an emissions profile of the main engines on both tugs and the auxiliary engine on the hybrid tug. For this purpose gaseous and real time PM<sub>2.5</sub> emissions were measured across several load points spanning the entire operating range of the engines.

Phase 1 was performed during the initial stages of data logging on each tug while Phase 2 was conducted at the end of the test program. Table 2-2 shows the emissions test schedule.

**Table 2-4** Test Schedule for Emissions Testing Phases 1 and 2

<b>Phase</b>	<b>Tug Boat</b>	<b>Engine</b>	<b>Date</b>	<b>Start Time</b>	<b>End Time</b>
<b>1</b>	<i>Conventional</i>	JD 6081	01/14/10	09:00	17:30
		CAT 3512C	01/15/10	08:30	17:30
	<i>Hybrid</i>	Cummins QSM11-M	03/03/10	09:00	17:00
		Cummins QSK50-M	03/04/10	09:00	17:30
<b>2</b>	<i>Conventional</i>	CAT 3512 C	07/08/10	10:00	16:30
	<i>Hybrid</i>	Cummins QSM11-M	06/08/10	11:00	13:45
		Cummins QSK50-M	06/08/10	13:45	17:30

## **2.5 Determining Tug Boat Activity**

The following sections describe the typical operating modes of the tug boat, procedure for data collection and analysis to establish the weighing factors for each operating mode as well as development of engine histograms for all four engines on each tug.

### **2.5.1 Tug Operating Modes**

After several conversations with port engineers and executives from the tug company the modes of operation of a typical tug were determined. These are provided below:

*Shore Power:* The tug is at the dock plugged into shore power for its utilities. None of the engines are operating during this mode. The hybrid boat spends considerable amount of time plugged into shore power while the conventional tug hardly plugs in.

*Dock:* During this operation the tug boat is at the dock with one auxiliary engine operating for powering the lights and air-conditioning on the boat. On the conventional tug one auxiliary engine is on at dock. The hybrid tug switches between one auxiliary engine and batteries during this mode. If the state of charge (SOC) of the battery arrays reduce to 60% one of the auxiliary engines turn on to charge the batteries and provide hotelling power for the tug. As soon as the batteries are charged to a SOC of 80% the engine turns off and the batteries discharge providing hotelling power.

*Standby:* In this mode the tug is idling in the water waiting for a call from the pilot or dispatch to start or transit to a job. The conventional tug operates two main propulsion engines and one auxiliary generator during standby. As in the case of dock the hybrid tug switches between the batteries and one auxiliary engine.

*Transit:* This mode refers to the movement of the tug between jobs and to and from different docks. The conventional tug boat operates two main engines and one auxiliary engine during transit. The hybrid boat switched between batteries and one auxiliary engines for transit at slow speed <6.0 knots within the port. For higher speeds the hybrid tug operates two auxiliary generators.

*Ship Assist and Barge Moves* Tug boats typically perform two kinds of jobs in the ports – a) assisting ships from berth to sea and vice-versa b) moving barges from one location to another. Each of these jobs is treated as a separate operating mode as the total work done for ship assist and barge move are considerably different. The conventional tug operates two main engines and one auxiliary engine during this mode. The hybrid boat operates all four engines for a job. Also one battery array is on the charging mode and the other is in the discharge mode.

Tables 2-3 and 2-4 show the operating details for the conventional and hybrid tug boats during each mode

**Table 2-5** Operating Details for Conventional Tug

<b>Operational Modes</b>	<b>ME #1 CAT 3512</b>	<b>ME #2 CAT 3512</b>	<b>AE #1 JD 6081</b>	<b>AE#2 JD 6081</b>
<i>Shore Power</i>	Off	Off	Off	Off
<i>Dock</i>	Off	Off	On	Off
<i>Standby</i>	On	On	On	Off
<i>Transit</i>	On	On	On	Off
<i>Barge Move</i>	On	On	On	Off
<i>Ship Assist</i>	On	On	On	Off

*ME: Main Engine, AE: Auxiliary Engine*

**Table 2-6** Operating Details for Hybrid Tug

<b>Operational Modes</b>	<b>ME #1 Cummins QSK50-M</b>	<b>ME #2 Cummins QSK50-M</b>	<b>AE #1 Cummins QSM11-M</b>	<b>AE#2 Cummins QSM11-M</b>	<b>Battery</b>
<i>Shore Power</i>	Off	Off	Off	Off	Off
<i>Dock</i>	Off	Off	On	Off	On
<i>Standby</i>	Off	Off	On	Off	On
<i>Transit</i>	Off	Off	On	Off	On
<i>Fast Transit</i>	Off	Off	On	On	On
<i>Barge Move</i>	On	On	On	On	On
<i>Ship Assist</i>	On	On	On	On	On

*ME: Main Engine, AE: Auxiliary Engine*

## 2.5.2 Data Logging Procedure

To determine the activity of the conventional and hybrid tug GPS, engine and battery data had to be logged continuously for a period of one month from each tug. For this purpose, a Labview program was developed that was capable of interfacing with four engine electronic control modules (ECMs), a GPS and batteries to retrieve the required information continuously on a second by second basis and write it into a comma separated value (CSV) file. Each line in the CSV file generated by the code represents one second. The program automatically creates a new file after 65500 seconds thereby ensuring that the CSV file is not too large for Microsoft Excel to handle. This Labview program was installed and operated on the data-logger which is a standard laptop with Windows XP operating system. Table 2-7 lists all the parameters that were logged from the two tugs along with the devices used for interfacing between the power sources and the data-logger.

Schematics of the data-logger set up on the conventional and hybrid boats are provided in Figures 2-2 and 2-3. The data-logger was placed on the workbench in the engine room of each tug boat. Data from the ECMs on the two main propulsion engines and the two auxiliary engines were obtained using four Dearborn Protocol Adapters that convert the J1939 signals to serial/RS-232 signals. Power for the Dearborn adapters was obtained from the batteries used for engine startup.

A Garmin GPS that provides data on location, speed and course of the tug at any second during the sample time was placed at the top of the mast on the tug boat to ensure that it receives a clear signal. Serial cables were run from GPS to the data-logger.

An event-logger developed by Starcrest Consulting LLC, was installed in the wheelhouse of the conventional tug. This event-logger is a circular switch that provides a distinct analog voltage signal for each position that it is on. These switch positions were used to indicate the operating modes as follows,

- Position 1 - 3.0 volts - Dock
- Position 2 - 4.5 volts - Standby
- Position 3 - 6.0 volts - Slow Transit, speed < 6.0 knots (speed limit in the port)
- Position 4 - 7.5 volts - Fast Transit, speed > 6.0 knots
- Position 5 - 9.0 volts - Assist

The Captains on the tug were provided with instructions on operating the event-logger switch. The analog signal from the event-logger was transmitted through shielded cables to the data-logger in the engine room.

The hybrid tug is operated differently from the conventional tug. It has a switch in the wheelhouse that used by the captains for operating the boat. This wheelhouse switch communicates with an energy management system to determine how many power sources will be required for that operation. The wheelhouse switch has four positions which indicate the mode of operation of the tug. These are listed below:

- 1 - Dock      Tug switches between the batteries and one auxiliary engine.
- 2 - Standby    Tug switches between the batteries and one auxiliary engine.

- 3 - Transit Tug uses one or two auxiliary engines along with batteries depending on the load requirement.
- 4 - Assist Tug uses all four engine and the batteries for a job.

Aspin Kemp and Associates provided us with five digital signals, four from the wheelhouse switch and one indicating if the boat was plugged into shore power or not. They also provided us with six analog signals that give information on the operation of the two battery arrays

- 1 - State of Charge of Array A
- 2 - State of Charge of Array B
- 3 - Voltage of Array A
- 4 - Voltage of Array B
- 5 - Current for Array A
- 6 - Current for Array B

Remote access was made available by Foss Maritime Company using Virtual Network Computing (VNC) server and client application. UCR was able to log onto the data-logger on a daily basis to ensure that the system was operating properly. The wireless network on the boat was not strong enough for file transfer. Therefore the port engineer uploaded the CSV files and scanned copies of the tug's paper logs on a weekly basis to a file transfer protocol (FTP) site.

**Table 2-7** Details of Data-Logger

	<b>CT</b>	<b>HT</b>	<b>Devices Used</b>	<b>Parameters Logged</b>
GPS	√	√	<ul style="list-style-type: none"> <li>• Garmin GPS 18 PC receives wireless signal from satellite and transmits it through a serial port to the data-logger</li> </ul>	Date, time, latitude, longitude, speed and course
Two main propulsion engines and two auxiliary engines	√	√	<ul style="list-style-type: none"> <li>• 4 Dearborn Protocol Adapters Model DG-DPAIII/i that receive J1939 signal from engine electronic control modules (ECM)</li> <li>• 4 Dearborn Protocol Adapter cables (DG-J1939-04-CABLE) that convert the J1939 signal to serial/RS232 signal,</li> <li>• One USB2-4COM-M that receives 4 serial signals and transmits them through one USB port to the data-logger</li> </ul>	Engine speed (rpm), engine load (percentage of maximum load at the engine speed), instantaneous fuel flow rate (cc/min), inlet manifold temperature (°F) and pressure (kPa)
Event-Logger	√	×	<ul style="list-style-type: none"> <li>• Omega’s USB-1608FS box that receives five analog from the event-logger located in the wheelhouse and transmits them through a single USB cable to the data-logger</li> </ul>	Operating modes: dock, standby, slow transit, fast transit and assist
Wheelhouse Switch	×	√	<ul style="list-style-type: none"> <li>• 5 Philmore 86-124 (24 vDC, 10 A) SPDT relays convert the signals from wheelhouse switch to digital voltage signals.</li> <li>• Omega’s USB-1608FS box receives these five digital signals from the relays and transmits them through a single USB cable to the data-logger.</li> </ul>	Operating Modes: shore power, dock, standby, transit and assist
Battery Arrays	×	√	<ul style="list-style-type: none"> <li>• Omega’s USB-1608FS box that receives six analog signals from the battery arrays and transmits them through a single USB cable to the data-logger.</li> </ul>	State of charge, voltage in volts and current in amps for each battery array.

*CT: Conventional Tug, HT: Hybrid Tug*

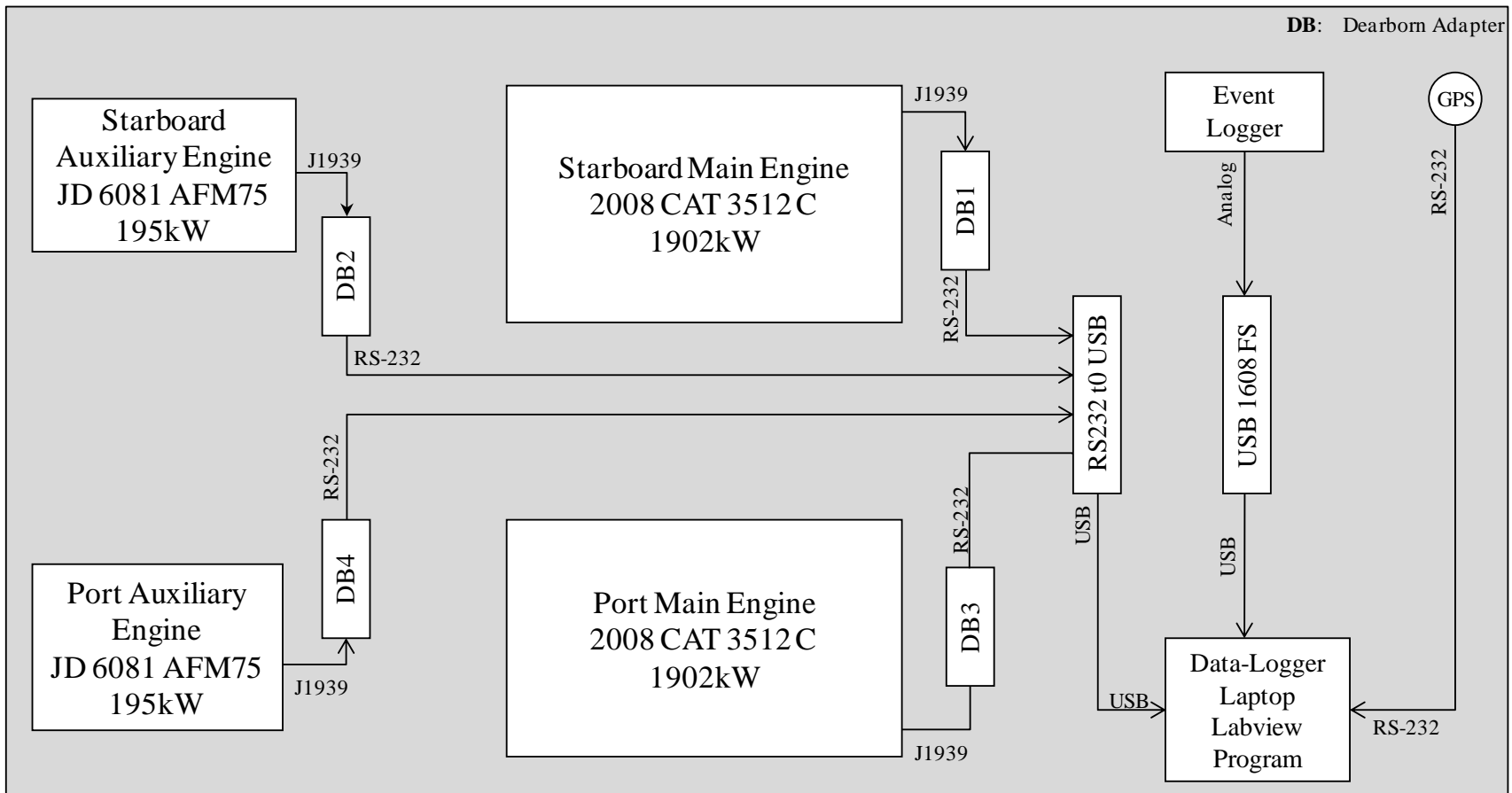
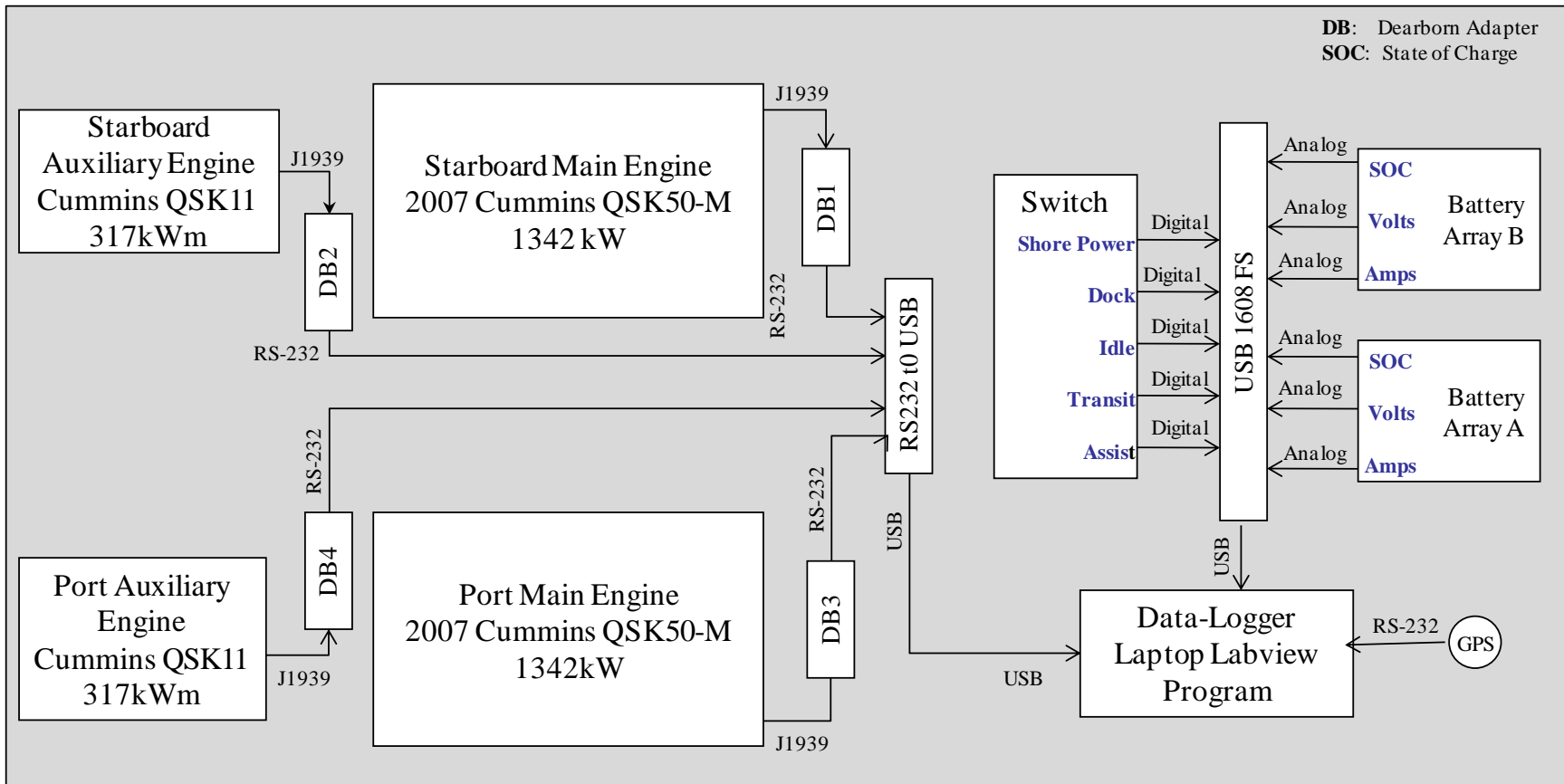


Figure 2-2 Schematic of Data Logging System on the Conventional Tug





**Figure 2-3** Schematic of the Data Logging System on the Hybrid Tug



**Figure 2-4** Data-Logger, USB-1608FS and Relays on the Hybrid Tug



**Figure 2-5** USB2-4COM-M - Receives serial signals from four engines and transmits them through one USB port to the data-logger



**Figure 2-6** Dearborn Protocol Adapter



**Figure 2-7** Wheelhouse on the Hybrid Tug shows Wheelhouse Switch in Orange Rectangle

### 2.5.3 Establishing Weighing Factors for Tug Operating Modes

The weighing factor for each operating mode was calculated as the ratio of the time spent by the tug in that mode to the total sample time (Equation 2-3). The CSV files obtained from the data-logger have a field called “opmode” that contained a unique number/code for each tug operating mode based on the data obtained from the event-logger switch for the conventional tug and the wheelhouse switch for the hybrid tug.

During the analysis several discrepancies were seen in the data obtained from the switches on both tugs. These had to be rectified before calculating the weighing factors. Details of these corrections are provided below.

*Conventional Tug:* On this tug, the human error involved in turning the event-logger switch made the signal from the event-logger unreliable. As a result data from the boats paper logs, engines and GPS had to be analyzed to determine the operation mode. This was done as follows. The opmode field on each line in the CSV files contained a unique code to indicate the operating mode 1-Ship Assist, 2-Barge Move, 3-Shore Power, 4-Dock, 5-Standby and 6-Transit. Here is how the operating modes were determined.

- The boat’s paper logs provide accurate start time, end time and route for ship assists and barge moves. So based on these logs the codes 1 or 2 were manually entered into opmode field of the CSV files
- At times when the tug was not performing a ship assist or barge move the following filters were used
  - When all four engines are off the tug is plugged into shore power
  - When both main engines are off tug is at the dock
  - If the GPS speed is greater than 0.0 knots and both main engines are on, the tug is in transit
  - If the GPS speed is 0.0 knots and at least one main engines is on, the tug is in standby

*Hybrid Tug:* As in the case of the conventional tug the wheelhouse switch on the hybrid tug was not accurate. Listed below are some instances which resulted in inaccuracy:

- Typically the tug is switched to transit mode 2-5 minutes before the beginning of transit. These few minutes belong to the standby mode.
- When the time between two transits is less than fifteen minutes the tug is operated in transit mode instead of switching back and forth between standby and transit.
- When the time between two jobs is small (<20 minutes) the tug transits from one job to the next on the assist mode.
- In the event the tug has to rush to get to a job, the tug is operated on the assist mode. This provides extra power for fast transit.
- Some captains switch to assist mode 5-15 minutes before the job begins. So the tug could be in the last part of its transit to the job or on standby when the switch is on assist mode.

- The captain may decide to transit in the assist mode for safety purposes like heavy fog.

As a result the data from the hybrid tug also had to be analyzed in conjunction with the GPS data and boat paper logs to determine the operating modes accurately. Listed below are details of the analysis

- The original CSV files had the following codes for the opmode field 1-Shore Power, 2-Dock, 3-Standby, 4-Transit, 5-Assist. These were modified and additional tags were incorporated to account for different scenarios as follows:
  - 1-Shore Power
  - 2-Dock with one engine or batteries
  - 3-Standby with one engine or batteries
  - 4-Transit with one engine or batteries
  - 5-Ship Assist
  - 6-Transit with more than one engine on
  - 7-Barge Move
  - 8-Standby with more than one engine on
  - 9-Standby at dock with more than one engine on
- The signal for shore power was accurate and did not have to be modified in any way.
- Using the boat's paper logs and the GPS data the start and end time for ship assists and barge moves were corrected manually in the CSV files. The codes 5 and 7 were entered for ship assist and barge move respectively.
- When the boat was at dock and more than one engine was operating the code 2 was replaced by 9 to indicate standby at dock with more than one engine on.
- At all other times, (when the tug was not performing an job, was not plugged into shore power and was not at dock) the following filters were used
  - If the GPS speed was zero the boat was in standby. The engine ECM data was checked to determine which code to use
    - 3-standby with one engine or batteries
    - 8-standby with more than one engine on
  - If the GPS speed was greater than zero the boat was in transit. Again, the engine ECM data was used to determine the code
    - 4-transit with one engine or batteries
    - 6-transit with more than one engine on

After correcting the opmode field in all the CSV files a Python 2.6 code was written to read all these files and calculate the total time spent in each operating mode. Using this information the weighing factors were calculated for each tug boat.

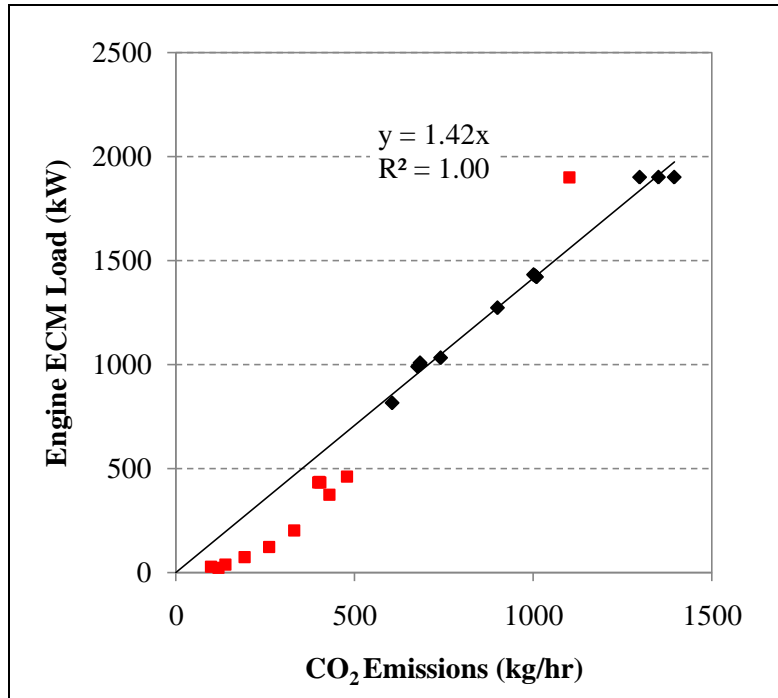
## 2.5.4 Developing Engine Histograms

Engine histograms are basically graphs showing the amount of time the engine spends at different loads. In this project engine histograms have to be developed for all four engines on each tug for each tug operating mode. During the data logging procedure the engine speed in rpm and engine load as a percentage of the maximum load at that speed were retrieved from the engines' ECMs and written into the CSV files. For the auxiliary engines which are constant speed diesel generators, the percent load from the ECM has to be multiplied by the maximum rated load of the engine in kW to get the load on the engine. The main propulsion engines are variable speed engines. Therefore, at any given speed the maximum attainable load in kW was obtained from the engines' lug curve and multiplied by the percent load retrieved from the ECM to determine the load on the engine. Lug curves for these main engines (CAT 3512 C, Cummins QSK50-M) were obtained from the respective engine manufacturer (Appendix D).

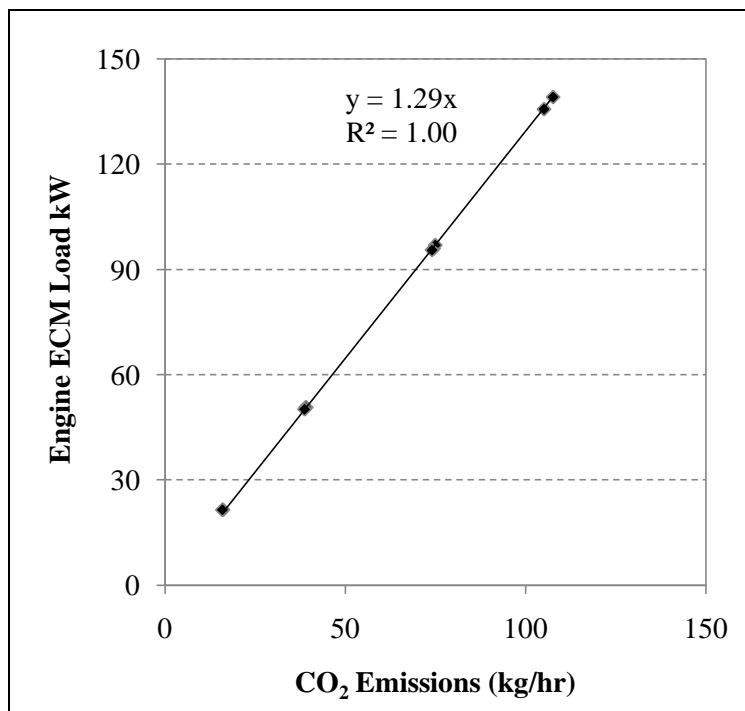
Engine ECMs do not actually measure the load on the engine; they use an algorithm to estimate the load. This algorithm is proprietary and varies from one engine manufacturer to another. Typically engine ECMs provide an accurate load estimate at high engine loads and deviate from the true value at low loads. This is true particularly for off-road and marine engines where ECMs are not regulated.

The ratio of the carbon-dioxide emissions to the load on the engine is an indication of its thermal efficiency. This efficiency tends to be relatively constant across the entire range of engine operation. Therefore we would expect a straight line relationship between the engine load and the CO<sub>2</sub> emissions in g/hr. Any significant deviation from the straight line relationship will indicate an error in the load readings provided by the ECM. Figures 2-8, 2-9, 2-10 and 2-11 show plots of engine ECM load versus the measured CO<sub>2</sub> emissions in kg/hr for one auxiliary and one main engine on each tug. A good straight line correlation is observed for all but the main engine on the conventional tug (CAT 3512 C). For this engine we see that the load drops off from the straight line around the 25% engine load. Therefore a load correction has to be applied to this engine alone.

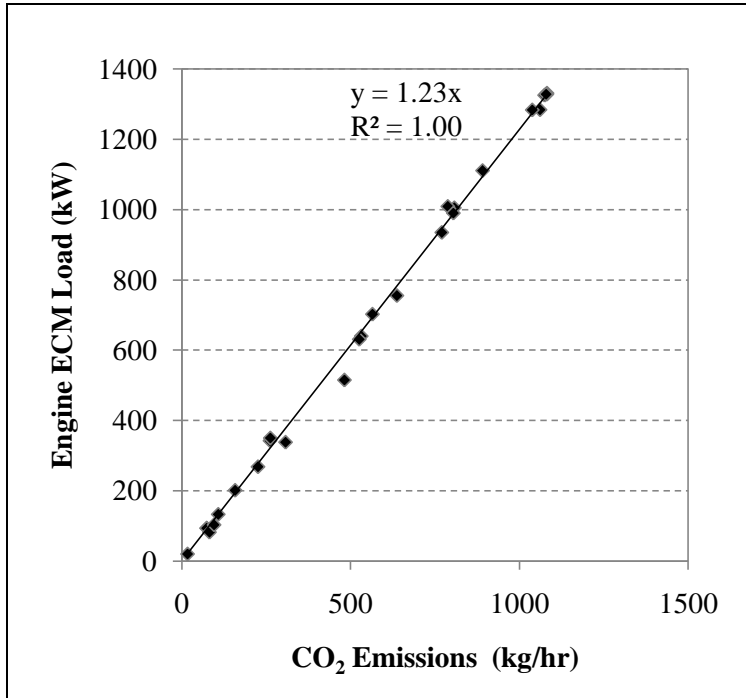
The data-logger used on the conventional tug collected engine speed and percent maximum load from the engine ECM. It does not collect a real-time CO<sub>2</sub> emissions data. Therefore the equation for the straight line fit to the ECM load versus CO<sub>2</sub> cannot be used to correct this data. Instead the load has to be presented as a function of the engine speed. Figure 2-12 shows the correlation between the CO<sub>2</sub> corrected engine load and engine speed for the CAT 3512 C engine. This correlation was used to calculate the load for speeds below 1300rpm, for all higher speed the percent load obtained from the ECM was used for the calculation.



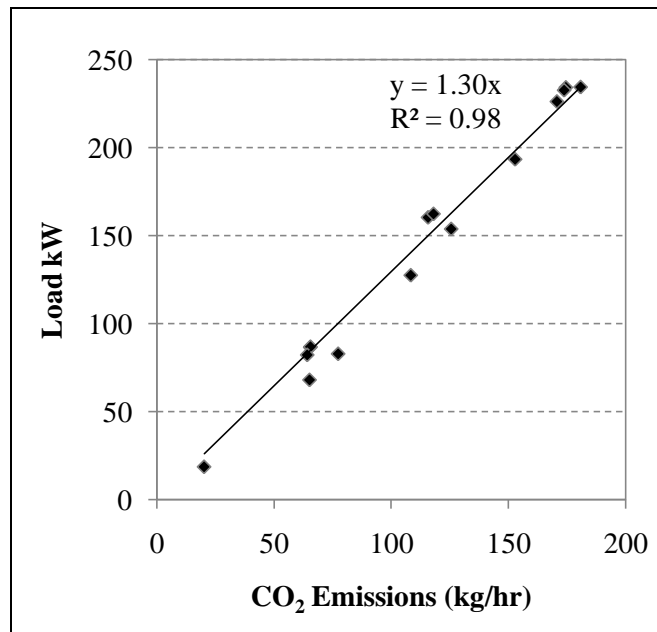
**Figure 2-8** ECM Load versus CO<sub>2</sub> Emissions for the Conventional Tug Main Engine CAT 3512 C



**Figure 2-9** ECM Load versus CO<sub>2</sub> Emissions for the Conventional Tug Auxiliary Engine JD 6081 AFM75

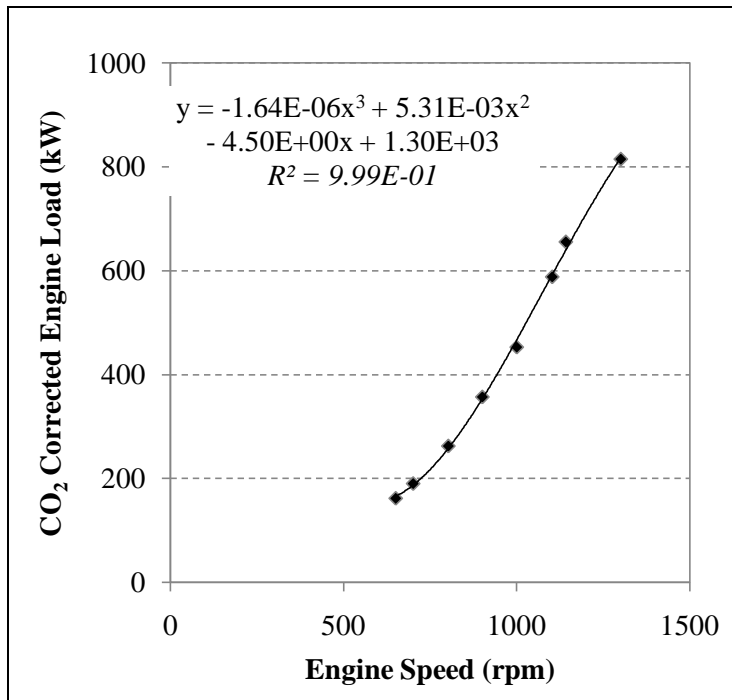


**Figure 2-10** ECM Load versus CO<sub>2</sub> Emissions for the Hybrid Tug Main Engine Cummins QSK50-M



**Figure 2-11** ECM Load versus CO<sub>2</sub> Emissions for the Hybrid Tug Auxiliary Engine Cummins QSM11-M





**Figure 2-12** Correlation between Engine Load and Engine Speed for the Conventional Tug Main Engine CAT 3512 C

Microsoft Excel was used for the calculation of the engine loads. Four extra fields were added in the CSV files for the calculated loads of the main and the auxiliary engines. Engine loads were then split into twelve bins:

Bin Off	Engine is Off
Bin 1	0 to <10%
Bin 2	10% to <20%
Bin 3	20% to <30%
Bin 4	30% to <40%
Bin 5	40% to <50%
Bin 6	50% to <60%
Bin 7	60% to <70%
Bin 8	70% to <80%
Bin 9	80% to <90%
Bin 10	90% to <100%
Bin 11	100%

Four more fields were added to indicate the bin in which the main and auxiliary engines were operating. A Python 2.6 code was written to calculate the total time spent by the engine in each bin for each operating mode. Using this data the fraction of time spent by the engine in any bin for a particular operating mode was calculated. This was then plotted in the form of engine histograms.

The engine histograms developed from the CSV files are used to calculate the total emissions from a tug. Therefore it is important to ensure that the state of charge of the

battery at the start and end time of each sample period chosen for the calculation of the engine histogram are the same. This would eliminate any biases in emissions resulting from the use of the auxiliary engine for charging the batteries. This protocol was adopted based on the guidelines in the SAE<sup>14</sup> and CARB<sup>15</sup> testing protocols for hybrid electric vehicles.

### 2.5.5 Calculating the Average Load Required for a Tug Operating Mode

For the conventional tug, the total energy used in kW-sec for each operating mode during the data logging period was obtained by summing up the kW on all four engines for every second of time spent in that mode. This value was then divided by the total time spent in that operating mode to get the average load needed to perform that operation.

On the hybrid tug, the energy from the batteries also had to be taken into account. The following formula was used to calculate the energy in kW-sec drawn from each battery array.

$$E_{battery} = (SOC_{start} - SOC_{end}) \times 170.1 \times 3600 \quad \text{—————Equation 2-5}$$

where,

$E_{battery}$	energy drawn from or into the battery array
$SOC_{start}$	state of charge of the array at the start of the chosen sample time
$SOC_{end}$	state of charge of the array at the end of the chosen sample time
170.1	the total energy content of the battery array in kW-hr
3600	number of seconds in an hour

To determine the average load required to for any particular operating mode, the total energy drawn from all four engines and two battery arrays for that operation was divided by the total time spent in that operating mode.

## 2.6 Emissions Testing Procedure

As mentioned in Section 2.4 emissions testing were performed in two phases. Phase 1 focused on determining how well the test engines meet the EPA Tier 2 standard when in-use, while Phase 2 was aimed at determining an emissions profile for each engine across its entire operating range. A brief description of the test engines, fuels, test cycle, operating conditions, experimental setup, measurement methods and emissions calculations are provided in this section.

### 2.6.1 Test Engines

Each tug had two main engines and two auxiliary engines. On the conventional tug the two main engines were exactly the same make and model and manufactured in the same year. In fact these engines had consecutive serial numbers. This was true of the main engines on the hybrid as well as the auxiliary engines on both the tugs. Based on this information, it is reasonable to assume that the mains and auxiliaries on any tug will have the same emissions profile. Therefore, emissions testing were performed only one main and one auxiliary engine on each tug. Specifications of the engines are provided in Tables

2-8 and 2-9. Pictures of some of the test engines are provided in Figures 2-13, 2-14 and 2-15.

**Table 2-8** Engine Specifications for Conventional Tug

	<b>Main Engine</b>	<b>Auxiliary Engine</b>
<i>Manufacturer /Model</i>	CAT 3512C	John Deere 6081 AFM75
<i>Manufacture Year</i>	2008	2008
<i>Technology</i>	4-Stroke Diesel	4-Stroke Diesel
<i>Max. Power Rating</i>	1902 kW	-
<i>Prime Power</i>	-	195 kW
<i>Rated Speed</i>	1800 rpm	1800 rpm
<i># of Cylinders</i>	12	6
<i>Total Displacement</i>	58.6 lit	8.1 lit

**Table 2-9** Engine Specifications for Hybrid Tug

	<b>Main Engine</b>	<b>Auxiliary Engine</b>
<i>Manufacturer /Model</i>	Cummins QSK50-M	Cummins QSM11-M
<i>Manufacture Year</i>	2007	2007
<i>Technology</i>	4-Stroke Diesel	4-Stroke Diesel
<i>Max. Power Rating</i>	1342 kW	-
<i>Prime Power</i>	-	317 kWm
<i>Rated Speed</i>	1800 rpm	1800 rpm
<i># of Cylinders</i>	16	6
<i>Total Displacement</i>	50 lit	10.8 lit



**Figure 2-13** Auxiliary Engine on Conventional Tug JD 6085



**Figure 2-14** Main Engine on Hybrid Tug Cummins QSK50-M



**Figure 2-15** Auxiliary Engine on Hybrid Tug QSM11-M

## **2.6.2 Fuels**

All four engines were tested while operating on the normal fuel of operation, red dye ultra low sulfur diesel. A fuel sample was obtained from each tug and sent to an external

laboratory for analysis of selected properties. Details of the fuel analysis are provided in Table 3-3 in the results section.

### **2.6.3 Test Cycle and Operating Conditions**

*Phase 1:* The primary goal of this phase of the testing program was to establish if the test engines meet their certification standards when in-use. Gaseous and PM<sub>2.5</sub> emission measurements on these engines were made based on the ISO 8178-1 protocol (Appendix A). Briefly, a partial dilution system with a venturi was used for PM<sub>2.5</sub> sampling (Appendix A, Figure A-1). Carbon dioxide, nitrogen oxides and carbon monoxide were measured in both the raw and the dilute exhaust. The ratio of the concentration of carbon dioxide in the raw to the in the dilute was used to determine the dilution ratio for PM<sub>2.5</sub> sampling.

The main propulsion engines were tested following the steady state load points in the ISO 8178-4 E3 cycle. An additional measurement was made at the idle load. The auxiliary engines were operated at the steady state load points in the ISO 8178-4 D2 cycle. Details of the test cycles are provided in Appendix B.

The steady state load points on the main engine of the conventional tug and both engines on the hybrid tug were achieved while the tug pushed against the pier. The auxiliary engine on the hybrid tug could not be operated at loads higher than 75%. Also for loads <20% the engine would keep switching on and off due to the presence of the batteries. Hence these low loads could not be measured.

Since the auxiliary generator on the conventional tug is not used for propulsion and the typical steady state load on this engine is 12% of its maximum load, a load bank had to be used to achieve the higher load points. Even with the load bank this engine could not be operated steadily at loads higher than 75%. Therefore only four out of the five load points on the D2 cycle were achieved for emissions testing.

Due to practical considerations, the actual engine load at each test mode on all four engines could differ by a factor of  $\pm 5\%$  from the ISO target load. Table 2-8 lists the test matrix for Phase 1 of emissions testing.

At each steady state test mode the protocol requires the following:

- Allowing the gaseous emissions to stabilize before measurement at each test mode.
- Measuring gaseous and PM<sub>2.5</sub> concentrations for a time period long enough to get measurable filter mass
- Recording engine speed (rpm), displacement, boost pressure and intake manifold temperature in order to calculate the mass flow rate of the exhaust.

**Table 2-10** Test Matrix for Emissions Testing Phase 1

<b>Tug Boat</b>	<b>Engine</b>	<b>Date</b>	<b>Engine Loads</b>
<i>Conventional</i>	JD 6081	01/14/10	<i>RT &amp; ISO:</i> 75%,50%,25%, 10%
	CAT 3512C	01/15/10	<i>RT &amp; ISO:</i> 100%,75%,50%,25%, Idle
<i>Hybrid</i>	Cummins QSM11-M	03/03/10	<i>RT &amp; ISO:</i> 75%, 50%, 25%
	Cummins QSK50-M	03/04/10	<i>RT &amp; ISO:</i> 100%, 75%, 50%, 25%, Idle

*RT: Real Time Monitoring and Recording of Gaseous Emissions*

*ISO: Filter Samples taken in accordance with ISO 8178-4 E3/D2 cycles*

**Phase 2:** The goal of Phase 2 was to determine the emissions profile of the test engines over their entire operating range. The activity data showed that auxiliary engine on the conventional tug operates at a steady load of 12%, since this load point was already tested during Phase 1 this engine was not tested again. The other three test engines had a wider range of operating conditions. The loads on the auxiliary engine of the hybrid tug varied from idle to 75% of the prime power. The main engines on both tugs operated predominantly at the low loads and occasionally at loads as high as the maximum rated power. The test matrixes for all three engines were designed to incorporate the steady state load points already measured during Phase 1 along with several intermediate steady state loads (Table 2-9). This matrix will fill in some of the gaps between the ISO target loads and provide a better idea of the emission trends for each engine as a function of its load.

**Table 2-11** Test Matrix for Emissions Testing Phase 2

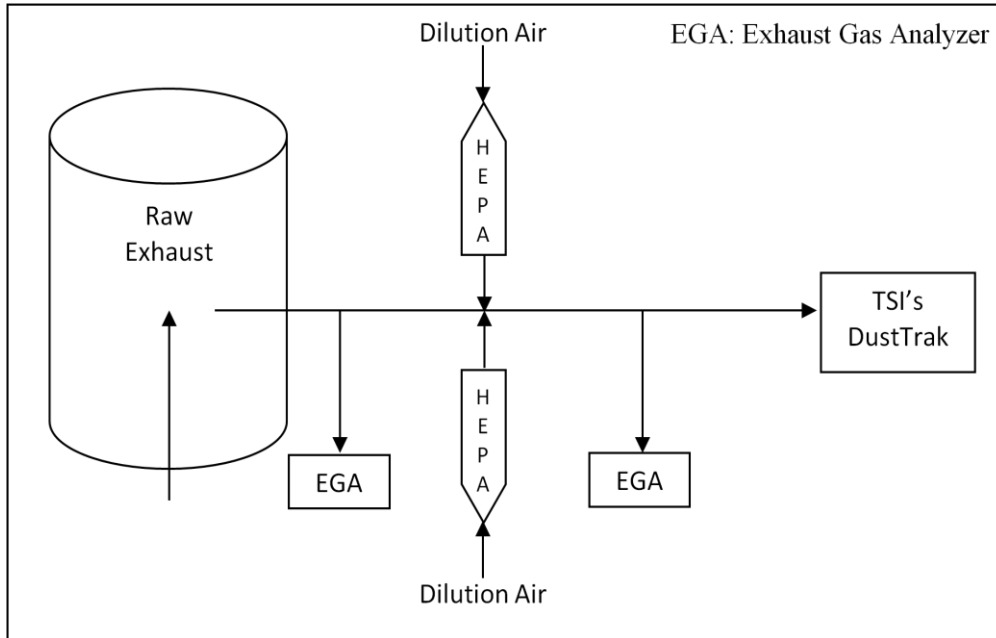
<b>Tug Boat</b>	<b>Engine</b>	<b>Date</b>	<b>Engine Speeds (rpm)/ Load (% max)</b>
<i>Conventional</i>	CAT 3512C	07/08/10	<i>RTP:</i> 1780, 1655, 1542, 1434, 1301, 1142, 1000, 900, 800, 700, Idle
<i>Hybrid</i>	Cummins QSM11-M	06/08/10	<i>RTP:</i> 75%, 60%, 50%, 40%, 25%, 20%
	Cummins QSK50-M	06/08/10	<i>RTP:</i> 1780, 1700, 1600, 1525, 1424, 1300, 1142, 1050, 950, 850, 750, Idle

*RTP: Real Time Monitoring and Recording of Gaseous and PM<sub>2.5</sub> Emission*

Gaseous measurements were made in accordance to the ISO 8178-1 protocols (Appendix A, Section A.6). A simple partial dilution system was used for measuring the real-time PM<sub>2.5</sub> emissions using TSI's DustTrak (Appendix A, Section A.8). Schematic of this test setup is shown in Figure 2-16. As in the case of Phase 1, gaseous measurements were made both in the raw and dilute exhaust. The ratio of the CO<sub>2</sub> concentrations in the raw versus the dilute was used to determine the dilution ratio for PM<sub>2.5</sub> measurements.

At each steady state test mode the following were done:

- Allowing the gaseous emissions to stabilize before measurement at each test mode.
- Measuring gaseous and  $PM_{2.5}$  concentrations for a total time of five minutes.
- Recording engine speed (rpm), displacement, boost pressure and intake manifold temperature in order to calculate the mass flow rate of the exhaust.

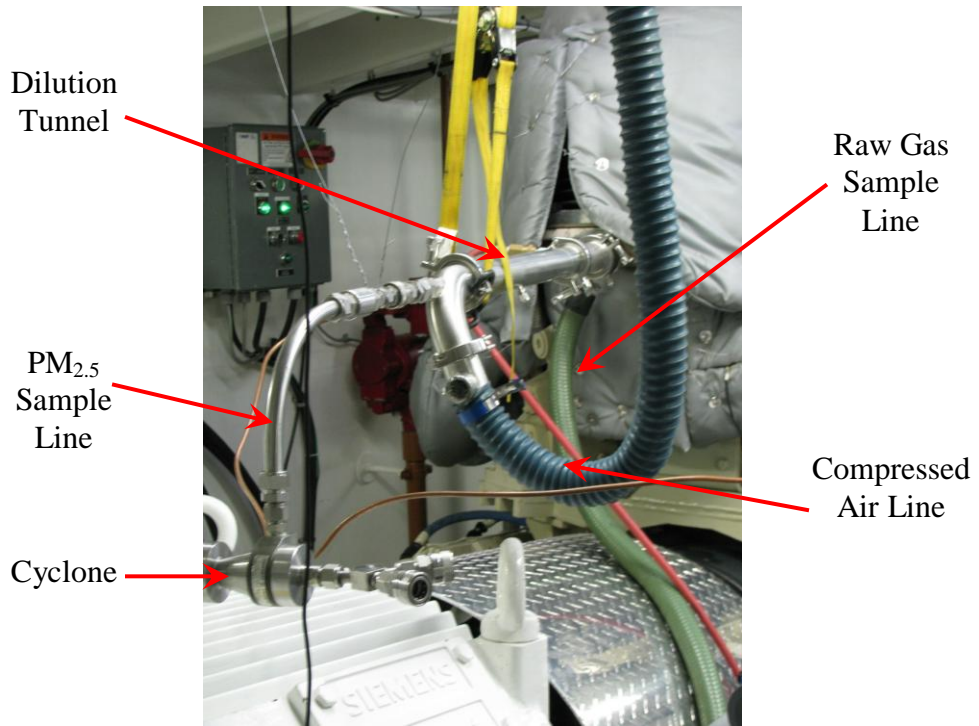


**Figure 2-16** Schematic of Test Setup for Phase 2 Emissions Testing

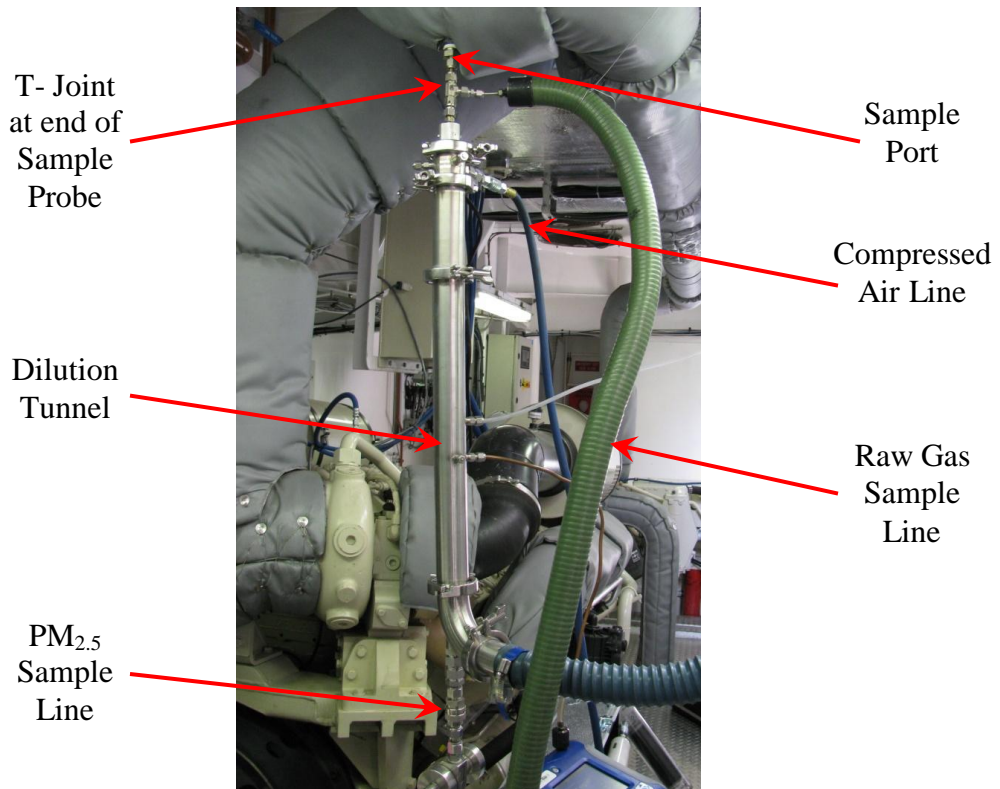
#### 2.6.4 Sampling Ports

Only one sample port was available in the stack of each engine. A T-joint was installed at the end of the sample probe to provide raw gas sample for gaseous measurements and dilution for  $PM_{2.5}$  sampling. Sample ports on both main and auxiliary engines were located before the muffler. For the main propulsion engines, the sample port was located just a few inches above the exhaust manifold while on the auxiliary engines it was several feet away from the manifold. The sampling probes used for emissions testing were  $3/8^{\text{th}}$  inch stainless steel tubing. These probes were inserted five inches into the main engine stacks (stack diameter: fourteen inches) and two inches into the auxiliary engine stack (stack diameter: six inches). These distances were sufficiently away from any effects found near the stack walls. Figure 2-17 and Figure 2-18 show pictures of the sampling ports main and auxiliary engines of the hybrid tug. The test setup was similar for the conventional tug.





**Figure 2-17** Sampling Port for Main Engine on Hybrid Tug



**Figure 2-18** Sampling Port for Auxiliary Engine of Hybrid Tug



### 2.6.5 Measuring Gases and PM<sub>2.5</sub> emissions

The concentrations of carbon dioxide (CO<sub>2</sub>), nitrogen oxide (NO<sub>x</sub>) and carbon monoxide (CO) were measured both in the raw exhaust and the dilution tunnel with a Horiba PG-250 portable multi-gas analyzer (Appendix A, Section A.6) During Phase 1 particulate matter (PM<sub>2.5</sub>) was sampled from the dilution tunnel on Teflo<sup>®</sup> and Tissuquartz filters. These filters were analyzed to determine the total and speciated PM<sub>2.5</sub> mass emissions (Appendix A, Section A.7). In Phase 2 of emissions testing TSI's DustTrak was used to provide real-time PM<sub>2.5</sub> mass concentrations (Appendix A, Section A.8). A continuously data acquisition system was used to log real time measurements of gaseous and PM<sub>2.5</sub> emissions and flows through the Teflo<sup>®</sup> and Tissuquartz filters.

### 2.6.6 Calculating Exhaust Flow Rates

**Intake Air Method:** An accurate calculation of the exhaust gas flow rate is essential for calculating emission factors. This method calculates the exhaust gas flow rate as equal to the flow of intake air. This method is widely used for calculating exhaust flow rates in diesel engines and assumes the engine is an air pump, so the flow of air into the engine will be equal to the exhaust flow out of the engine. The flow rate of intake air is determined from the cylinder volume, recorded engine speed, and the temperature and pressure of the inlet air. The method works best for four stroke engines or for two-stroke engines where there the scavenger air flow is much smaller than the combustion air. All four test engines in this program were four stroke marine diesel engines.

**Carbon Balance Method:** Clearly the calculated emission factor is strongly dependent on the mass flow of the exhaust. Two methods for calculating the exhaust gas mass flow and/or the combustion air consumption are described in ISO 8178-1<sup>16</sup>. Both methods are based on the measured exhaust gas concentrations and fuel consumption rate. The two ISO methods are described below.

*Method 1*, Carbon Balance, calculates the exhaust mass flow based on the measurement of fuel consumption and the exhaust gas concentrations with regard to the fuel characteristics (carbon balance method). The method is only valid for fuels without oxygen and nitrogen content, based on procedures used for EPA and ECE calculations.

*Method 2* Universal, Carbon/Oxygen-balance, is used for the calculation of the exhaust mass flow. This method can be used when the fuel consumption is measurable and the fuel composition and the concentration of the exhaust components are known. It is applicable for fuels containing H, C, S, O and N in known proportions.

The carbon balance methods may be used to calculate exhaust flow rate when the fuel consumption is measured and the concentrations of the exhaust components are known. In these methods, flow rate is determined by balancing carbon content in the fuel to the measured carbon dioxide in the exhaust. This method can only be used when the fuel consumption data are available.

For the auxiliary engine on the hybrid tug (Cummins QSK11-M) and main engines on both tugs (CAT 3512C, Cummins QSK50-M), intake manifold temperature and pressure readings were obtained from the engine ECM using the data-logger. These were used for the exhaust flow calculation based on the intake air method. The calculated exhaust flow

rates for these three engines were compared with the data provided by the engine manufacturer. The calculated flows for the main engines were found to be in reasonably good agreement while those of the auxiliary engine were off by a factor of 17 to 25%. Therefore, the exhaust flow measurements provided by the engine manufacturer were used for the Cummins QSK11-M engine alone.

The data-logger was unable to retrieve the intake manifold temperature and pressure data from the ECM of the auxiliary engine on conventional tug (JD 6081). It was however, able read instantaneous fuel flow data. Since, the engine manufacturer did not provide any data on exhaust flows, flow calculations were performed following the carbon balance method.

### 2.6.7 Calculation of Engine Load

The actual load on the engine at each test mode is required to calculate the modal and overall emission factors in g/kW-hr. The engine ECM provides engine speed and the percentage of the maximum engine load at that speed. For the main propulsion engines, this data was used along with the lug curve provided by the manufacturer for that engine family (Appendix D) to determine the actual load in kW for each test mode. The ECM on the main engine for the conventional tug deviated from the true value at loads below 25% of the maximum rated power. Therefore, at these low loads the true load on the engine was calculated based on the measured CO<sub>2</sub> emissions in g/hr using the correlation obtained in Figure 2-8. For the constant speed auxiliary engines the percentage of maximum engine load obtained from the engine ECM was multiplied by the engine's rated prime power to get the load on the engine in kW.

### 2.6.8 Calculation of Emissions in g/hr

Mass emissions of CO<sub>2</sub>, NO<sub>x</sub> and CO in g/hr were calculated using the calculated exhaust flows and the measured concentrations in the exhaust. For PM<sub>2.5</sub> mass emissions the concentration in the dilute exhaust was calculated as a ratio of the measured filter weight to the total sample flow through the filter. This was then converted to a concentration in the raw exhaust by multiplying with the dilution ratio. The raw PM<sub>2.5</sub> concentration was used along with the exhaust flow to determine the mass emissions in g/hr.

### 2.6.9 Calculation of Emission Factors in g/kW-hr

The emission factor at each mode is calculated as the ratio of the calculated mass flow (g/hr) in the exhaust to the reported engine load (kW).

An overall single emission factor representing the engine is determined by weighting the modal data according to the ISO 8178 E3 or ISO 8178 D2 cycle requirements and summing them. The equation used for the overall emission factor is as follows:

$$A_{WM} = \frac{\sum_{i=1}^n (g_i \times WF_i)}{\sum_{i=1}^n (P_i \times WF_i)} \quad \text{----- Equation 2-6}$$

where:

$A_{WM}$  overall weighted average emission factor in g/kW-hr  
 $n$  total number of modes in the ISO duty cycle  
 $g_i$  calculated mass flow in g/hr for the  $i^{th}$  operating mode  
 $WF_i$  weighing factor for the for the  $i^{th}$  operating mode  
 $P_i$  engine load in kW for the  $i^{th}$  operating mode

### 3 Results and Discussions

#### 3.1 Activity

##### 3.1.1 Weighing Factors for Tug Operating Modes

Figure 3-1 shows the overall weighting factors for the conventional and hybrid tug. Total sample times used for the determined these weighing factors were ~34 days for the conventional tug and ~48 days for the hybrid. The figure shows that the dolphin class tug spends about ~54% of its total operating time at dock (includes shore power), ~7% in standby, ~17% in transit, ~17% in ship assist and ~5% making barge moves. The tug company expected their boats to spend more than 7% of total time in standby and less at dock. After reviewing their written logs with the operations people and comparing it once again with the results from the data-logger, these numbers were confirmed to be accurate.

Results also show that the conventional tug hardly plugs into shore power. This tug does not always sail back to its home berth instead it docks as the closest berth until the next job. The hybrid tug on the other hand spends a little over a third of time at dock plugged into shore power at the home berth.

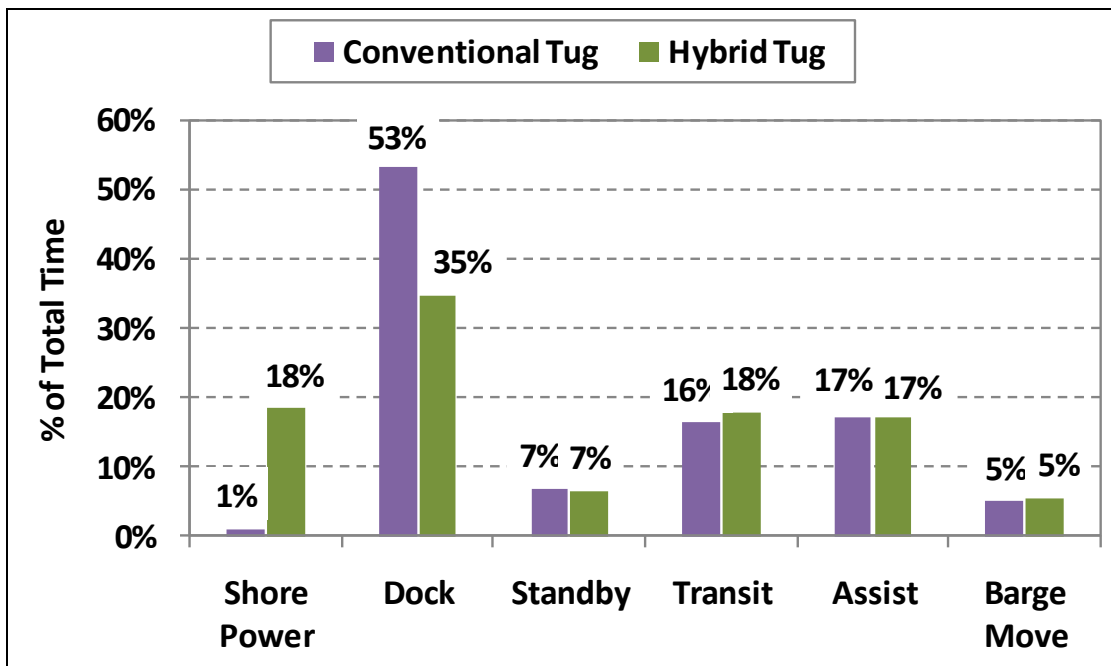


Figure 3-1 Overall Weighing Factors for Tug Operating Modes

The weighing factors for standby, assist and barge move were found to be identical for the two tugs. The only difference in the weighing factors between the tugs is found in the transit and dock positions. However a glance at the weekly variation in the weighing factors tabulated in Tables 3-1 and 3-2 show that this difference is an inherent part of the operation of the tugs and not a function of the type of tug (conventional versus hybrid). The weekly variation data also show that weighing facts don't change significantly from one week to another. This indicates that the average weighing factors over the one month

period are a good representation of the time spent by these tugs in the different operating modes.

**Table 3-1** Weekly Variation in Operating Mode Weighing Factors for Conventional Tug

<i>Sample Time (Days)</i>	<b>8.7</b>	<b>8.7</b>	<b>8.7</b>	<b>8.7</b>	<b>Average</b>
Shore Power + Dock	57%	54%	52%	55%	55% ± 2%
Standby	6%	7%	8%	6%	7% ± 1%
Transit	16%	15%	15%	19%	16% ± 2%
Barge Move	2%	3%	8%	7%	5% ± 3%
Assist	19%	20%	17%	13%	17% ± 3%

**Table 3-2** Weekly Variation in Operating Mode Weighing Factors for Hybrid Tug

<i>Sample Time(Days)</i>	<b>9.4</b>	<b>7.1</b>	<b>6.8</b>	<b>11.1</b>	<b>4.9</b>	<b>8.8</b>	<b>Average</b>
Shore Power	19%	23%	16%	14%	20%	20%	19% ± 3%
Dock	38%	32%	36%	38%	34%	28%	34% ± 4%
Standby	8%	6%	6%	6%	5%	7%	6% ± 1%
Transit	15%	18%	19%	18%	19%	19%	18% ± 1%
Barge Move	5%	5%	6%	6%	4%	6%	5% ± 1%
Ship Assist	15%	16%	15%	17%	19%	20%	17% ± 2%

Figure 3-2 is a GPS plot of all the dock locations (seen as blue dots) of the boat. The dock locations in the red rectangle represent the home pier for these tugs. The figure also shows some dock locations out in the open water many of which have a C-shaped pattern. Tugs move fuel barges to these locations to fuel large ocean going vessels. The ocean going vessels and the barges are anchored and the tugs tie up to the barge. While tied up they often float in a C-shaped pattern due to the ocean currents. The tugs also tie up at several other piers around the Ports of Los Angeles and Long Beach for short periods of time between two jobs. Figure 3-3 shows the GPS plot of a typical day which includes several ship assists, barge moves, transits, standby and docking periods.



**Figure 3-2** Dock Locations in the Port of Los Angeles and Long Beach  
*Note:* Blue dots represent dock locations. Home Berth is indicated by the red rectangle



**Figure 3-3** GPS data of a typical day for the Conventional Tug  
*Note:* Trace made by the blue dots indicates the route taken by the tug

### **3.1.2 Engine Histograms for Conventional Tug**

The conventional boat has only one of the two auxiliary engines working at all tug operating modes except shore power. This auxiliary engine always operated at 10-12% of its maximum load. Therefore an engine histogram of the auxiliary engine would show a 100% bar at the 10-12% load with no bars at all other load points.

The main engines on the conventional tug are off when the tug is at dock or plugged into shore power. During the standby mode these engines are idling with an engine load of about 5-7% of the maximum rated power. Figure 3-4 shows engine histograms for both main engines on the conventional tug for transit, barge move and ship assist operating modes. The average load required for a transit is 718kW, 608kW for ship assist and 754kW. During a ship assist typically two to three tugs help maneuver the ship to berth from sea or vice versa. The ship also has its propulsion engine on during an assist. So the average load required for the assist is minimal. A barge does not have a propulsion engine. It is moved from one place to another solely with the energy provided by the tug. Also most barge moves are done with a single tug. Therefore the average load required for a barge move is a lot larger than that for a ship assist.

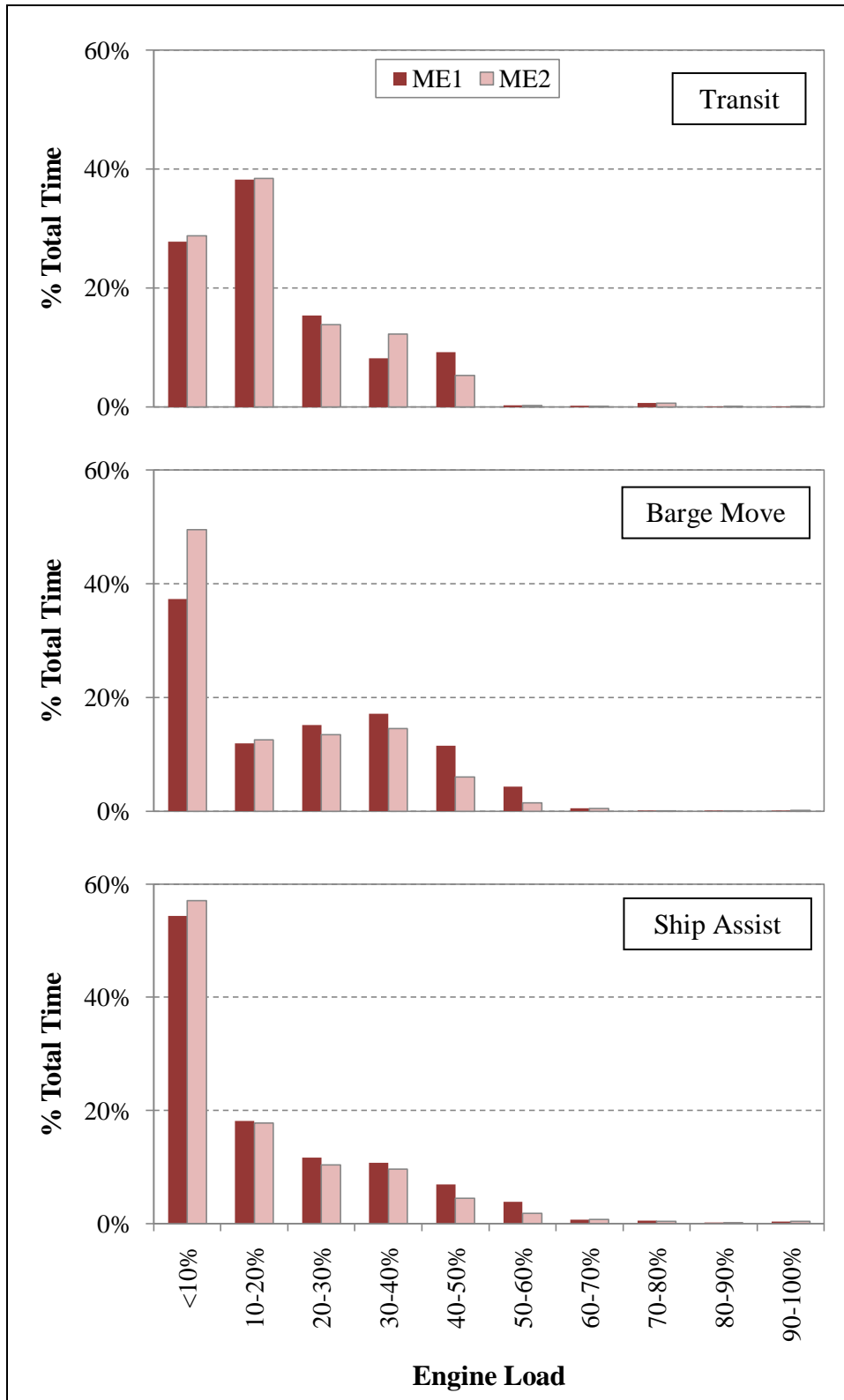


Figure 3-4 Main Engine Histograms for Conventional Tug



### 3.1.3 Engine Histograms for Hybrid Tug

Figures 3-5 through 3-7 show the engine histograms for the all four engines on the hybrid tug. While calculating these histograms, it was ensured that the state of charge of batteries at the start to the end of each period of sample time was the same. The total sample time used for the calculation of these histograms is ~41 days.

As in the case of the conventional tug, all four engines of the hybrid tug are off during shore power. The hybrid tug operates predominantly on one auxiliary engine and the batteries during dock, standby and slow transit modes. Figure 3-5 shows the histogram of the primary auxiliary engine when all other engines on the tug are off. It is observed that about 80% of the time spent in dock and 30% of the time spent in standby the tug operates on just battery power.

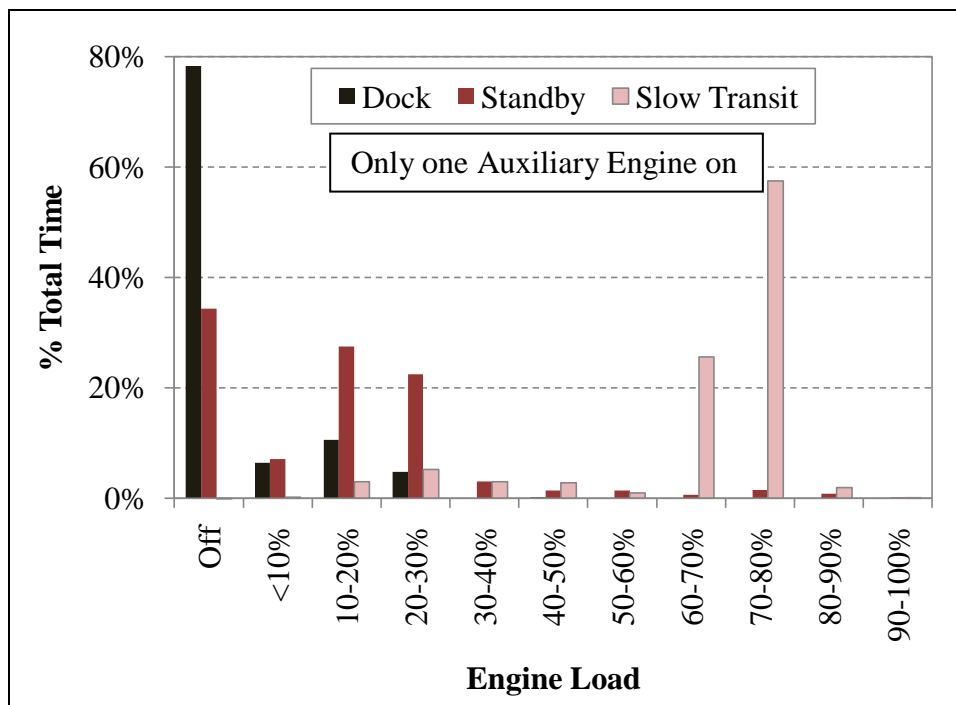


Figure 3-5 Engine Histogram for Hybrid Tug-1

The hybrid tug spends ~17% of its total time in standby and ~30% of its total time in transit with more than one auxiliary engine is on. Figure 3-6 shows engine histograms for these instances. As mentioned in Section 2.5.3 the wheelhouse switch on hybrid tug could be in the transit or ship assist mode when tug is actually on standby. This happens usually when the tug is getting ready or has just finished a job/transit. As a result we sometimes find two auxiliary engines or all four engines on during standby. To operate the tug at speeds greater than ~6.0 knots two auxiliary engines and batteries are needed. Therefore we find that during a significant portion of the transit mode both auxiliary engines are on. The main engines on the hybrid tug are generally operated only during a ship assist or barge move. The engine manufacturer recommends a five minute cool down period before shutting down these engines. During this cool down period these engines are idling at <10% load. The large bars in the 0-10% engine load bin of the main engine

histograms in Figure 3-6 represent these cool down periods. On some rare occasions these main engines are used for transit which is indicated by the bars seen at loads >10% in the main engine histograms, for transit with more than one engine on.

The average load required by the hybrid tug to transit was found to be 278kW. This is much lower than that required by the conventional tug (718kW) for the same job. The primary reason for this reduction is the use of the diesel electric drive train on the hybrid tug. On the conventional tug each propeller is connected to one main engine, therefore to transit both main engines have to be on and all the power for propulsion is derived from these two engines. Since these main engines have maximum power rating of 1902 kW, the sum of idling loads on these two engines is significant ~190 kW. On the hybrid tug, only one and sometimes two auxiliary engines along with the batteries are used for propulsion during transit. As a result we would expect a tremendous reduction in emissions and fuel savings in this operating mode.

Figure 3-7 shows engine histograms for all four engines during ship assists and barge moves. The average load required for a ship assist or a barge move using the hybrid tug was found to be 508 kW and 507 kW respectively. These loads are much lower than that required by the conventional tug 608 kW and 754 kW for the same jobs. One of the significant contributors to this difference is the idle load on the main engines. For the conventional tug idle load on the main engine is ~95 kW whereas for the hybrid tug it is ~67 kW. Since the main engines on both tugs spend about 50% to 75% of the total time during a ship assist/ barge move in this mode, the conventional tug has a higher average power for the same jobs. On the hybrid tug we don't see a significant difference in the average loads required for a barge move and a ship assist.

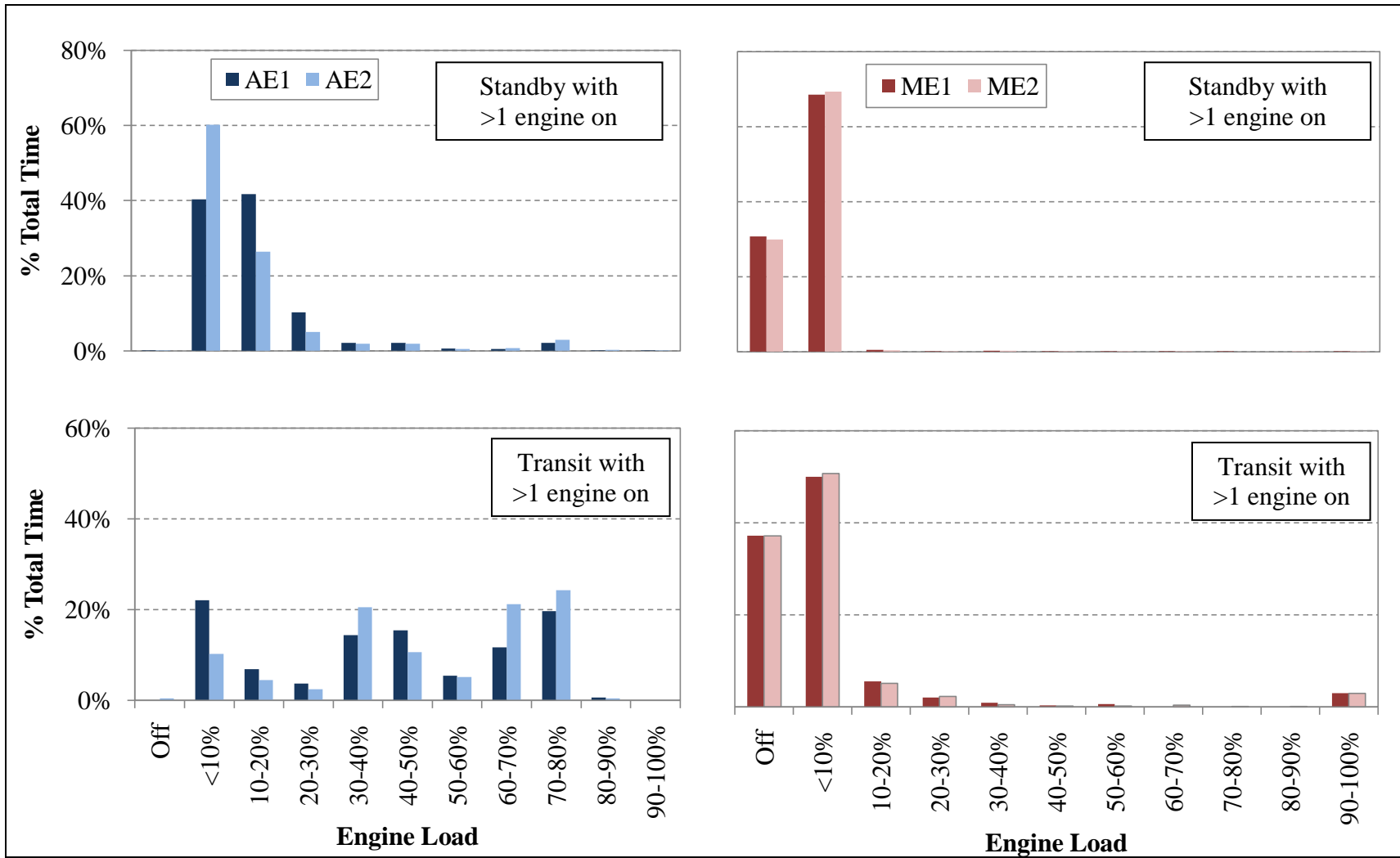


Figure 3-6 Engine Histograms for the Hybrid Tug-2

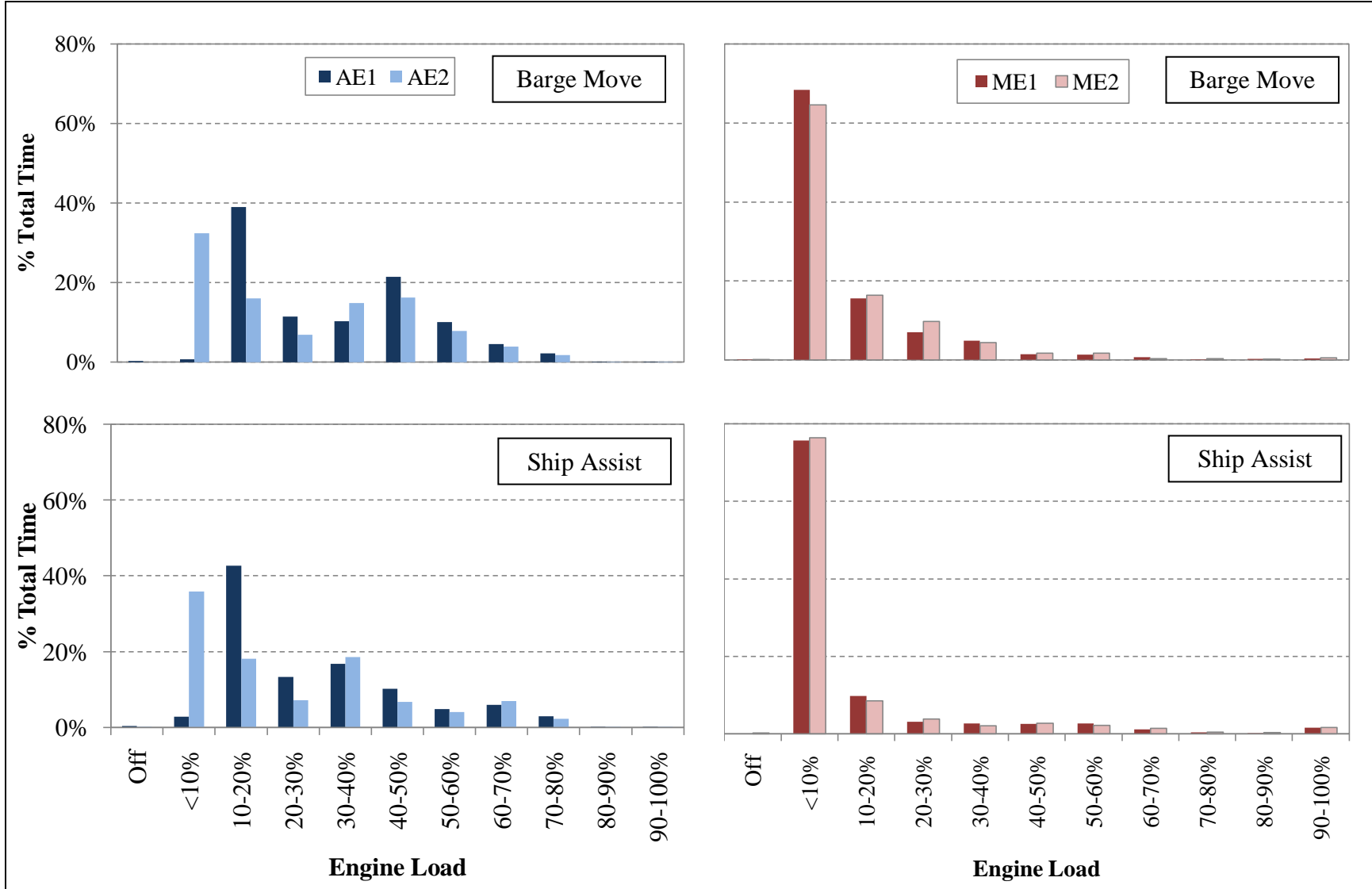


Figure 3-7 Engine Histograms for the Hybrid Tug-3

### 3.1.4 Engine Histograms for Hybrid Tug without Batteries

The hybrid tug was operated for a period of ~1.5 days with the batteries disconnected from the diesel electric drive train. During this time the tug performed four ship assists and six barge moves. This was done to determine the effect of the drive train versus the energy storage device (batteries). Figures 3-8 through 3-10, show engine histograms of the hybrid tug operating without the batteries. The average load required for a barge move and ship assist without batteries were found to be 641kW and 475kW. These are comparable to the loads seen with the hybrid tug with batteries. Therefore, the primary cause for the reduction in average load needed for these operations can be attributed to the diesel electric drive train.

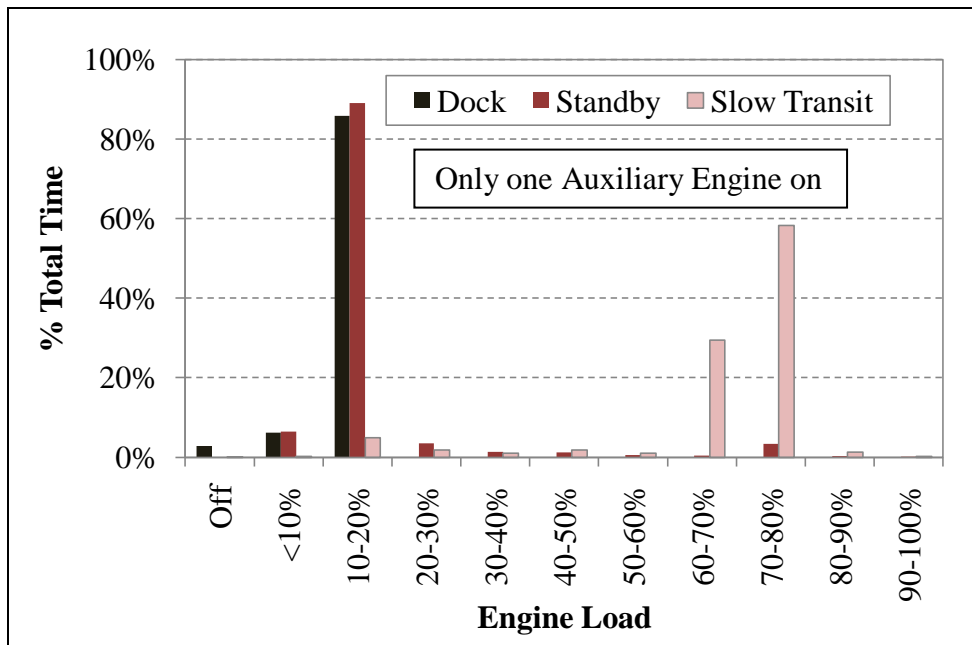


Figure 3-8 Engine Histograms for Hybrid Tug without Batteries - 1

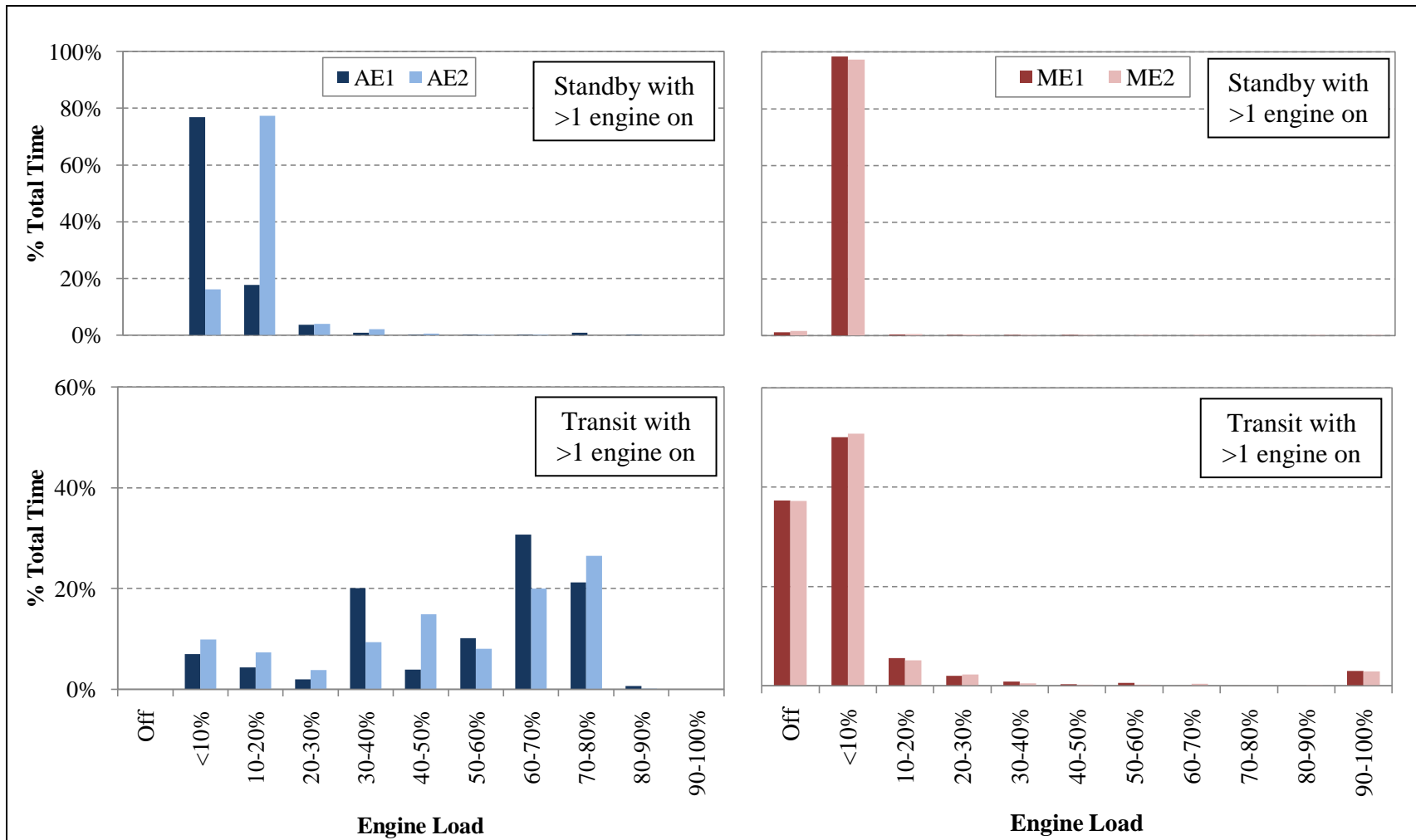


Figure 3-9 Engine Histograms the Hybrid Tug without Batteries -2

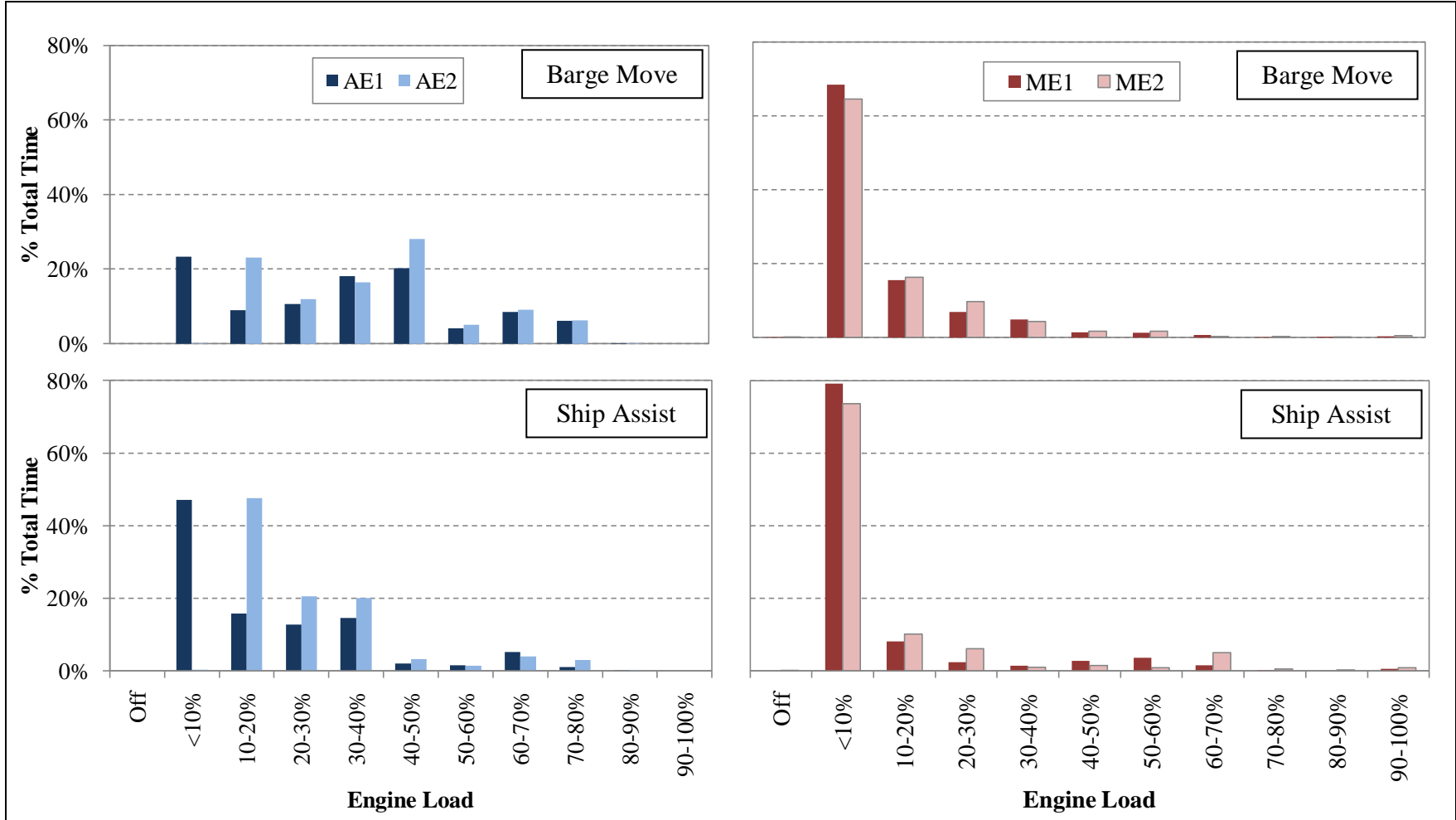


Figure 3-10 Engine Histograms for the Hybrid Tug without Batteries -3

## 3.2 Emissions Testing

### 3.2.1 Test Fuel Properties

Table 3-3 shows the results of the analysis of the fuel samples obtained from the conventional and hybrid tug. The density and carbon content shown here were used for performing carbon balance calculations on the test engines.

**Table 3-3 Selected Fuel Properties**

<i>Fuel</i>	<i>Analysis Method</i>	<i>Diesel from Conventional Tug</i>	<i>Diesel from Hybrid Tug</i>
<b>API Gravity @60 °F</b>	ASTM D4052	38.2	38.7
<b>Specific Gravity @50 °F</b>	ASTM D4052	0.8338	0.8316
<b>Density @ 15.525 °C (kg/m<sup>3</sup>)</b>	ASTM D4052	0.8333	0.8311
<b>Sulfur, ppm</b>	ASTM D 2622	9.2	17.4
<b>Carbon wt%</b>	ASTM D 5291	86.14	86.02
<b>Hydrogen wt%</b>	ASTM D 5291	13.56	13.60

### 3.2.2 Emissions Testing Phase 1

The primary gaseous emissions measured during this test program include a greenhouse gas carbon dioxide (CO<sub>2</sub>), and the criteria pollutants: nitrogen oxides (NO<sub>x</sub>), carbon monoxide (CO)). Each of these gaseous species was measured using the ISO standard instrumentation (Appendix A, Section A.6). In addition to gaseous emissions, the total PM<sub>2.5</sub> mass emissions and the speciated PM<sub>2.5</sub> emissions as elemental carbon (EC) and organic carbon (OC) were measured. As described earlier, the PM<sub>2.5</sub> mass in the raw exhaust was sampled using a partial dilution method and collected on filter media. A detailed list of the modal gaseous and PM<sub>2.5</sub> emissions in g/hr and g/kW-hr, for the four test engines are provided in Tables 3-4 and 3-5 respectively.

Duplicate/triplicate measurements were made at steady state test mode. Each gaseous measurement was a three to five minute average of one hertz data obtained from the instrument. The standard deviation of three to five minute averages was <2% for CO<sub>2</sub>. This indicates that the load on the engine while testing that mode was steady, thereby validating the measurement at each of those test modes. In the case of PM<sub>2.5</sub>, each measurement refers to a filter sample. The standard deviation/range across these duplicate/triplicate measurements is shown as error bars in the Figures 3-11 through 3-14.

Table 3-5 lists the overall weighted average emission factors for each of the test engines. It also shows the manufacturer's published emission factors and the EPA Tier 2 standard for that each test engine family. The overall weighted average NO<sub>x</sub> emission factors for the test engines range from 7.1 to 7.8 g/kW-hr. These factors are just below (for CAT 3512 C) or greater than the EPA Tier 2 standard for the sum of NO<sub>x</sub> and total



hydrocarbon (THC) emissions of 7.2 g/kW-hr. The weighted average PM<sub>2.5</sub> emission factors for the CAT 3512 C and Cummins engines, ranging from 0.053 to 0.097 g/kW-h, are well below the EPA Tier 2 standard of 0.20 g/kW-hr. The JD 6081 auxiliary engine however reported an overall weighted average PM<sub>2.5</sub> emission factor of 0.24 g/kW-hr which is greater than the emissions standard. The measured emissions factors for the CAT 3512 C engine are comparable to the manufacturer's published values. For the Cummins engines, we find that the measured NO<sub>x</sub> emission factors are larger and PM<sub>2.5</sub> emission factors smaller than the manufacturer's numbers.

**Table 3-4** Results for Phase 1 of Emissions Testing in g/hr

<b>Target Load</b>	<b>Actual Load</b>	<b>NO<sub>x</sub> (g/hr)</b>	<b>CO (g/hr)</b>	<b>CO<sub>2</sub> (kg/hr)</b>	<b>PM<sub>2.5</sub> (g/hr)</b>	<b>EC (g/hr)</b>	<b>OC (g/hr)</b>
<b>Main Engine on Conventional Tug CAT 3512 C</b>							
Idle	7%	2439	136	98	6.3	1.7	5.3
25%	30%	4867	1324	402	94	3.9	108
50%	52%	7781	2774	681	195	90	105
75%	75%	9450	1015	1005	97	54	51
100%	100%	14124	1414	1325	173	101	100
<b>Auxiliary Engine on Conventional Tug JD 6081</b>							
10%	11%	156	54	16	5.1	0.25	4.5
25%	26%	300	64	39	19.1	9.4	9.8
50%	40%	702	122	74	19.5	10.2	12.7
75%	71%	1224	251	106	28.0	7.2	19.2
<b>Main Engine on Hybrid Tug Cummins QSK50-M</b>							
Idle	7%	1035	110	75	9.5	7.2	4.6
25%	26%	2674	318	262	9.8	6.2	6.9
50%	49%	5374	1054	541	50	36	22
75%	75%	7921	1608	799	58	39	29
100%	99%	10215	1236	1078	54	30	37
<b>Auxiliary Engine on Hybrid Tug Cummins QSM11-M</b>							
25%	27%	600	66	65	9.8	6.6	4.1
50%	51%	1191	63	117	8.0	4.2	5.4
75%	73%	1729	69	173	9.1	4.9	6.4

**Table 3-5** Emission Factors in g/kW-hr from Phase 1 of Testing

Target Load	Actual Load	NO <sub>x</sub>	CO	CO <sub>2</sub>	PM <sub>2.5</sub>	EC	OC
<b>Main Engine on the Conventional Tug CAT 3512 C</b>							
Idle	7%	17.5	0.98	704	0.045	0.012	0.038
25%	30%	8.5	2.32	704	0.164	0.034	0.161
50%	52%	7.8	2.78	682	0.195	0.090	0.105
75%	75%	6.6	0.71	705	0.068	0.038	0.036
100%	100%	7.4	0.74	697	0.091	0.036	0.064
<b>Wt. Avg.</b>		<b>7.1</b>	<b>1.1</b>	<b>701</b>	<b>0.097</b>	<b>0.047</b>	<b>0.059</b>
<i>Manf. Wt Avg. Nominal</i>		<i>6.31</i>	<i>0.49</i>	<i>657</i>	<i>0.10</i>	<i>n.a</i>	<i>n.a</i>
<i>Manf. Wt Avg. NTE</i>		<i>7.57</i>	<i>0.89</i>	<i>n.a</i>	<i>0.12</i>	<i>n.a</i>	<i>n.a</i>
<i>EPA Tier 2 Std</i>		<i>7.2*</i>	<i>5.0</i>	<i>n.a.</i>	<i>0.20</i>	<i>n.a</i>	<i>n.a</i>
<b>Auxiliary Engine on the Conventional Tug JD 6081</b>							
10%	11%	5.9	1.28	771	0.38	0.19	0.19
25%	26%	7.3	1.27	774	0.20	0.11	0.13
50%	40%	8.9	1.83	773	0.20	0.05	0.14
75%	71%	7.3	2.52	746	0.24	0.01	0.21
<b>Wt Avg</b>		<b>7.7</b>	<b>1.54</b>	<b>772</b>	<b>0.24</b>	<b>0.09</b>	<b>0.15</b>
<i>EPA Tier 2 Std</i>		<i>7.2*</i>	<i>5.0</i>	<i>n.a</i>	<i>0.20</i>	<i>n.a</i>	<i>n.a</i>
<b>Main Engine on the Hybrid Tug Cummins QSK50-M</b>							
Idle	7%	11.0	1.2	792	0.101	0.077	0.049
25%	26%	7.7	0.9	756	0.028	0.018	0.020
50%	49%	8.2	1.6	823	0.075	0.055	0.033
75%	75%	7.9	1.6	799	0.058	0.039	0.029
100%	99%	7.7	0.9	812	0.041	0.022	0.028
<b>Wt. Avg.</b>	<b>n.a</b>	<b>7.8</b>	<b>1.4</b>	<b>798</b>	<b>0.053</b>	0.034	0.026
<i>Manf. Wt Avg.</i>		<i>6.53</i>	<i>0.81</i>	<i>n.a</i>	<i>0.09</i>	<i>n.a</i>	<i>n.a</i>
<i>EPA Tier 2 Std</i>		<i>7.2*</i>	<i>5.0</i>	<i>n.a</i>	<i>0.20</i>	<i>n.a</i>	<i>n.a</i>
<b>Auxiliary Engine on Hybrid Tug Cummins QSM11-M</b>							
25%	27%	7.0	0.8	765	0.116	0.078	0.048
50%	51%	7.4	0.4	725	0.050	0.026	0.034
75%	73%	7.5	0.3	749	0.039	0.021	0.028
<b>Wt. Avg.</b>		<b>7.41</b>	<b>0.44</b>	<b>744</b>	<b>0.058</b>	<b>0.034</b>	<b>0.034</b>
<i>Manf. Wt Avg.</i>		<i>6.289</i>	<i>0.362</i>	<i>n.a</i>	<i>0.134</i>	<i>n.a</i>	<i>n.a</i>
<i>EPA Tier 2 Std</i>		<i>7.2*</i>	<i>5.0</i>	<i>n.a</i>	<i>0.20</i>	<i>n.a</i>	<i>n.a</i>

*Manf. Wt Avg.* Manufacturer's Weighted Average, *NTE* Not to Exceed  
 \* Standard if for the sum of nitrogen oxides and total hydrocarbon emissions

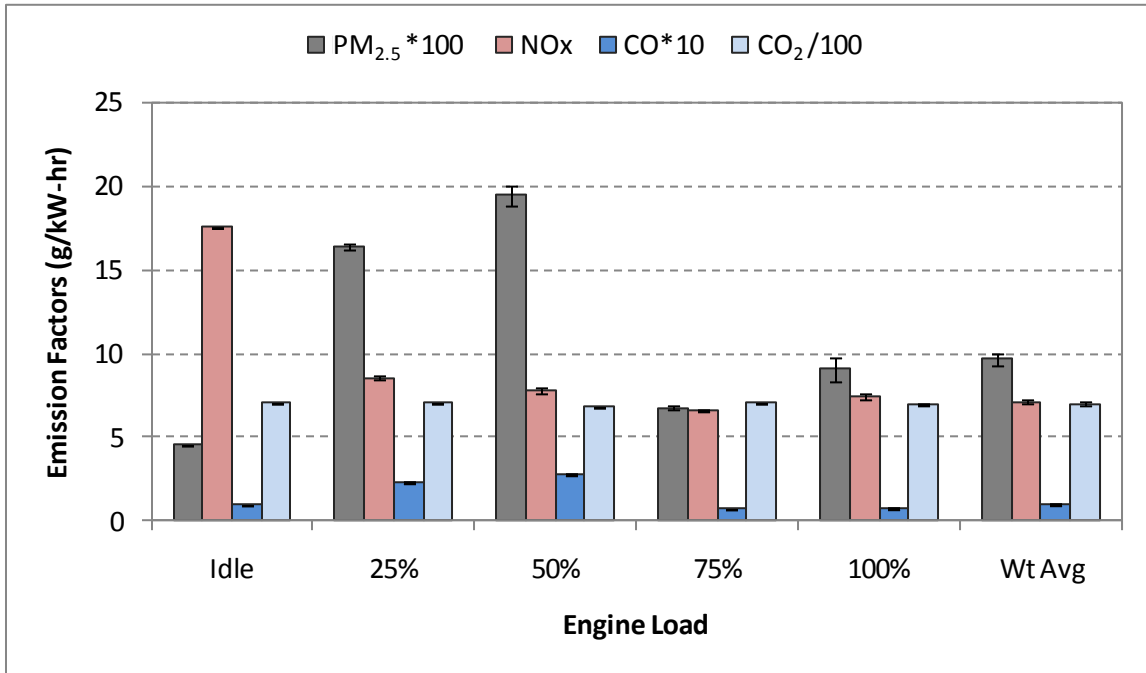


Figure 3-11 Emission Factors for Main Engine on Conventional Tug CAT 3512C

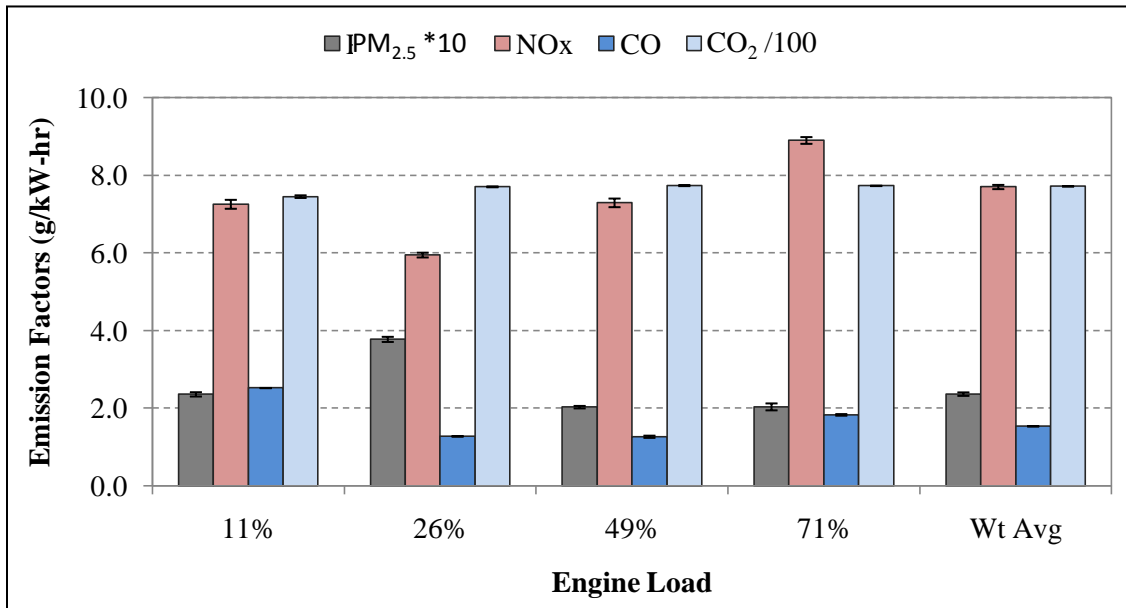


Figure 3-12 Emission Factors for Auxiliary Engine on Conventional Tug JD 6081

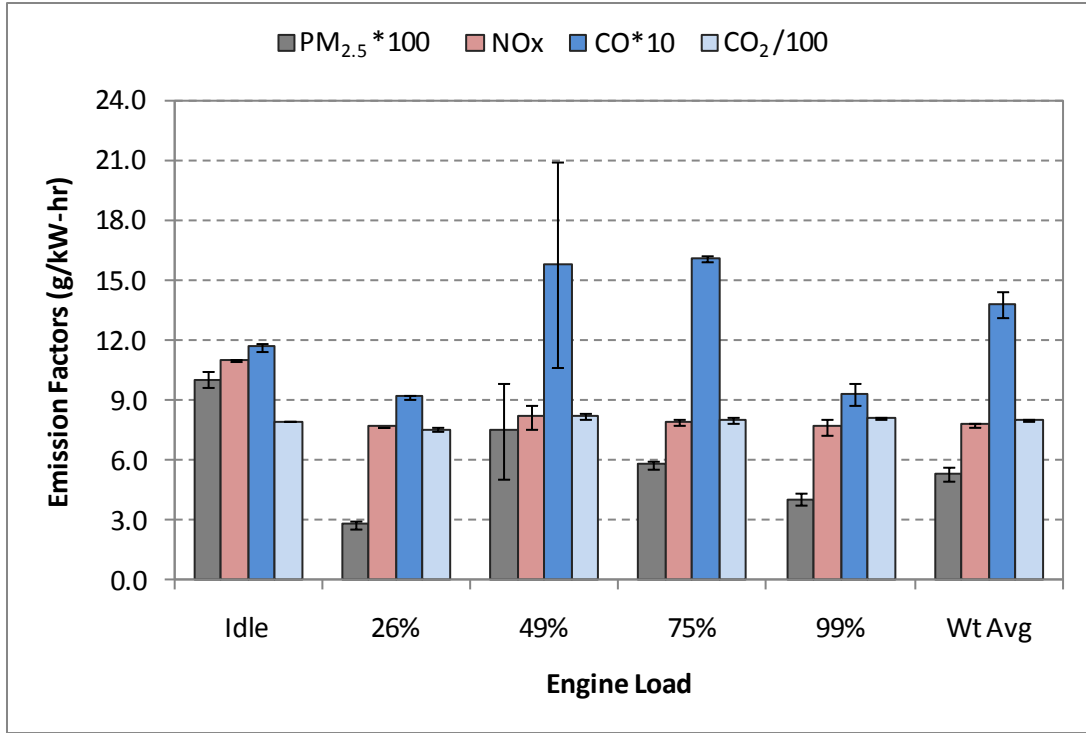


Figure 3-13 Emission Factors for Main Engine on Hybrid Tug Cummins QSK50-M

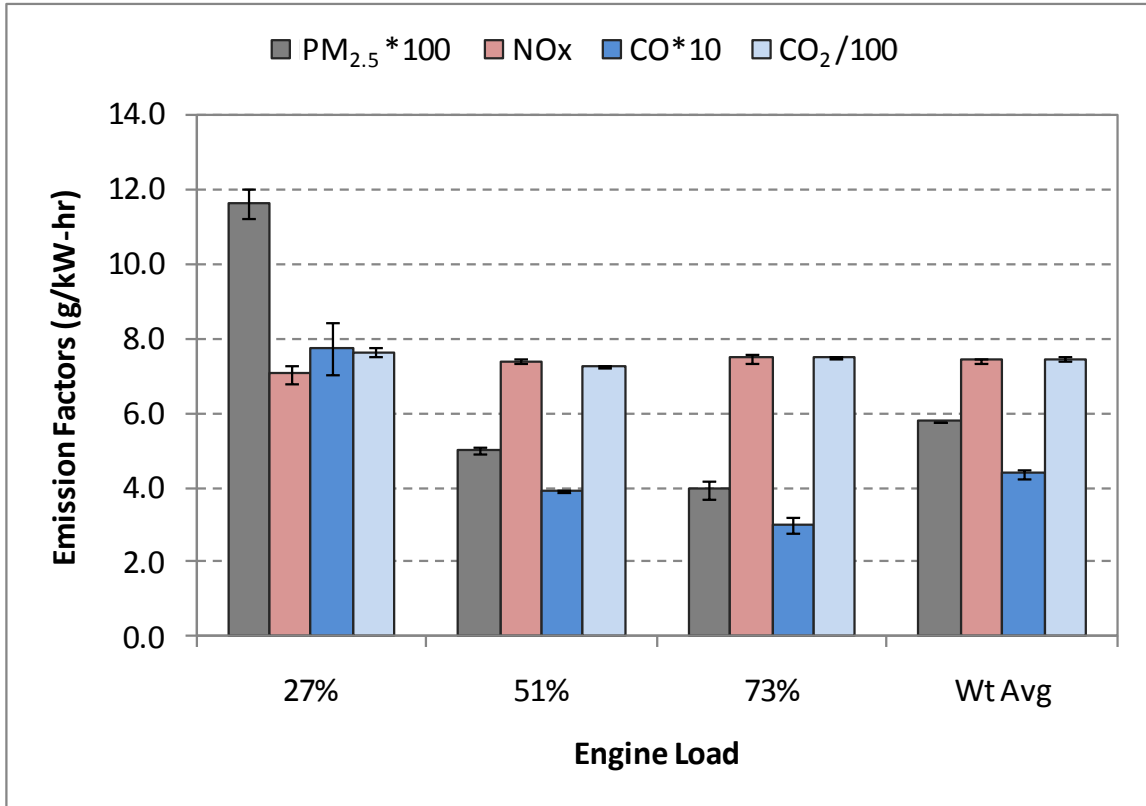
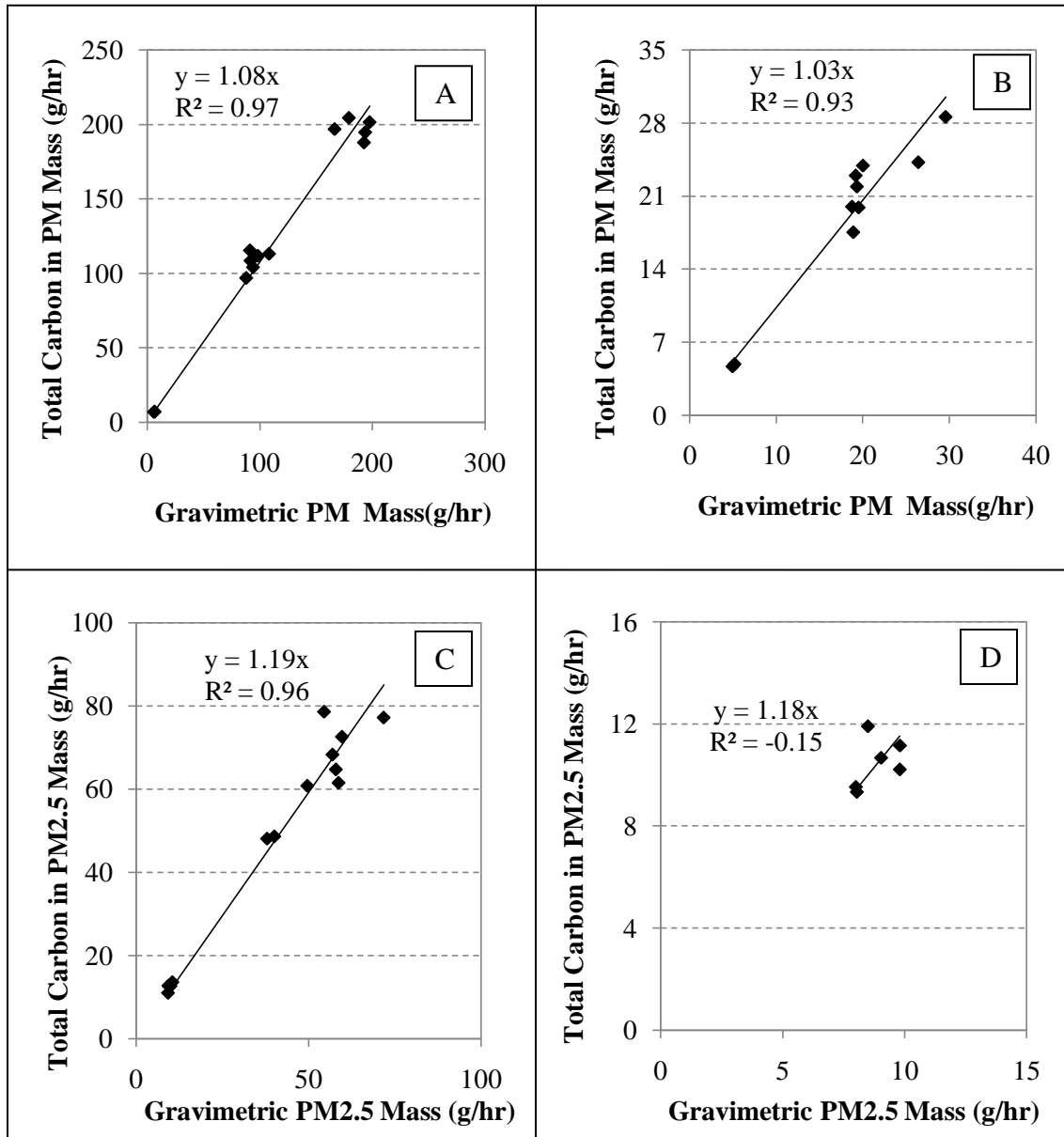


Figure 3-14 Emission Factors for Auxiliary Engine on Hybrid Tug QSM11-M

Diesel particulate matter primarily consists of elemental and organic carbon. Figure 3-15 shows a plot of the PM<sub>2.5</sub> emissions in g/hr obtained from two separate methods – gravimetric measurements of PM<sub>2.5</sub> collected on Teflo® filters and total carbon analysis of PM<sub>2.5</sub> collected on parallel Tissuquartz filters. These plots show that the total carbon associated with PM<sub>2.5</sub> is 3 to 19% greater than the total PM<sub>2.5</sub> mass. This discrepancy can be attributed to the positive organic artifact associated with the Tissuquartz filters. Overall, PM<sub>2.5</sub> measurements made by these two methods are in good agreement, thereby increasing confidence in the measurement methods.



**Figure 3-15** PM<sub>2.5</sub> Mass Balance for A) Main Engine Conventional Tug CAT 3512 C B) Auxiliary Engine Conventional Tug JD 6081 C) Main Engine Hybrid Tug Cummins QSK50-M D) Auxiliary Engine Hybrid Tug Cummins QSM11-M

### 3.2.3 Emissions Testing Phase 2

The goal of emissions testing Phase 2 was to determine an emissions profile of the test engines across their whole operating range. As mentioned in Section 2.6.3 the auxiliary engine on the conventional tug was not tested in Phase 2 as it operates only at the 12% load point which was characterized during Phase 1. The other three engines were tested at several steady state load points across their entire operating range including those from Phase 1.

During this phase gaseous emissions of carbon dioxide, nitrogen oxides and carbon monoxide were measured based on the ISO methods. Real-time PM<sub>2.5</sub> mass concentrations were measured using TSI's DustTrak. One five minute measurement was made at each test mode. This measurement is an average of one hertz data obtained from the gas and PM analyzers for the entire sample time. The standard deviation in the CO<sub>2</sub> measurement at each test mode was determined to be <2% indicating that the engine was indeed at steady state during sampling. Test results are provided in Table 3-6.

Figures 3-16, 3-17 and 3-18 show a comparison of the engine load, gaseous emissions and PM<sub>2.5</sub> concentrations in the raw exhaust from Phases 1 and 2. For all three engines the CO<sub>2</sub> and NO<sub>x</sub> emissions from the two phases are found to be in good agreement. The slightly higher CO<sub>2</sub> emissions in Phase 2 can be attributed to the increase in the engine load. The CO emissions for the two main engines obtained from the two phases were not comparable. Therefore the CO emissions were not used in the final analysis.

Gravimetric PM<sub>2.5</sub> measurements made in Phase 1 using Teflo<sup>®</sup> filters followed the ISO reference methods. Measurements made in Phase 2 using TSI's DustTrak give an indication of the trends across engine loads but do not provide accurate numbers. Therefore trend-lines showing variation in PM<sub>2.5</sub> concentrations as a function of engine load were plotted through the gravimetric filter measurements following the trends obtained from real-time measurements in Phase 2. These trend-lines are shown in Figures 3-16 through 3-18. PM<sub>2.5</sub> concentration (mg/m<sup>3</sup>) in the raw exhaust, for each test mode in Phase 2, was calculated using these trend-lines. Finally the PM<sub>2.5</sub> emissions in g/hr were determined using these calculated concentrations and exhaust flows.

Figures 3-19, 3-20 and 3-21 show the variation in gaseous and PM<sub>2.5</sub> mass emissions in g/hr as a function of engine load. These emission profiles are used along with the engine histograms to determining the total emissions from each engine at the different tug operating modes.

**Table 3-6** Results of Phase 2 of Emissions Testing

Speed (rpm)	Actual Load (kW)	% Max Load	NOx (g/hr)	CO (g/hr)	CO <sub>2</sub> (kg/hr)	DustTrak PM <sub>2.5</sub> (mg/m <sup>3</sup> )	PM <sub>2.5</sub> <sup>a</sup> (mg/m <sup>3</sup> )	PM <sub>2.5</sub> <sup>b</sup> (g/hr)
<b>Main Engine on Conventional Tug CAT 3512 C</b>								
1779	1899	100%	14763	3588	1395	n.a	18.2	190
1655	1509	79%	11191	1203	1102	22.1	13.4	114
1542	1272	67%	10406	2139	900	22.7	22.8	152
1434	1031	54%	9172	3015	741	37.9	39.0	202
1301	815	43%	7739	3002	605	49.0	51.5	207
1142	655	34%	5190	3057	478	31.0	40.5	125
1103	588	31%	5023	1940	429	23.2	35.8	105
1000	453	24%	4640	698	331	17.2	26.5	67.7
901	357	19%	4053	388	261	8.3	19.8	44.8
803	263	14%	3271	286	192	4.3	13.3	26.0
701	190	10%	3050	195	139	0.24	8.3	14.0
650 <sup>a</sup>	162	9%	2832	163	118	0.00	6.3	9.9
650 <sup>b</sup>	51	3%	921	203	37	0.16	4.7	7.3
<b>Main Engine on Hybrid Tug Cummins QSK50-M</b>								
1782	1328	99%	10215	1236	1078	n/a	6.8	55.2
1766	1284	96%	9680	1732	1060	22.2	7.1	54.7
1684	1283	96%	9981	1944	1037	15.9	7.1	51.7
1607	1111	83%	8638	2192	890	24.2	8.5	52.0
1525	935	70%	7154	2184	770	21.8	9.8	50.9
1424	755	56%	5013	2181	637	25.7	11.2	47.3
1298	515	38%	4410	955	482	8.3	9.8	28.8
1142	338	25%	2867	332	308	3.5	7.1	14.3
1050	269	20%	2317	170	226	4.4	6.0	10.1
949	202	15%	1986	123	159	4.2	5.0	7.2
851	133	10%	1450	122	109	3.2	8.0	9.9
748	83	6%	1056	112	83	3.9	9.5	10.0
650 <sup>a</sup>	104	8%	1100	145	96	12.4	9.7	8.9
650 <sup>b</sup>	21	2%	179	50	18	0.8	4.4	4.0
<b>Auxiliary Engine on Hybrid Tug QSM11-M</b>								
1808	234	74%	1745	72	181	11.6	7.7	9.3
1813	193	61%	1518	66	153	9.4	8.2	8.7
1817	154	49%	1163	67	126	11.8	9.0	8.4
1820	127	40%	1004	68	108	15.1	10.9	9.2
1824	83	26%	651	71	77	13.2	13.7	9.6
1825	68	21%	555	72	65	10.1	11.2	7.3
1832	19	6%	216	85	20	3.7	3.1	1.5

<sup>a</sup> Obtained from trend-lines for gravimetric PM<sub>2.5</sub> (Figures 3-16, 3-17, 3-18)

<sup>b</sup> Calculated using PM<sub>2.5</sub><sup>a</sup> concentrations

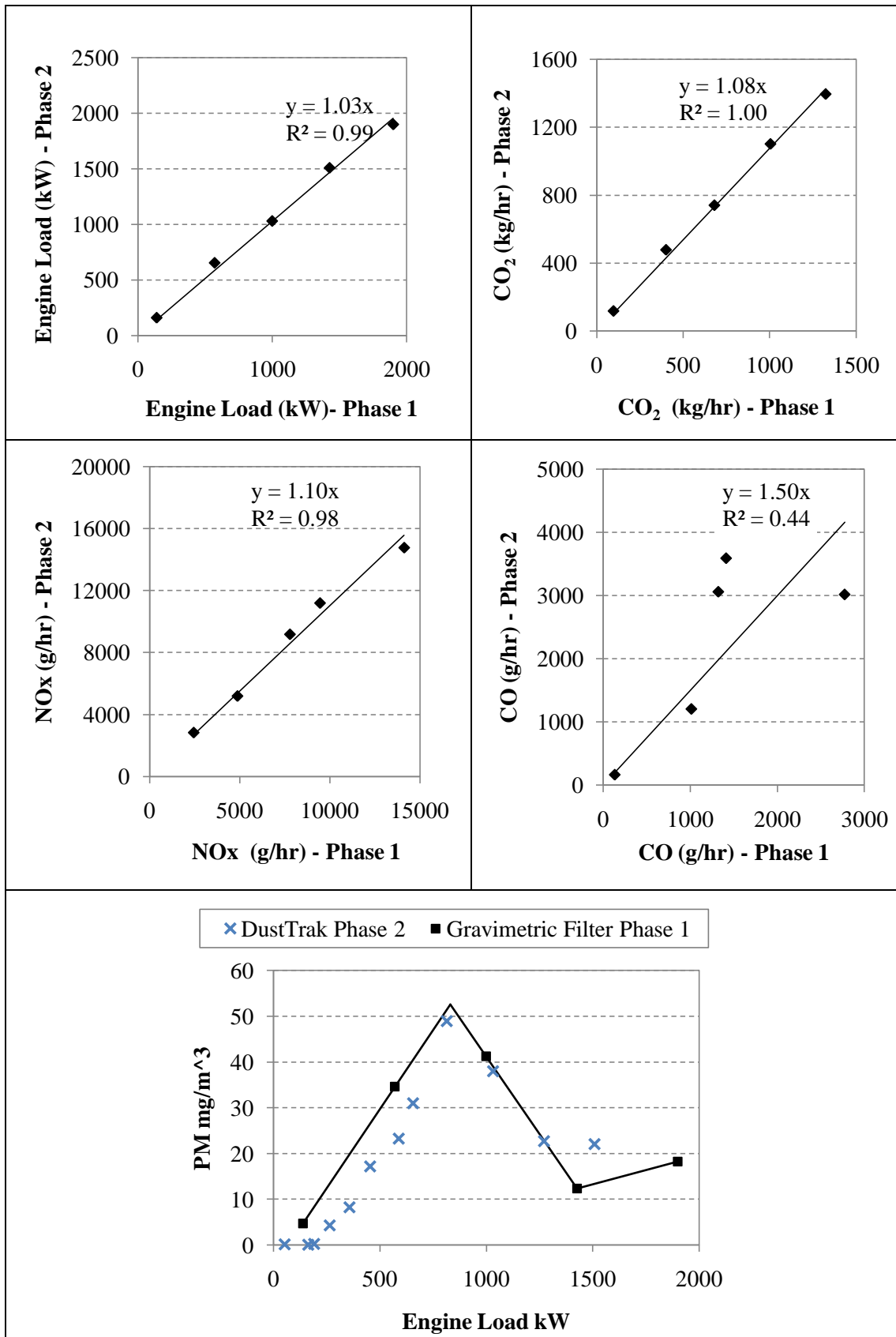


Figure 3-16 Comparison of Phases 1 & 2 for Main Engine on Conventional Tug CAT 3512 C



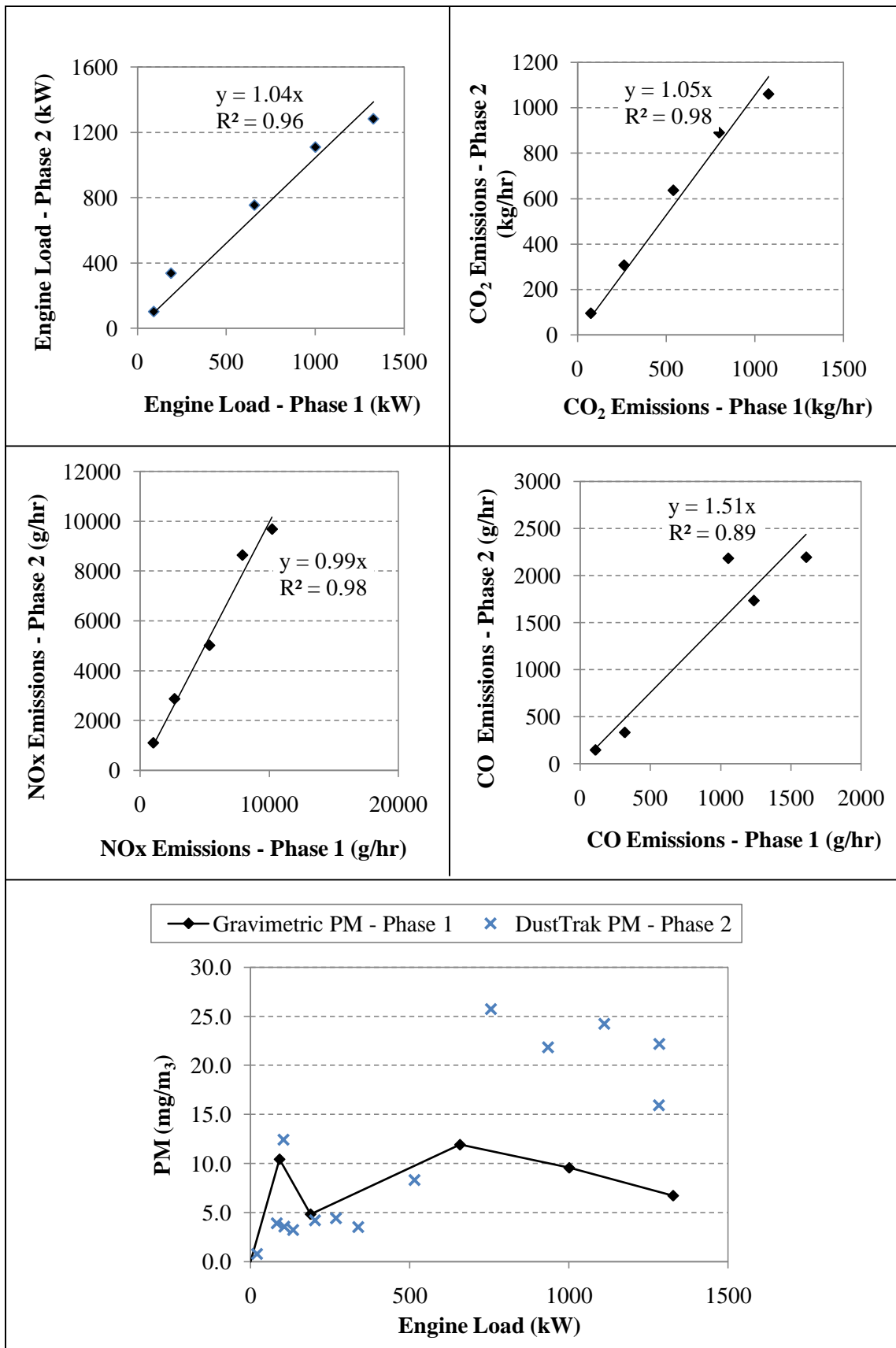
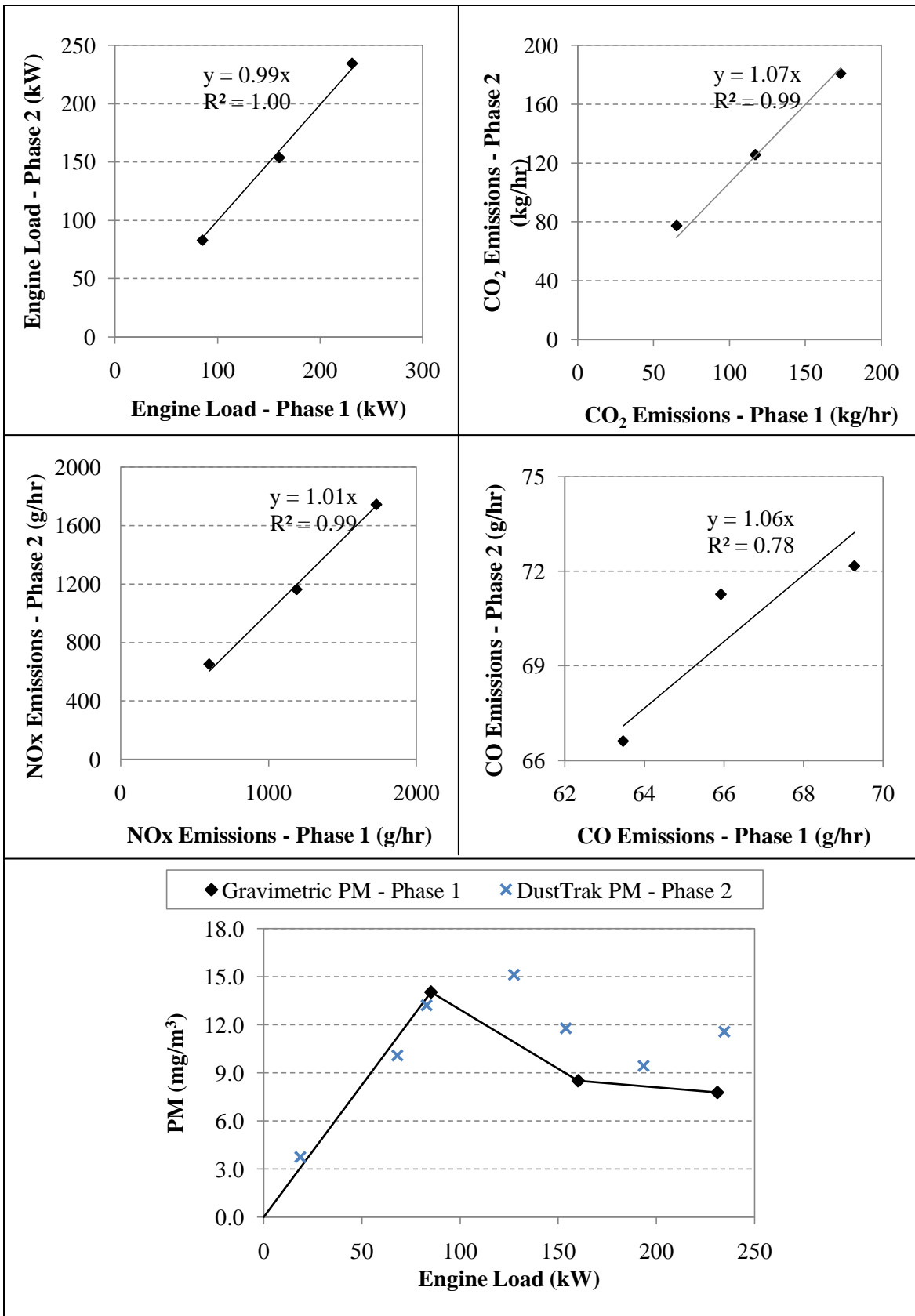


Figure 3-17 Comparison of Phases 1 & 2 for Main Engine of Hybrid Tug Cummins QSK50-M



**Figure 3-18** Comparison of Phases 1 & 2 for Auxiliary Engine on Hybrid Tug Cummins QSM11-M

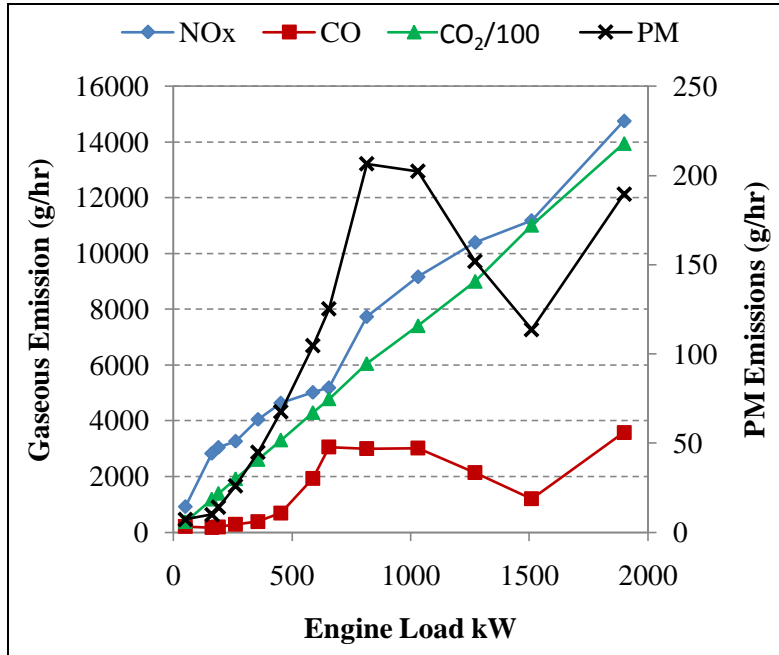


Figure 3-19 Emissions Profile for Main Engine on Conventional Tug CAT 3512 C

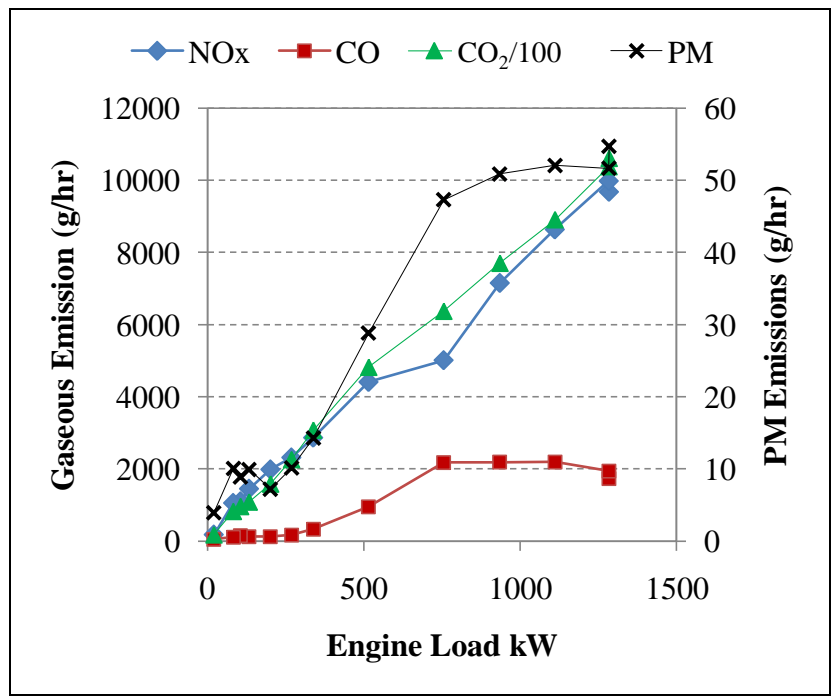


Figure 3-20 Emissions Profile of Main Engine on Hybrid Tug QSK50-M

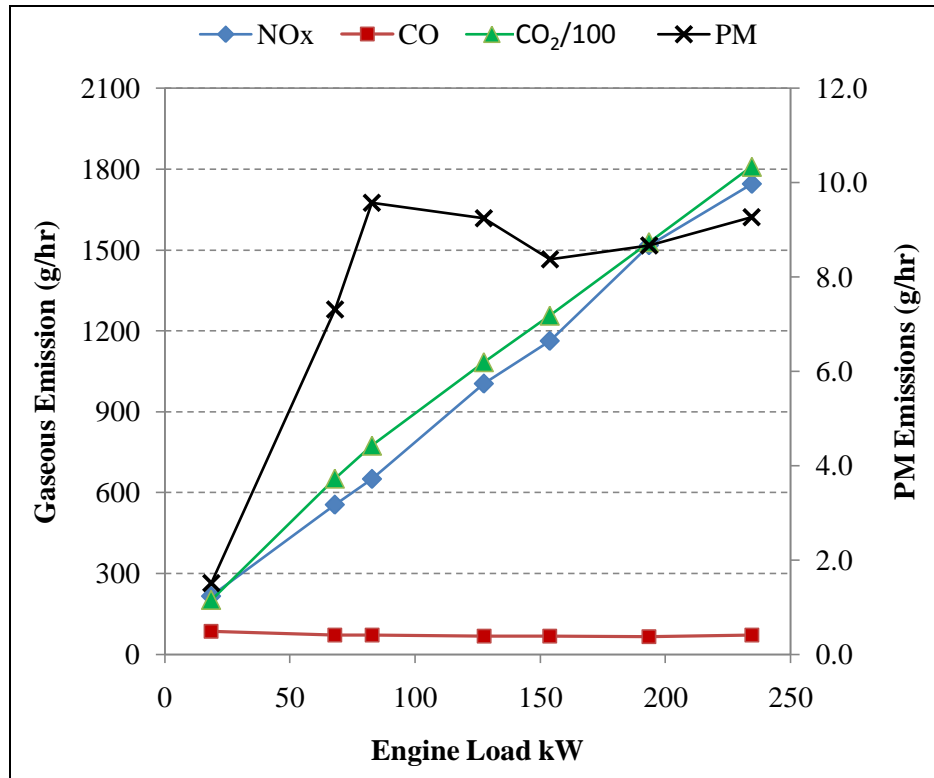


Figure 3-21 Emissions Profile of Auxiliary Engine on Hybrid Tug Cummins QSK11-M

### 3.2.4 Carbon Balance

As a part of the UCR’s QA/QC the mass balance between the carbon in the fuel and the carbon measured in the exhaust is checked. For this project the fuel flow was not directly measured, instead the instantaneous fuel flow rate in cubic centimeters per minute was retrieved from the engine ECM. The carbon from the fuel in g/hr was calculated using this fuel flow data along with the carbon content and density of fuel obtained from the fuel sample analysis (Section 3.2.1). Approximately 99% of the carbon from the fuel is converted to CO<sub>2</sub>. The amount of carbon in the exhaust was calculated from the measured CO<sub>2</sub> and CO emissions.

As mentioned in Section 2.6.6, we were unable to retrieve the inlet air and temperature readings from ECM of the auxiliary engine on the conventional tug JD 6081. The exhaust flow rate for this engine was estimated the instantaneous fuel flow data from its ECM. Therefore a plot of the carbon from the fuel versus the carbon measured in the exhaust will merely yield a 1-1 line. Hence, this engine is not included in this analysis.

Plots of the carbon in the fuel versus the carbon in the exhaust for the other three test engines, obtained from both phases of emissions testing, are plotted in Figure 3-22. The ECM data was found to be 13% to 16% lower than the measured carbon in the exhaust for the main engines and 5% higher for the auxiliary engine on the hybrid. For most diesel engines the correlation between fuel flow and carbon in the exhaust will be < 2%. In this test, the fuel flow was not measured. The engine ECM provides an estimate of the

fuel flow based on other engine parameters. The discrepancy in the correlation shows a bias in this fuel flow estimation

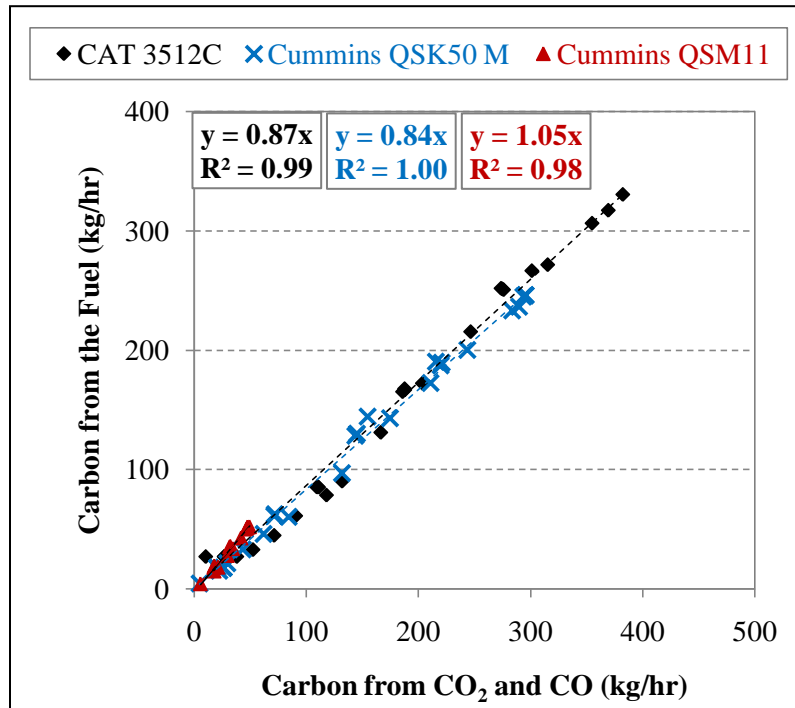


Figure 3-22 Carbon Balance for Test Engines

### 3.3 Total In-Use Emissions

The total in-use emission from each tug was calculated using the equations stated in Section 2.2. Emissions from each tug at a particular operating mode were calculated using engine histograms and engine emission profile data. To determine the emissions for the shore power mode, the average load for each tug at shore power (Table 3-7) was multiplied by the emission factors of a conventional natural gas fired steam plants with selective catalytic reduction (SCR) for NO<sub>x</sub> control and with no CO catalyst (Table 3-8).

Table 3-7 Average Load Requirements for Each Operating Mode

Operating Modes	Average Load (kW)		
	Conventional Tug	Hybrid Tug without Batteries	Hybrid Tug
Dock	22	34	29
Standby	184	111	74
Transit	718	409	278
Assist	608	476	508
Barge Move	754	641	507

**Table 3-8** Emission Factors for Shore Power<sup>17, 18</sup>

	<i>Emission Factor</i>		
	lbs/10 <sup>6</sup> scf	lbs/MW-hr <sup>a</sup>	g/kW-hr
<i>PM</i> <sub>2.5</sub>	7.6	0.087	29
<i>NO</i> <sub>x</sub>	10	0.117	74
<i>CO</i> <sub>2</sub>	120000	1371	278

<sup>a</sup> heating value of natural gas = 1,050 Btu/scf, power generation heat rate = 12,000 Btu/kW-hr

Table 3-9 lists the calculated emissions in g/hr of NO<sub>x</sub>, PM<sub>2.5</sub> and CO<sub>2</sub> at each operating mode for the conventional tug, hybrid tug and hybrid tug without batteries. The table also provides overall emissions from each tug calculated based on individual and average weighing factors for each operating mode.

The reductions in overall PM<sub>2.5</sub>, NO<sub>x</sub> and CO<sub>2</sub> emissions for the hybrid tug compared to the conventional tug was found to be 73%, 51% and 27% respectively. The tug company saw a fuel savings of about 25-28% while comparing conventional tug with the hybrid over an eight month period. The CO<sub>2</sub> reductions calculated from this study are in good agreement with the fuel savings seen by the tug owner, thereby increasing confidence in the test protocol and analysis technique.

The initial hypothesis for the emissions reduction was as follows: Conventional tug spend considerable amount of time in the standby mode with one auxiliary engine and two main engines idling. The hybrid tug switches between batteries and one auxiliary. So a significant fraction of the emission savings would occur in this mode.

The final results show that the tugs spend only 7% of their total time in this mode. As a result, its contribution to the overall emission reductions was found to be small ~4% for PM<sub>2.5</sub> and ~14% for NO<sub>x</sub> and CO<sub>2</sub>. The transit mode was found to be the largest contributor to the overall emission reductions ~50% for PM<sub>2.5</sub>, ~53% for NO<sub>x</sub>, ~78% for CO<sub>2</sub>. This is due to the significantly lower loads required to transit with the hybrid tug versus the conventional tug (Table 3-7).

The emission reductions results for the hybrid tug operating without batteries show that the bulk of the emission savings (97% for PM<sub>2.5</sub>, 95% for NO<sub>x</sub>, 70% for CO<sub>2</sub>) is a result of the diesel electric drive train and not the batteries. The diesel electric drive train allows auxiliary power to be used for propulsion. This reduces the total load requirement for the transit and standby operations significantly thereby reducing the overall emissions from the tug.

Since the conventional tug and the hybrid tug have engines from different engine manufacturers with different power ratings a couple of retrofit scenarios were modeled.

*Retrofit scenario 1:* This scenario assumes that both tugs have the same set of engines. For this purpose the main and auxiliary engine with the higher power ratings, CAT 3512 C main engines and Cummins QSK11-M auxiliary engines, were chosen. The emission profiles of the chosen engines were coupled with the engines histograms for each tug to

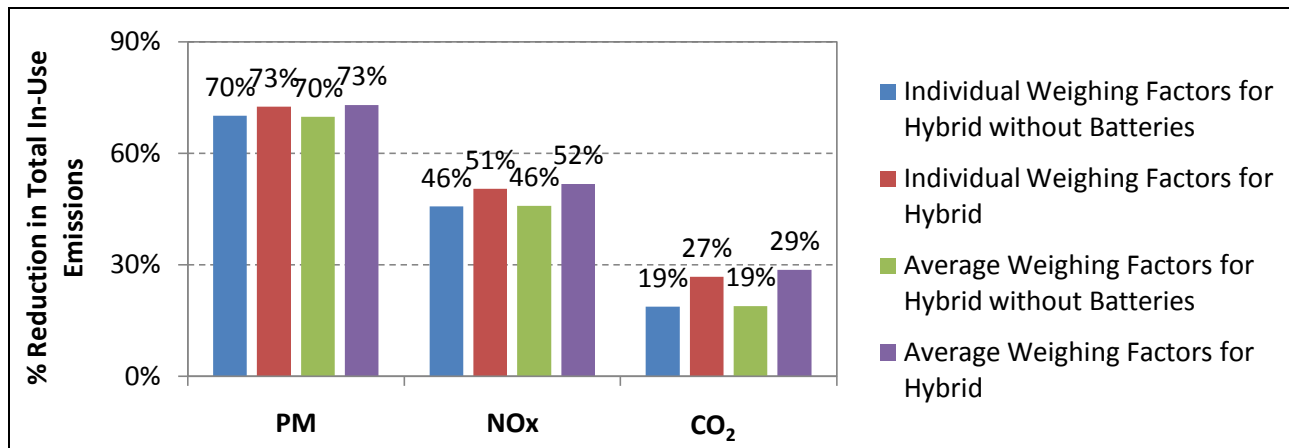
determine the total emissions at each operating mode (Table 3-10). These were then multiplied by the individual and average weighting factors to determine the overall in-use emissions for this scenario. The reductions in the overall in-use emissions calculated based on average weighting factors was found to be 58%, 39%, 32% for PM<sub>2.5</sub>, NO<sub>x</sub> and CO<sub>2</sub> respectively. The reductions in PM<sub>2.5</sub> and CO<sub>2</sub> increased while that of NO<sub>x</sub> decreased in this scenario when compared to the actual numbers. Again we find that the bulk of the reductions occur in the transit mode. Also most of the reductions are a result of the energy management system rather than the batteries.

*Retrofit Scenario 2:* Conventional tugs typically have auxiliary engines with a lower power rating like the JD 6081. Therefore, a more realistic retrofit scenario would be: Conventional tug powered by CAT 3512 C main engines and the JD 6081 auxiliaries; Hybrid tug powered by CAT 3512 C main engines and the Cummins QSK11-M auxiliaries. Results for this retrofit scenario 2 are provided in Table 3-11. The reduction in the overall in-use emissions seen in Retrofit Scenario 2 was found to be similar to that of Retrofit Scenario 1.

**Table 3-9** Modal and Overall Emission Reductions with Hybrid Technology

Operating Mode	Operating Mode Weighting Factors			PM <sub>2.5</sub> (g/hr)			NO <sub>x</sub> (g/hr)			CO <sub>2</sub> (kg/hr)		
	Con.	Hyb.	Average	Con.	Hyb_NB	Hyb.	Con.	Hyb_NB	Hyb.	Con.	Hyb_NB	Hyb.
<b>Shore Power</b>	0.01	0.18	0.00	0.0009	0.0013	0.0012	0.0011	0.0017	0.0015	0.014	0.021	0.018
<b>Dock</b>	0.53	0.35	0.54	5.1	3.2	1.1	156	309	89	16	33	10
<b>Standby</b>	0.07	0.07	0.07	26.6	8.7	7.3	3757	832	677	176	83	68
<b>Transit</b>	0.16	0.18	0.17	114.8	16.9	15.5	7633	2683	2371	530	276	240
<b>Barge Move</b>	0.05	0.05	0.05	133.1	42.1	36.4	7666	5588	4659	555	569	457
<b>Ship Assist</b>	0.17	0.17	0.17	82.0	36.4	38.3	6452	4270	4541	424	423	450
<i>Overall Emissions Using Individual Wt. Factors</i>				44.1	13.2	12.1	3088	1676	1528	208	169	153
<b>% Reduction compared to Conventional Tug</b>					<b>70%</b>	<b>73%</b>		<b>46%</b>	<b>51%</b>		<b>19%</b>	<b>27%</b>
<i>Overall Emissions using Average Wt. Factors</i>				45.2	13.6	12.2	3153	1708	1523	213	173	152
<b>% Reduction compared to Conventional Tug</b>					<b>70%</b>	<b>73%</b>		<b>46%</b>	<b>52%</b>		<b>19%</b>	<b>29%</b>

*Wt. Factors*- Weighting Factors, *Con.*-Conventional Tug, *Hyb.*-Hybrid Tug, *Hyb\_NB*-Hybrid Tug without Batteries



**Figure 3-23** Overall Emission Reductions



Table 3-10 Modal and Overall Emissions Reductions with Hybrid Technology for Retrofit Scenario 1

Assumption: Both tugs have CAT 3512 C main engines and Cummins QSK11-M auxiliaries

Operating Mode	Operating Mode Weighting Factors			PM <sub>2.5</sub> (g/hr)			NO <sub>x</sub> (g/hr)			CO <sub>2</sub> (kg/hr)		
	Con.	Hyb.	Average	Con.	Hyb_NB	.Hyb	Con.	Hyb_NB	Hyb.	Con.	Hyb_NB	Hyb.
Shore Power	0.01	0.18	0	0.0009	0.0013	0.0012	0.0011	0.0017	0.0015	0.014	0.021	0.018
Dock	0.53	0.35	0.54	1.9	3.2	1.1	241	309	89	18	33	10
Standby	0.07	0.07	0.07	23.5	8.7	7.1	3842	1127	886	178	84	69
Transit	0.16	0.18	0.17	111.6	24.4	19.0	7718	3021	2679	531	270	235
Barge Move	0.05	0.05	0.05	130.0	75.7	55.3	7751	7289	6421	557	534	435
Ship Assist	0.17	0.17	0.17	78.8	59.8	60.4	6537	5934	6197	426	394	422
<i>Overall Emissions Using Individual Wt. Factors</i>				41.0	20.4	17.5	3172	2132	1976	210	162	146
<b>% Reduction compared to Conventional Tug</b>					<b>50%</b>	<b>57%</b>		<b>33%</b>	<b>38%</b>		<b>23%</b>	<b>31%</b>
<i>Overall Emissions using Average Wt. Factors</i>				42.1	20.7	17.6	3238	2160	1966	215	165	145
<b>% Reduction compared to Conventional Tug</b>					<b>51%</b>	<b>58%</b>		<b>33%</b>	<b>39%</b>		<b>23%</b>	<b>32%</b>

Wt. Factors- Weighting Factors, Con.-Conventional Tug, Hyb.-Hybrid Tug, Hyb\_NB-Hybrid Tug without Batteries

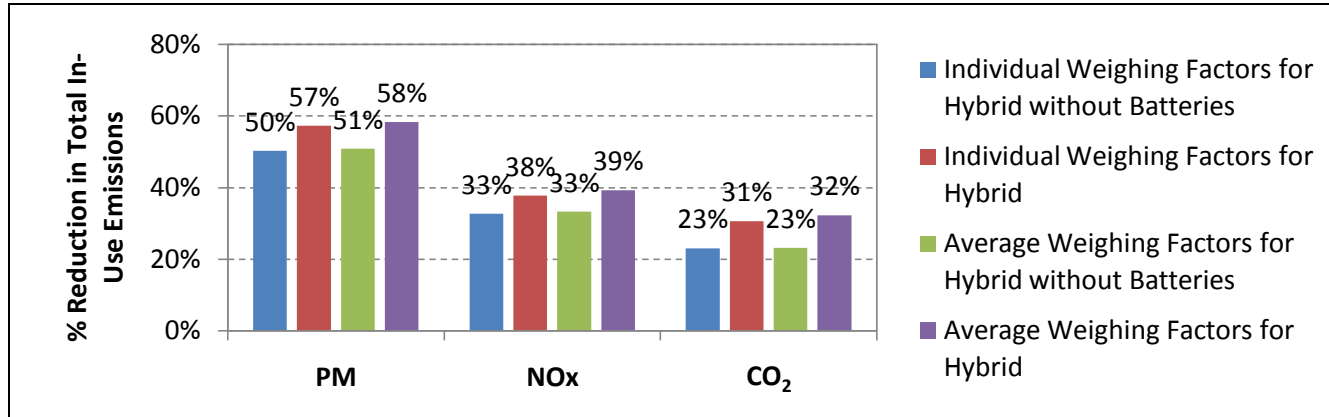


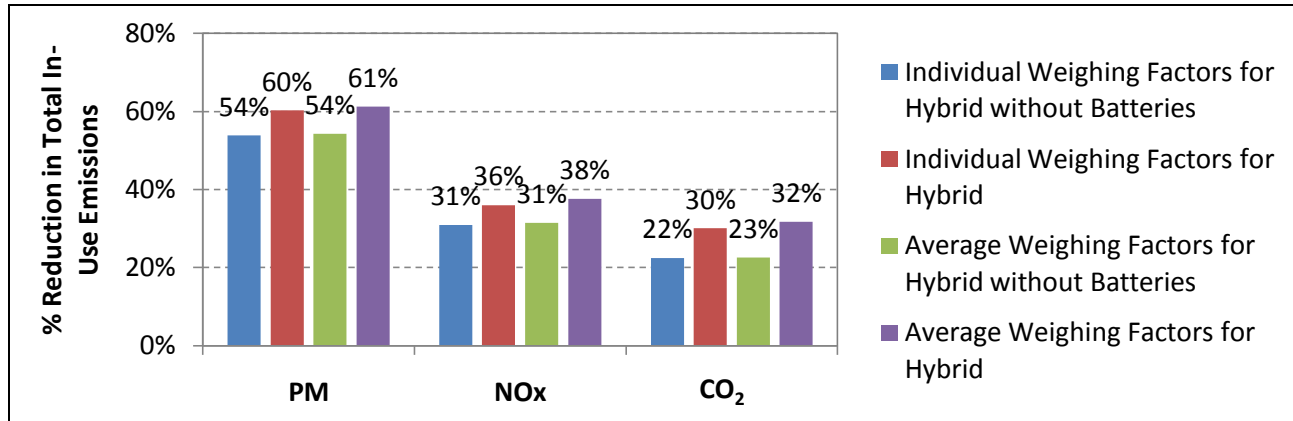
Figure 3-24 Overall Emission Reductions for Retrofit Scenario 1

**Table 3-11** Modal and Overall Emissions Reductions with Hybrid Technology for Retrofit Scenario 2

Assumption: Conventional tug has CAT 3512C mains and JD 6081 auxiliaries; hybrid tug has CAT 3512 C mains and Cummins QSK11-M auxiliaries

Operating Mode	Operating Mode Weighting Factors			PM <sub>2.5</sub> (g/hr)			NO <sub>x</sub> (g/hr)			CO <sub>2</sub> (kg/hr)		
	Con.	Hyb.	Average	Con.	Hyb_NB	Hyb.	Con.	Hyb_NB	Hyb.	Con.	Hyb_NB	Hyb.
<b>Shore Power</b>	0.01	0.18	0	0.0009	0.0013	0.0012	0.0011	0.0017	0.0015	0.014	0.021	0.018
<b>Dock</b>	0.53	0.35	0.54	5.1	3.2	1.1	156	309	89	16.0	32.8	9.9
<b>Standby</b>	0.07	0.07	0.07	27	9	7	3757	1127	886	176	84	69
<b>Transit</b>	0.16	0.18	0.17	115	24	19	7633	3021	2679	530	270	235
<b>Barge Move</b>	0.05	0.05	0.05	133	76	55	7666	7289	6421	555	534	435
<b>Ship Assist</b>	0.17	0.17	0.17	82	60	60	6452	5934	6197	424	394	422
<i>Overall Emissions Using Individual Wt. Factors</i>				44.1	20.4	17.5	3088	2132	1976	208	162	146
<b>% Reduction compared to Conventional Tug</b>					<b>54%</b>	<b>60%</b>		<b>31%</b>	<b>36%</b>		<b>22%</b>	<b>30%</b>
<i>Overall Emissions using Average Wt. Factors</i>				45.2	20.7	17.6	3153	2160	1966	213	165	145
<b>% Reduction compared to Conventional Tug</b>					<b>54%</b>	<b>61%</b>		<b>31%</b>	<b>38%</b>		<b>23%</b>	<b>32%</b>

Wt. Factors- Weighting Factors, Con.-Conventional Tug, Hyb.-Hybrid Tug, Hyb\_NB-Hybrid Tug without Batteries



**Figure 3-25** Overall Emission Reductions for Retrofit Scenario 2

## 4 Summary and Recommendations

The primary goal of this project was to develop and implement a test protocol to determine the emission benefits of a hybrid tug. For this purpose, a conventional and a hybrid tug built on the same classification were chosen. The conventional tug was powered by four diesel engines while the hybrid tug operated on four diesel engines and 126 batteries. All diesel engines were EPA Tier 2 certified.

The first step of the research involved the development of a data logging system capable of continuously logging the daily activity of all the power sources on each tug. This system was used to collect one month of activity data from each tug. Gigabytes of data were analyzed to establish weighing factor for different tug operating modes and develop engine histograms at each operating mode for all the eight engines.

The second step of the research was the implementation of a two phase emissions testing program to establish the emissions profile of the diesel engines across their entire operating range. Gaseous and PM<sub>2.5</sub> emissions were measured as per the ISO 8178-1 protocols. Several quality control checks such as fuel carbon to exhaust carbon balance, total PM<sub>2.5</sub> to speciated PM<sub>2.5</sub> mass balance, <2% standard deviation in CO<sub>2</sub> emission factors at each of the steady state test mode, comparison with manufacturer's reported numbers and reasonable error bars on the final readings showing good repeatability and reproducibility helped validate the emissions testing.

The final analysis combined engine histogram and emission profile data to determine in-use emissions at each tug operating mode for both conventional and the hybrid tug. These figures were coupled with the weighing factors for the operating modes to get the overall in-use emissions in g/hr for each tug. Significant emission benefits were observed for the hybrid technology. The reductions in the fuel equivalent CO<sub>2</sub> emissions were in good agreement with the fuel savings measured by the tugboat owner over an eight month period. This quality check increases the confidence in the test protocol and analysis techniques.

The major findings of this program include:

- Tug boats involved in this study operate in five different modes – dock, standby, transit, ship assist and barge moves. The average weighing factors for these operating modes were found to be 0.54, 0.07, 0.17, 0.17 and 0.05 respectively.
- The conventional tug tested in this program did not plug into shore power while the hybrid tug spent one-third of the time at dock plugged in.
- The average loads on the main and auxiliary engines of the conventional tug are 16% and 12% of the maximum load. For the hybrid tug average loads of main and auxiliary engines were found to be 12% and 34% of the rated power. These average operating loads are well below the load factors of the standard ISO duty cycles. This finding highlights the importance of developing of in-use duty cycles

that help predict the emissions at source more accurately thereby reducing the uncertainties in emission inventories.

- Four EPA Tier 2 certified in-use marine engines were tested following the load points in the standard ISO cycles. The overall weighted average NO<sub>x</sub> emission factors for these engines range from 7.1 to 7.8 g/kW-hr. These factors are just below (for CAT 3512 C) or greater than the EPA Tier 2 standard for the sum of NO<sub>x</sub> and total hydrocarbon (THC) emissions of 7.2 g/kW-hr. The weighted average PM<sub>2.5</sub> emission factors, for three out of the four engines, were well below the EPA Tier 2 standard of 0.20 g/kW-hr.
- Overall in-use emission reductions with the hybrid technology were found to be 73% for PM<sub>2.5</sub>, 51% for NO<sub>x</sub> and 27% for CO<sub>2</sub>.
- The diesel electric drive train on the hybrid tug that allows the use of auxiliary power for propulsion was the primary cause for the overall in-use emission reductions as opposed to the energy storage device (batteries).
- The transit operating mode was the most significant contributor to the overall emission reductions. In this mode the hybrid tug was powered by one or two auxiliary engines and batteries while the conventional tug used one auxiliary and two main engines.

#### Recommendations for further studies

- The hybrid tug can also be operated as a plug in hybrid. During this test program the tug could not be operated as a plug in hybrid due to lack of sufficient shore power. Future studies on the hybrid tug should involve tailoring the existing test protocol to determine the emission benefits of the plug in hybrid.
- Activity data from the hybrid tug operating without batteries was collected for a period of only 1.5 days. This data revealed that the primary cause of emission benefits of the hybrid tug was the diesel electric drive train and not the batteries. To increase the confidence in this conclusion activity data on the hybrid tug operating without batteries should be collected for a larger time period of approximately one month.

## References

1. Corbett, J. J.; Winebrake, J. J.; Green, E. H.; Kasibhatla, P.; Eyring, V.; Lauer, A., Mortality from ship emissions: A global assessment. *Environmental Science & Technology* **2007**, 41, (24), 8512-8518.
2. Deniz, C.; Durmusoglu, Y., Estimating shipping emissions in the region of the Sea of Marmara, Turkey. *Science of the Total Environment* **2008**, 390, (1), 255-261.
3. Lucialli, P.; Ugolini, P.; Pollini, E., Harbour of Ravenna: The contribution of harbour traffic to air quality. *Atmospheric Environment* **2007**, 41, (30), 6421-6431.
4. Saxe, H.; Larsen, T., Air pollution from ships in three Danish ports. *Atmospheric Environment* **2004**, 38, (24), 4057-4067.
5. Schrooten, L.; De Vlleger, I.; Panis, L. I.; Styns, K.; Torfs, R., Inventory and forecasting of maritime emissions in the Belgian sea territory, an activity-based emission model. *Atmospheric Environment* **2008**, 42, (4), 667-676.
6. Vutukuru, S.; Dabdub, D., Modeling the effects of ship emissions on coastal air quality: A case study of southern California. *Atmospheric Environment* **2008**, 42, (16), 3751-3764.
7. Starcrest Consulting LLC, Port of Long Beach Air Emissions Inventory - 2005. **2007**, Prepared for the Port of Long Beach.
8. Starcrest Consulting LLC, Port of Los Angeles Inventory of Air Emissions. **2009**, Prepared for the Port of Los Angeles.
9. Corbett, J. J.; Fischbeck, P. S., Emissions from Waterborne Commerce Vessels in United States Continental and Inland Waterways. *Environmental Science & Technology* **2000**, 34, (15), 3254-3260.
10. Corbett, J. J.; Robinson, A. L., Measurements of NO<sub>x</sub> Emissions and In-Service Duty Cycle from a Towboat Operating on the Inland River System. *Environmental Science & Technology* **2001**, 35, (7), 1343-1349.
11. U.S. Environmental Protection Agency, Final Rule: Control of Emissions of Air Pollution from Locomotives and Marine Compression-Ignition Engines Less Than 30 Liters per Cylinder. **2008**, 40 CFR, Parts 85-94.
12. Cooper, D. A., Exhaust emissions from high speed passenger ferries. *Atmospheric Environment* **2001**, 35, (24), 4189-4200.
13. Cooper, D. A.; Peterson, K.; Simpson, D., Hydrocarbon, PAH and PCB emissions from ferries: A case study in the Skagerak-Kattegatt-Öresund region. *Atmospheric Environment* **1996**, 30, (14), 2463-2473.
14. Society of Automotive Engineers, Recommended Practices for Measuring Exhaust Emissions and Fuel Economy of Hybrid Electric Vehicles. **1999**, SAE J1711.
15. California Air Resources Board, California Exhaust Emission Standards and Test Procedures for 2009 and Subsequent Model Zero-Emission Vehicles, and Hybrid Electric Vehicles, In the Passenger Car, Light-Duty Truck and Medium-Duty Vehicle Classes. **2009**.
16. International Organization for Standardization, ISO 8178-1 Reciprocating internal combustion engines - Exhaust emission measurement - Part 1: Test-bed

- measurement of gaseous and particulate exhaust emissions. **1996**, *First Edition*  
*1996-08-15*.
17. Environ International Corporation, Cold Ironing Cost Effectiveness Study. **2004**,  
*Prepared for Port of Long Beach*.
  18. U.S. Environmental Protection Agency, AP-42 Compilation of Air Pollutant  
Emission Factors. **2004**, *Fifth Edition Vol I*.

## **Appendix A - Measuring Gaseous & Particulate Emissions**

## A.1 Scope

ISO 8178-1<sup>1</sup> and ISO 8178-2<sup>2</sup>, when combined with engine load and speed duty cycles provided in ISO 8178-4, specify the measurement and evaluation methods for gaseous and particulate exhaust emissions. The emission results represent the mass rate of emissions per unit of work accomplished. Specific emission factors are based on brake power measured at the crankshaft, the engine being equipped only with the standard auxiliaries necessary for its operation. Per ISO, auxiliary losses are <5% of the maximum observed power.

IMO ship pollution rules and measurement methods are contained in the “International Convention on the Prevention of Pollution from Ships”, known as MARPOL 73/78<sup>3</sup>, and sets limits on NO<sub>x</sub> and SO<sub>x</sub> emissions from ship exhausts. The intent of this protocol was to conform as closely as practical to both the ISO and IMO standards.

## A.2 Sampling System for Measuring Gaseous and Particulate Emissions

A properly designed sampling system is essential for accurate collection of a representative sample from the exhaust and subsequent analysis. ISO points out that particulate must be collected in either a full flow or partial flow dilution system and UCR chose the partial flow dilution system with single venturi as shown in Figure A-1.

A partial flow dilution system was selected based on cost and the impossibility of a full flow dilution for “medium and large” engine testing on the test bed and at site. The flow in the dilution system eliminates water condensation in the dilution and sampling systems and maintains the temperature of the diluted exhaust gas at <52°C before the filters. ISO cautions the advantages of partial flow dilution systems can be lost to potential problems such as: losing particulates in the transfer tube, failing to take a representative sample from the engine exhaust and inaccurately determining the dilution ratio.

An overview of UCR’s partial dilution system shows that raw exhaust gas is transferred from the exhaust pipe (EP) through a sampling probe (SP) and the transfer tube (TT) to a dilution tunnel (DT) due to the negative pressure created by the venturi (VN) in DT. The gas flow rate through TT depends on the momentum exchange at the venturi zone and is therefore affected by the absolute temperature of the gas at the exit of TT. Consequently, the exhaust split for a given tunnel flow rate is not constant, and the dilution ratio at low load is slightly lower than at high load. More detail on the key components is provided in Table A-1.

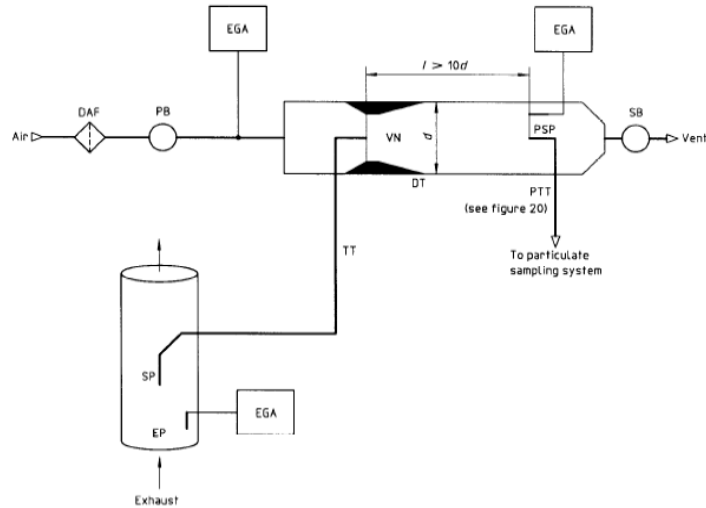
---

<sup>1</sup> International Standards Organization, ISO 8178-1, *Reciprocating internal combustion engines - Exhaust emission measurement -Part 1: Test-bed measurement of gaseous particulate exhaust emissions*, First edition 1996-08-15

<sup>2</sup> International Standards Organization, ISO 8178-2, *Reciprocating internal combustion engines - Exhaust emission measurement -Part 2: Measurement of gaseous and particulate exhaust emissions at site*, First edition 1996-08-15

<sup>3</sup> International Maritime Organization, *Annex VI of MARPOL 73/78 “Regulations for the Prevention of Air Pollution from Ships and NO<sub>x</sub> Technical Code”*.





**Figure A-1** Partial Flow Dilution System with Single Venturi, Concentration Measurement and Fractional Sampling

### A.3 Dilution Air System

A partial flow dilution system requires dilution air and UCR uses compressed air in the field as it is readily available. ISO recommends the dilution air be at  $25 \pm 5^\circ\text{C}$ , filtered and charcoal scrubbed to eliminate background hydrocarbons. The dilution air may be dehumidified. To ensure the compressed air is of a high quality UCR processes any supplied air through a field processing unit that reduces the pressure to about 30psig as that level allows a dilution ratio of about 5/1 in the geometry of our system. The next stages, in sequence, include: a liquid knock-out vessel, desiccant to remove moisture with silica gel containing an indicator, hydrocarbon removal with activated charcoal and a HEPA filter for the fine aerosols that might be present in the supply air. The silica gel and activated carbon are changed for each field campaign. Figure A-2 shows the field processing unit in its transport case. In the field the case is used as a framework for supporting the unit



**Figure A-2** Field Processing Unit for Purifying Dilution Air in Carrying Case

**Table A-1** Components of a Sampling System: ISO/IMO Criteria & UCR Design

<b>Section</b>	<b>Selected ISO and IMO Criteria</b>	<b>UCR Design</b>
Exhaust Pipe (EP)	In the sampling section, the gas velocity is > 10 m/s, except at idle, and bends are minimized to reduce inertial deposition of PM. Sample position is 6 pipe diameters of straight pipe upstream and 3 pipe diameters downstream of the probe.	UCR follows the ISO recommendation, as closely as practical.
Sampling Probe (SP)	The minimum inside diameter is 4 mm and the probe is an open tube facing upstream on the exhaust pipe centerline. No IMO code.	UCR uses a stainless steel tube with diameter of 8mm placed near the center line.
Transfer Tube (TT)	<ul style="list-style-type: none"> <li>• As short as possible and &lt; 5 m in length;</li> <li>• Equal to/greater than probe diameter &amp; &lt; 25 mm diameter;</li> <li>• TTs insulated. For TTs &gt; 1m, heat wall temperature to a minimum of 250°C or set for &lt; 5% thermophoretic losses of PM.</li> </ul>	UCR no longer uses a transfer tube.
Dilution Tunnel (DT)	<ul style="list-style-type: none"> <li>• shall be of a sufficient length to cause complete mixing of the exhaust and dilution air under turbulent flow conditions;</li> <li>• shall be at least 75 mm inside diameter (ID) for the fractional sampling type, constructed of stainless steel with a thickness of &gt; 1.5 mm.</li> </ul>	UCR uses fractional sampling; stainless steel tunnel has an ID of 50mm and thickness of 1.5mm.
Venturi (VN)	The pressure drop across the venturi in the DT creates suction at the exit of the transfer tube TT and gas flow rate through TT is basically proportional to the flow rate of the dilution air and pressure drop.	Venturi proprietary design provided by MAN B&W; provides turbulent mixing.
Exhaust Gas Analyzers (EGA)	One or several analyzers may be used to determine the concentrations. Calibration and accuracy for the analyzers are like those for measuring the gaseous emissions.	UCR uses a 5-gas analyzer meeting IMO/ISO specs

#### **A.4 Calculating the Dilution Ratio**

According to ISO 8178, “it is essential that the dilution ratio be determined very accurately” for a partial flow dilution system such as what UCR uses. The dilution ratio is simply calculated from measured gas concentrations of CO<sub>2</sub> and/or NO<sub>x</sub> in the raw exhaust gas, the diluted exhaust gas and the dilution air. UCR has found it useful to independently determine the dilution ratio from both CO<sub>2</sub> and NO<sub>x</sub> and compare the values to ensure that they are within ±10%. UCR’s experience indicates the independently determined dilution ratios are usually within 5%. At systematic deviations within this range, the measured dilution ratio can be corrected, using the calculated dilution ratio. According to ISO, dilution air is set to obtain a maximum filter face temperature of <52°C and the dilution ratio shall be > 4.

#### **A.5 Dilution System Integrity Check**

ISO describes the necessity of measuring all flows accurately with traceable methods and provides a path and metric to quantifying the leakage in the analyzer circuits. UCR has adopted the leakage test and its metrics as a check for the dilution system. According to ISO the maximum allowable leakage rate on the vacuum side shall be 0.5% of the in-use flow rate for the portion of the system being checked. Such a low leakage rate allows confidence in the integrity of the partial flow system and its dilution tunnel. Experience has taught UCR that the flow rate selected should be the lowest rate in the system under test.

#### **A.6 Measuring the Gaseous Emissions: CO, CO<sub>2</sub>, HC, NO<sub>x</sub>, O<sub>2</sub>, SO<sub>2</sub>**

Measurement of the concentration of the main gaseous constituents is one of the key activities in measuring emission factors. This section covers the ISO/IMO protocols and that used by UCR. For SO<sub>2</sub>, ISO recommends and UCR concurs that the concentration of SO<sub>2</sub> is calculated based on the fact that >95% of the fuel sulfur is converted to SO<sub>2</sub>.

##### **A.6.1 Measuring Gaseous Emissions: ISO & IMO Criteria**

ISO specifies that either one or two sampling probes located in close proximity in the raw gas can be used and the sample split for different analyzers. However, in no case can condensation of exhaust components, including water and sulfuric acid, occur at any point of the analytical system. ISO specifies the analytical instruments for determining the gaseous concentration in either raw or diluted exhaust gases.

- Heated flame ionization detector (HFID) for the measurement of hydrocarbons;
- Non-dispersive infrared analyzer (NDIR) for the measurement of carbon monoxide and carbon dioxide;
- Heated chemiluminescent detector (HCLD) or equivalent for measurement of nitrogen oxides;
- Paramagnetic detector (PMD) or equivalent for measurement of oxygen.

ISO states the range of the analyzers shall accurately cover the anticipated concentration of the gases and recorded values between 15% and 100% of full scale. A calibration curve with five points is specified. However, with modern electronic recording devices,

like a computer, ISO allows the range to be expanded with additional calibrations. ISO details instructions for establishing a calibration curve below 15%. In general, calibration curves must be  $< \pm 2\%$  of each calibration point and by  $< \pm 1\%$  of full scale zero.

ISO outlines their verification method. Each operating range is checked prior to analysis by using a zero gas and a span gas whose nominal value is more than 80% of full scale of the measuring range. If, for the two points considered, the value found does not differ by more than  $\pm 4\%$  of full scale from the declared reference value, the adjustment parameters may be modified. If  $> 4\%$ , a new calibration curve is needed.

ISO & IMO specify the operation of the HCLD. The efficiency of the converter used for the conversion of  $\text{NO}_2$  into  $\text{NO}$  is tested prior to each calibration of the  $\text{NO}_x$  analyzer. The efficiency of the converter shall be  $> 90\%$ , and  $> 95\%$  is strongly recommended.

ISO requires measurement of the effects from exhaust gases on the measured values of  $\text{CO}$ ,  $\text{CO}_2$ ,  $\text{NO}_x$ , and  $\text{O}_2$ . Interference can either be positive or negative. Positive interference occurs in NDIR and PMD instruments where the interfering gas gives rise to the same effect as the gas being measured, but to a lesser degree. Negative interference occurs in NDIR instruments due to the interfering gas broadening the absorption band of the measured gas, and in HCLD instruments due to the interfering gas quenching the radiation. Interference checks are recommended prior to an analyzer's initial use and after major service intervals.

### A.6.2 Measuring Gaseous Emissions: UCR Design

The concentrations of  $\text{CO}$ ,  $\text{CO}_2$ ,  $\text{NO}_x$  and  $\text{O}_2$  in the raw exhaust and in the dilution tunnel are measured with a Horiba PG-250 portable multi-gas analyzer. The PG-250 simultaneously measures five separate gas components with methods recommended by the ISO/IMO and U.S. EPA. The signal output of the instrument is connected to a laptop computer through an RS-232 interface to continuously record measured values. Major features include a built-in sample conditioning system with sample pump, filters, and a thermoelectric cooler. The performance of the PG-250 was tested and verified under the U.S. EPA ETV program.



**Figure A-3** Setup Showing Gas Analyzer with Computer for Continuous Data Logging

Details of the gases and the ranges for the Horiba instrument are shown in Table A-2. Note that the Horiba instrument measures sulfur oxides (SO<sub>2</sub>); however, the UCR follows the protocol in ISO and calculates the SO<sub>2</sub> level from the sulfur content of the fuel as the direct measurement for SO<sub>2</sub> is less precise than calculation.

**Table A-2** Detector Method and Concentration Ranges for Monitor

<b>Component</b>	<b>Detector</b>	<b>Ranges</b>
<b>Nitrogen Oxides (NO<sub>x</sub>)</b>	Heated Chemiluminescence Detector (HCLD)	0-25, 50, 100, 250, 500, 1000, & 2500 ppmv
<b>Carbon Monoxide (CO)</b>	Non dispersive Infrared Absorption (NDIR)	0-200, 500, 1000, 2000, & 5000 ppmv
<b>Carbon Dioxide (CO<sub>2</sub>)</b>	Non dispersive Infrared Absorption (NDIR)	0-5, 10, & 20 vol%
<b>Sulfur Dioxide (SO<sub>2</sub>)</b>	Non dispersive Infrared Absorption (NDIR)	0-200, 500, 1000, & 3000 ppmv
<b>Oxygen</b>	Zirconium oxide sensor	0-5, 10, & 25 vol%

For quality control, UCR carries out analyzer checks with calibration gases both before and after each test to check for drift. Because the instrument measures the concentration of five gases, the calibration gases are a blend of several gases (super-blend) made to within 1% specifications. Experience has shown that the drift is within manufacturer specifications of ±1% full scale per day shown in Table A-3. The PG-250 meets the analyzer specifications in ISO 8178-1 Section 7.4 for repeatability, accuracy, noise, span drift, zero drift and gas drying.

**Table A-3** Quality Specifications for the Horiba PG-250

<b>Repeatability</b>	±0.5% F.S. (NO <sub>x</sub> : ≤ 100ppm range CO: ≤ 1,000ppm range) ±1.0% F. S.
<b>Linearity</b>	±2.0% F.S.
<b>Drift</b>	±1.0% F. S./day (SO <sub>2</sub> : ±2.0% F.S./day)

## A.7 Measuring the Particulate Matter (PM) Emissions

ISO 8178-1 defines particulates as any material collected on a specified filter medium after diluting exhaust gases with clean, filtered air at a temperature of  $\leq 52^{\circ}\text{C}$ , as measured at a point immediately upstream of the primary filter. The particulate consists of primarily carbon, condensed hydrocarbons and sulfates, and associated water. Measuring particulates requires a dilution system and UCR selected a partial flow dilution system. The dilution system design completely eliminates water condensation in the dilution/sampling systems and maintains the temperature of the diluted exhaust gas at  $\leq 52^{\circ}\text{C}$  immediately upstream of the filter holders. IMO does not offer a protocol for measuring PM. A comparison of the ISO and UCR practices for sampling PM is shown in Table A-4.

**Table A-4** Measuring Particulate by ISO and UCR Methods

	<b>ISO</b>	<b>UCR</b>
Dilution tunnel	Either full or partial flow	Partial flow
Tunnel & sampling system	Electrically conductive	Same
Pretreatment	None	Cyclone, removes $>2.5\mu\text{m}$
Filter material	Fluorocarbon based	Teflon (TFE)
Filter size, mm	47 (37mm stain diameter)	Same
Number of filters in series	Two	One
Number of filters in parallel	Only single filter	Two; 1 Teflo <sup>®</sup> & 1 Tissuauartz
Number of filters per mode	Single or multiple	Multiple
Filter face temp. $^{\circ}\text{C}$	$< 52$	Same
Filter face velocity, cm/sec	35 to 80.	$\sim 33$
Pressure drop, kPa	For test $<25$	Same
Filter loading, $\mu\text{g}$	$>500$	500-1,000 + water w/sulfate
Weighing chamber	$22\pm 3^{\circ}\text{C}$ & $\text{RH} = 45\% \pm 8$	Same
Analytical balance, LDL $\mu\text{g}$	10	0.5
Flow measurement	Traceable method	Same
Flow calibration, months	$< 3$ months	Every campaign

**Sulfur content:** According to ISO, particulates measured using ISO 8178 are “conclusively proven” to be effective for fuel sulfur levels up to 0.8%. UCR is often faced with measuring PM for fuels with sulfur content exceeding 0.8% and has extended this method to those fuels as no other method is prescribed for fuels with a higher sulfur content.

### A.7.1 Added Comments about UCR’s Measurement of PM

In the field UCR uses a raw particulate sampling probe fitted close to and upstream of the raw gaseous sample probe and directs the PM sample to the dilution tunnel. There are two gases stream leaving the dilution tunnel; the major flow vented outside the tunnel and the minor flow directed to a cyclone separator, sized to remove particles  $>2.5\mu\text{m}$ . The line leaving the cyclone separator is split into two lines; each line has a 47 Gelman filter holder. One holder collects PM on a Teflo<sup>®</sup> filter and the other collects PM on a Tissuquartz filter. UCR simultaneously collects PM on Teflo<sup>®</sup> and Tissuquartz filters at each operating mode and analyzes them according to standard procedures.

Briefly, PM mass collected on the Pall Gelman (Ann Arbor, MI) 47 mm Teflo<sup>®</sup> filters was determined by the difference in weight of the filter before and after sample collection. These filters were conditioned for 24 hours in an environmentally controlled room (RH = 40%, T= 25°C) and weighed daily, using a Mettler Toledo UMX2 microbalance, until two consecutive weight measurements were within 3µg or 2%.

The 47mm 2500 QAT-UP Tissuquartz filters (Pall, Ann Arbor, MI) were preconditioned for 5 hours at 600°C and stored at temperatures <4°C before and after sampling and analysis. EC/OC analysis on the Tissuquartz filters was performed according to the NIOSH method<sup>1</sup> using Sunset Laboratories Thermal/Optical Carbon Aerosol Analyzer.

It is important to note that the simultaneous collection of PM on Tissuquartz and Teflo<sup>®</sup> filters provides a comparative check of PM mass measured by two independent methods and serves as an important quality check for measuring PM mass.

## **A.8 Measuring Real-Time Particulate Matter (PM) Emissions- DustTrak**

In addition to the filter-based PM mass measurements, UCR takes continuous readings with a Nephelometer (TSI DustTrak 8520) so as to capture both the steady-state and transient data. The Dust Trak is a portable, battery-operated laser photometer that gives real-time digital readout with the added benefits of a built-in data logger. The DustTrak nephelometer is fairly simple to use and has excellent sensitivity to untreated diesel exhaust. It measures light scattered by aerosol introduced into a sample chamber and displays the measured mass density as units of mg/m<sup>3</sup>. As scattering per unit mass is a strong function of particle size and refractive index of the particle size distributions and as refractive indices in diesel exhaust strongly depend on the particular engine and operating condition, some scientists question the accuracy of these PM mass measurements. However, UCR always references the DustTrak results to filter based measurements and this approach has shown that mass scattering efficiencies for both on-road diesel exhaust and ambient fine particles have values around 3m<sup>2</sup>/g. For these projects, a TSI DustTrak 8520 nephelometer measuring 90° light scattering at 780nm (near-infrared) is used.



**Figure A-4** Picture of TSI DustTrak

<sup>1</sup> NIOSH Manual of Analytical Methods National Institute of Occupational Safety and Health, Cincinnati, OH; 1996.

## **A.9 Quality Control/Quality Assurance (QC/QA)**

Each of the laboratory methods for PM mass and chemical analysis has a standard operating procedure including the frequency of running standards and the repeatability that is expected with a standard run. Additionally the data for the standards are plotted to ensure that the values fall within the upper and lower control limits for the method and that there is no obvious trends or bias in the results for the reference materials. As an additional quality check, results from independent methods are compared and values from this work are compared with previously published values, like the manufacturer data base.

- For the ISO cycles, run the engine at rated speed and the highest power possible to warm the engine and stabilize emissions for about 30 minutes.
- Determine a plot or map of the peak power at each engine speed (rpm), starting with rated speed. If UCR suspects the 100% load point at rated speed is unattainable, then we select the highest possible load on the engine as Mode 1.
- Emissions are measured while the engine operates according to the requirements of ISO-8178-E3 or ISO-8178-D2 cycles. For a diesel engine the highest power mode is run first and then each mode was run in sequence. The minimum time for samples is 5 minutes and if necessary, the time was extended to collect sufficient particulate sample mass or to achieve stabilization with large engines.
- The gaseous exhaust emission concentration values are measured and recorded for the last 3 min of the mode.
- Engine speed, displacement, boost pressure, and intake manifold temperature are measured in order to calculate the gaseous flow rate.
- Emissions factors are calculated in terms of grams per kilowatt hour for each of the operating modes and fuels tested, allowing for emissions comparisons of each blend relative to the baseline fuel.



## **Appendix B - Test Cycles and Fuels for Different Engine Applications**

## B.1 Introduction

Engines for off-road use are made in a much wider range of power output and used in a more applications than engines for on-road use. The objective of ISO 8178-4<sup>1</sup> is provide the minimum number of test cycles by grouping applications with similar engine operating characteristics. ISO 8178-4 specifies the test cycles while measuring the gaseous and particulate exhaust emissions from reciprocating internal combustion engines coupled to a dynamometer or at the site. The tests are carried out under steady-state operation using test cycles which are representative of given applications.

**Table B-1** Definitions Used Throughout ISO 8178-4

<b>Test cycle</b>	A sequence of engine test modes each with defined speed, torque and weighting factor, where the weighting factors only apply if the test results are expressed in g/kWh.
<b>Preconditioning the engine</b>	1) Warming the engine at the rated power to stabilize the engine parameters and protect the measurement against deposits in the exhaust system. 2) Period between test modes which has been included to minimize point-to-point influences.
<b>Mode</b>	An engine operating point characterized by a speed and a torque.
<b>Mode length</b>	The time between leaving the speed and/or torque of the previous mode or the preconditioning phase and the beginning of the following mode. It includes the time during which speed and/or torque are changed and the stabilization at the beginning of each mode.
<b>Rated speed</b>	Speed declared by engine manufacturer where the rated power is delivered.
<b>Intermediate speed</b>	Speed declared by the manufacturer, taking into account the requirements of ISO 8178-4 clause 6.

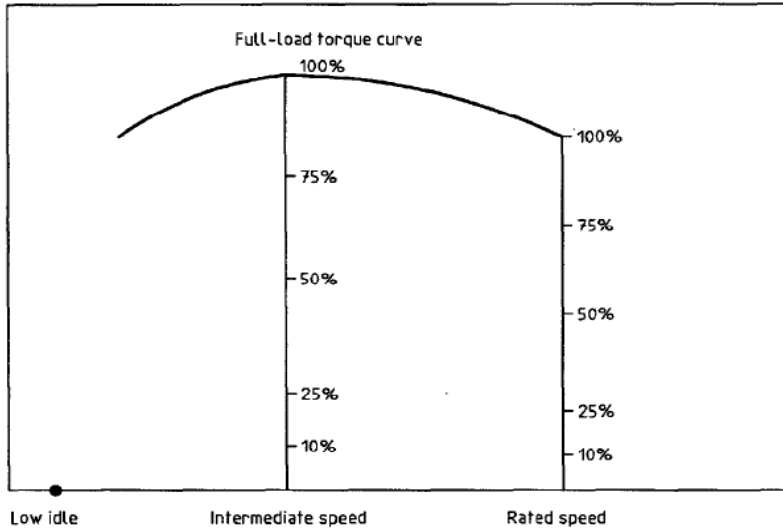
### B.1.1 Intermediate speed

For engines designed to operate over a speed range on a full-load torque curve, the intermediate speed shall be the maximum torque speed if it occurs between 60% and 75% of rated speed. If the maximum torque speed is less than 60% of rated speed, then the intermediate speed shall be 60% of the rated speed. If the maximum torque speed is greater than 75% of the rated speed then the intermediate speed shall be 75% of rated speed.

The intermediate speed will typically be between 60% and 70% of the maximum rated speed for engines not designed to operate over a speed range on the full-load torque curve at steady state conditions. Intermediate speeds for engines used to propel vessels with a fixed propeller are defined based on that application.

---

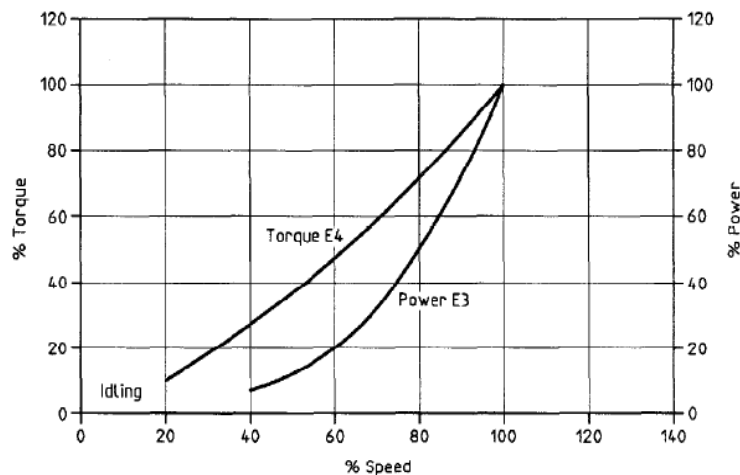
<sup>1</sup>International Standards Organization, ISO 8178-4, *Reciprocating internal combustion engines - Exhaust emission measurement - Part 4: Test cycles for different engine applications*, First edition ISO 8178-4:1996(E)



**Figure B-1** Torque as a Function of Engine Speed

## B.2 Engine Torque Curves and Test Cycles

The percentage of torque figures given in the test cycles and Figure B-1 represent the ratio of the required torque to the maximum possible torque at the test speed. For marine test cycle E3, the power figures are percentage values of the maximum rated power at the rated speed as this cycle is based on a theoretical propeller characteristic curve for vessels driven by heavy duty engines. For marine test cycle E4 the torque figures are percentage values of the torque at rated power based on the theoretical propeller characteristic curve representing typical pleasure craft spark ignited engine operation. For marine cycle E5 the power figures are percentage values of the maximum rated power at the rated speed based on a theoretical propeller curve for vessels of less than 24 m in length driven by diesel engines. Figure B-2 shows the two representative curves.



**Figure B-2** Examples of Power Scales

## B.3 Modes and Weighting Factors for Test Cycles

Most test cycles were derived from the 13-mode steady state test cycle (UN-ECE R49). Apart from the test modes of cycles E3, E4 and E5, which are calculated from propeller

curves, the test modes of the other cycles can be combined into a universal cycle (B) with emissions values calculated using the appropriate weighting factors. Each test shall be performed in the given sequence with a minimum test mode length of 10 minutes or enough to collect sufficient particulate sample mass. The mode length shall be recorded and reported and the gaseous exhaust emission concentration values shall be measured and recorded for the last 3 min of the mode. The completion of particulate sampling ends with the completion of the gaseous emission measurement and shall not commence before engine stabilization, as defined by the manufacturer.

**Table B-2** Combined Table of Modes and Weighting Factors

<b>B-Type mode number</b>	1	2	3	4	5	6	7	8	9	10	11
<b>Torque</b>	100	75	50	25	10	100	75	50	25	10	0
<b>Speed</b>	Rated speed					Intermediate speed					Low idle
<b>Off-road vehicles</b>											
Cycle C1	0,15	0,15	0,15		0,1	0,1	0,1	0,1			0,15
Cycle C2				0,06		0,02	0,05	0,32	0,3	0,1	0,15
<b>Constant speed</b>											
Cycle D1	0,3	0,5	0,2								
Cycle D2	0,05	0,25	0,3	0,3	0,1						
<b>Locomotives</b>											
Cycle F	0,25							0,15			0,6
<b>Utility, lawn and garden</b>											
Cycle G1						0,09	0,2	0,29	0,3	0,07	0,05
Cycle G2	0,09	0,2	0,29	0,3	0,07						0,05
Cycle G3	0,9										0,1
<b>Marine application</b>											
Cycle E1	0,08	0,11					0,19	0,32			0,3
Cycle E2	0,2	0,5	0,15	0,15							
<b>Marine application propeller law</b>											
<b>Mode number E3</b>	<b>1</b>					<b>2</b>		<b>3</b>		<b>4</b>	
<b>Power (%)</b>	100					75		50		25	
<b>Speed (%)</b>	100					91		80		63	
<b>Weighting factor</b>	0,2					0,5		0,15		0,15	
<b>Mode number E4</b>	<b>1</b>					<b>2</b>		<b>3</b>		<b>4</b>	
<b>Speed (%)</b>	100					80		60		40	
<b>Torque (%)</b>	100					71,6		46,5		25,3	
<b>Weighting factor</b>	0,06					0,14		0,15		0,25	
<b>Mode number E5</b>	<b>1</b>					<b>2</b>		<b>3</b>		<b>4</b>	
<b>Power (%)</b>	100					75		50		25	
<b>Speed (%)</b>	100					91		80		63	
<b>Weighting factor</b>	0,08					0,13		0,17		0,32	

## **Appendix C - Tug Boat Specifications**

# C.1 Conventional Tug



## VESSEL INFORMATION SHEET

VESSEL NAME:	ALTA JUNE
OFFICIAL #:	1211684
LR / IMO #:	
ABS #:	ACTNUM:

### REGULATORY

ABS LL: Y COASTWISE: Y  
 ABS CL: Y TITLE XI:  
 USCG INSP: Y CCF:  
 REGISTRY: Y SOLAS: N

### VESSEL DESCRIPTION

VSL TYPE: Dolphin Class  
 SERVICE: Harbor  
 CALLSIGN: WDE5645  
 HAIL. PORT: San Francisco, CA  
 OLD NAMES:  
 DATE BUILT: 2008 May  
 REBUILT:  
 BUILDER: Foss Maritime, Ranier, OR

### DIMENSIONS

REGISTER. GT: 144 REG. LENGTH: 78.0'  
 REGISTER. NT: 98 REG. BREADTH: 34.0'  
 ITC GR TONS: REG. DEPTH: 14.0'  
 ITC NT TONS: LOA: 78'  
 REGULAT. GT: 144 MAX BRDTH: 0  
 REGULAT. NT: 98 MIN HEIGHT: 0  
 DRAFT MIN: 0 MAX HEIGHT: 0  
 DRAFT MAX: 15'0" DISPLACEMNT: 0

### TANKS [ # / TOTAL CAPACITY ]

FUEL: 10,000 gl LUBE:  
 HYDRAULIC: WATER: 500 gl  
 FOAM:  
 BALLAST:

### MACHINERY

CONFIG: Twin Engine, ASD Propulsion  
 ME [#, TYPE]: Caterpillar 35, 12C HD Series II  
 RED. GEAR:  
 PROPELLER: 2 US 205 FP Rolls Royce ASD  
 TAILSHAFT(S):  
 ME COOLING:  
 MAX ME RPM: 0 SHAFT RPM:  
 RATED HP: 5,580 ESCORT HP:  
 CBHP: CSHP:  
 IBHP: ISHP:  
 BOLLPULL: 134,000 REVERSE: 129,620  
 AUX #1: John Deere 6081 Marrathon 125 kw  
 AUX #2: John Deere 6081 Marrathon 125 kw  
 AUX #3:

### CREWING REQUIREMENTS

FULL CREW: OCEAN CREW: SHORT CREW:

### ENGINE ROOM EQUIPMENT

MSD:  
 FIRE PUMP:  
 HOSE CONN:  
 MONITOR:  
 FIXED SYS:  
 FUEL TRAN:  
 STEERING:

### DECK GEAR

ANCH GEAR: N/A  
 BOW WINCH: Markey DEPGF-42 Electric  
 BOW WIRE: 500'x8-1/2" plasma 12x12 + 70'x15" poly stretc  
 TOW WINCH: Markey DEPC-32 (stern barge=handling winch)  
 TOW WIRE: 300' x 6-1/2" Amsteel Blue  
 TOW WIRE #2:  
 DECK CRANE:  
 DK CRANE #2: NA  
 UNDERRIDER:  
 STERN LINE:  
 WORK BOAT:

### ELECTRONICS

AUTO PILOT: Simrad Ap50  
 GYRO COMP:  
 RADAR #1: Furuno - Navanet  
 RADAR #2: Furuno - RDP-150  
 RADAR #3:  
 LORAN #1:  
 LORAN #2:  
 SAT NAV #1:  
 SAT NAV #2:  
 WEATHER FAX:  
 FATHOMETER: Furuno  
 FATHOM #2:  
 VHF #1: Sea-157  
 VHF #2: Sea-157  
 VHF #3: Sea-157  
 PORTABLE VHF: 2 ea. Standard Horizon  
 UHF/PRIVACY:  
 CITIZEN BAND:  
 SSB #1:  
 SSB #2:  
 CELLULAR: Y  
 MARINE RADIO:  
 ALARM PANEL: Y  
 LOUD HAILER: Y  
 FACSIMILE:  
 SOUND PHONE: Y  
 INTERCOM: Y  
 MAG COMPASS: Y  
 GPS: Nav-Net - Furuno  
 DIRECT FIND:  
 EPIRB: ADCD02271D43801

## C.2 Hybrid Tug



### VESSEL INFORMATION SHEET

VESSEL NAME:	CAROLYN DOROTHY
OFFICIAL #:	1216669
LR / IMO #:	
ABS #:	ACTNUM:

#### REGULATORY

ABS LL: Y COASTWISE: Y  
 ABS CL: Y TITLE XI:  
 USCG INSP: Y CCF:  
 REGISTRY: Y SOLAS: N

#### VESSEL DESCRIPTION

VSL TYPE: Diesel Electric Hybrid Z Drive  
 SERVICE: Los Angeles, Long Beach Harbor  
 CALLSIGN: WDE6786  
 HAIL PORT: LONG BEACH, CA  
 OLD NAMES:  
 DATE BUILT: Keel la Deliv  
 REBUILT:  
 BUILDER: Ranier S/Y, Ranier, OR

#### DIMENSIONS

REGISTER. GT: 144 REG. LENGTH: 78'  
 REGISTER. NT: 98 REG. BREADTH: 34'  
 ITC GR TONS: REG. DEPTH: 14'  
 ITC NT TONS: LOA:  
 REGULAT. GT: MAX BRDTH:  
 REGULAT. NT: MIN HEIGHT:  
 DRAFT MIN: MAX HEIGHT:  
 DRAFT MAX: DISPLACEMNT:

#### TANKS [ # / TOTAL CAPACITY]

FUEL: 9,500 gal LUBE:  
 HYDRAULIC: WATER: 500 gal  
 FOAM:  
 BALLAST:

#### MACHINERY

CONFIG:  
 ME [# , TYPE]: 2 Cummins QSK50 Tier 2  
 RED. GEAR:  
 PROPELLER: 2 Rolls Royce US205 Azimuthing Stern Drives  
 TAILSHAFT(S):  
 ME COOLING:  
 MAX ME RPM: 0 SHAFT RPM:  
 RATED HP: 5,000 ESCORT HP:  
 CBHP: CSHP:  
 IBHP: ISHP:  
 BOLLPULL: 124,000 REVERSE: 122,000  
 AUX #1: Siemens Motor-Generators  
 Cummins QSM11 Diesel Generators  
 AUX #2: Siemens Motor-Generators  
 Cummins QSM11 Diesel Generators  
 AUX #3: Gel Lead Acid Battery Pack

#### CREWING REQUIREMENTS

FULL CREW: 4 OCEAN CREW: SHORT CREW:

#### ENGINE ROOM EQUIPMENT

MSD:  
 FIRE PUMP:  
 HOSE CONN:  
 MONITOR:  
 FIXED SYS:  
 FUEL TRAN:  
 STEERING:

#### DECK GEAR

ANCH GEAR: Y  
 BOW WINCH: Markey DEPGF-42  
 BOW WIRE: 500'x8-1/2" Plasma + 70'x15" poly stretcher  
 TOW WINCH: Markey  
 TOW WIRE: 300' x 6-1/2" Amsteel  
 TOW WIRE #2:  
 DECK CRANE:  
 DK CRANE #2:  
 UNDERRIDER:  
 STERN LINE:  
 WORK BOAT:

#### ELECTRONICS

AUTO PILOT: Simrad AP50  
 GYRO COMP:  
 RADAR #1: Furuno Nav-Net  
 RADAR #2: Furuno RDP-150  
 RADAR #3:  
 LORAN #1:  
 LORAN #2:  
 SAT NAV #1: Com Nav G2  
 SAT NAV #2:  
 WEATHER FAX:  
 FATHOMETER: Y  
 FATHOM #2:  
 VHF #1: Sea 157  
 VHF #2: Sea 157  
 VHF #3: Sea 157  
 PORTABLE VHF: 2 ea. Standards  
 UHF/PRIVACY:  
 CITIZEN BAND:  
 SSB #1:  
 SSB #2:  
 CELLULAR: Y  
 MARINE RADIO:  
 ALARM PANEL:  
 LOUD HAILER: Y  
 FACSIMILE:  
 SOUND PHONE: Y  
 INTERCOM: Y  
 MAG COMPASS: Y  
 GPS: Nav-Net  
 DIRECT FIND:  
 EPIRB: ADCD020DC943C01

**REMARKS:** Dolphin #10, Hul #011. Robet Allen Ltd and Foss Maritime design. Other specs - SES power sotrage batteries (126), Aspin Kemp & assoc power integration system

## **Appendix D – Engine Specifications from Manufacturers**



## D.1 Main Engine on Conventional Tug

Certify Rerate

**EMISSIONS DATA [TTG00206]**

**DECEMBER 02, 2009**  
For Help Desk Phone Numbers

<b>Engine Emissions Data</b>	
For Emissions feedback and questions contact:	
1-800-447-2639	
This emission data is Caterpillar's best estimate for this rating. If actual emissions are required then an emission test needs to be run on your engine.	
Serial Number (Machine)	
Serial Number (Engine)	TTG00206
Sales Model	3512
Build Date	2007-06-05
Interlock Code Progression	No Interlock Code Progression
<b>As Shipped Data</b>	
Engine Arrangement Number	2824172
Certification Arrangement	
Certification Arrangement	
Certification Arrangement	
Certification Arrangement	
Test Spec Number	0K8034
Certification	Marine EU Inland Waterway
Certification	MARINE EPA-TIER 2
Certification	IMO Compliant with EPA Statement
Certification	IMO Tech File - Electronic Engines
Labeled Model Year	
Family Code	
Flash File	3129042
Flash File Progression	3129042
CORR FL Power at RPM	2,551 HP (1,902.0 KW ) at 1,800 rpms
Advertised Power	2,551hp 1,800RPM
Liters	3,574CU IN
This is not an official emission certificate. This is for emission data information only.	
Caterpillar Confidential: Green Content Owner: Shane Gilles Web Master(s): Current Date: Wednesday, December 02, 2009 1:07:08 PM	

<http://tmiweb.cat.com/tmi/server/TMIDirector?Action=buildtab&refkind=RNTMRefNum&tab=C> 12/02/2009

**PERFORMANCE DATA [TTG00206]**

**DECEMBER 02, 2009**  
For Help Desk Phone Numbers

Perf No: DM9246

Change Level: 02

General

SALES MODEL:	3512C	COMBUSTION:	DI
ENGINE POWER (BHP):	2,950	ENGINE SPEED (RPM):	1,300
PEAK TORQUE (FT-LB):	6,850.7	PEAK TORQUE SPEED (RPM):	1,300
COMPRESSION RATIO:	14.7	ASPIRATION:	TA
APPLICATION:	MARINE PROPULSION	AFTERCOOLER TYPE:	SCAC
RATING LEVEL:	D-RATING (INTERMITTENT DUTY)	AFTERCOOLER CIRCUIT TYPE:	1W-DC, AC
PUMP QUANTITY:	2	AFTERCOOLER TEMP (F):	108
FUEL TYPE:	DIESEL	JACKET WATER TEMP (F):	110.2
MANIFOLD TYPE:	DRY	TURBO CONFIGURATION:	PARALLEL
GOVERNOR TYPE:	ADEM3	TURBO QUANTITY:	2
ELECTRONICS TYPE:	ADEM3	TURBOCHARGER MODEL:	STB6061BLN-48T-1.47
IGNITION TYPE:	CI	CERTIFICATION YEAR:	2007
INJECTOR TYPE:	EUI	CRANKCASE BLOWBY RATE (FT3/HR):	2,547.7
FUEL INJECTOR:	2481079	FUEL RATE (RATED RPM) NO LOAD (GAL/MIN):	9.5
REF EXH STACK DIAMETER (IN):	10	PISTON SPD @ RATED ENG SPD (FT/MIN):	2,539.4
MAX OPERATING ALTITUDE (FT):	2,297		

**General Performance Data**

**ZONE 1**

ENGINE SPEED	ENGINE POWER	ENGINE TORQUE	BRAKE MEAN EFF PRES (BMEP)	BRAKE SPEC FUEL CONSUMPTN (BSFC)	VOL FUEL CONSUMPTN (VFC)	INLET MFLD PRES	INLET MFLD TEMP	EXH MFLD TEMP	EXH MFLD PRES	EXH STACK TEMP
RPM	BHP	LB-FT	PSI	LB/BHP-HR	GAL/HR	IN-HG	DEG F	DEG F	IN-HG	DEG F
1,900	1,911	5,576	285	0.342	93.4	71.7	119.0	1,005.6	56.0	575.6
1,700	1,911	5,904	249	0.331	90.3	68.4	119.0	1,016.7	51.0	594.6
1,600	1,911	6,273	265	0.327	89.3	67.4	118.9	1,029.8	48.3	720.5
1,500	1,899	6,648	261	0.320	86.7	63.2	118.0	1,070.5	42.8	762.7
1,400	1,797	5,740	284	0.318	81.5	55.7	116.8	1,127.5	35.4	835.0
1,300	1,100	4,446	188	0.331	52.0	24.9	115.5	1,156.1	17.0	945.0
1,200	955	3,748	159	0.337	41.2	15.0	115.0	1,182.0	11.0	992.7
1,100	636	3,038	118	0.364	31.2	8.4	116.7	1,061.2	8.0	946.5
1,000	551	2,892	122	0.345	27.2	6.1	119.0	1,065.2	6.5	940.8
900	406	2,838	120	0.347	24.1	4.6	119.4	1,054.7	5.3	937.6
800	429	2,818	119	0.350	21.4	3.5	121.0	1,044.5	4.5	919.2
700	374	2,306	118	0.355	19.0	2.7	122.6	1,023.1	4.0	883.5

**ZONE 1**

ENGINE SPEED	ENGINE POWER	COMPRESSOR OUTLET PRES	COMPRESSOR OUTLET TEMP	WET INLET AIR VOL FLOW RATE	WET EXH GAS VOL FLOW RATE	WET INLET AIR MASS FLOW RATE	WET EXH GAS MASS FLOW RATE	WET EXH VOL FLOW RATE (32 DEG F AND 30.08 IN HG)	DRY EXH VOL FLOW RATE (32 DEG F AND 29.92 IN HG)
RPM	BHP	IN-HG	DEG F	CFM	CFM	LB/HR	LB/HR	FT3/MIN	FT3/MIN

<http://tmiweb.cat.com/tmi/servlet/TMIDirector?Action=buildtab&refkind=RNTMRefNum&tab=M...> 12/02/2009

MAX Performance Data Display

1,800	1,911	74	182.2	5,360.2	11,489.4	22,035.6	27,844.0	4,471.0	4,879.2
1,700	1,911	71	167.6	4,929.3	10,791.6	21,214.5	21,347.6	4,558.8	4,830.1
1,600	1,911	69	159.9	4,684.0	10,467.8	20,388.2	20,594.7	4,761.1	4,690.7
1,500	1,999	65	146.9	4,246.9	9,840.9	18,227.7	18,933.9	4,958.1	4,601.3
1,400	1,797	57	128.4	3,620.5	8,948.3	15,573.8	16,144.5	4,398.0	3,147.9
1,300	1,100	26	217.6	1,122.7	5,682.4	9,104.5	9,474.5	1,988.3	1,828.1
1,200	856	16	170.9	1,524.7	4,479.6	6,923.6	7,212.3	1,816.8	1,891.5
1,100	635	9	135.2	1,245.5	3,309.2	5,279.5	5,498.0	1,157.1	1,062.2
1,000	551	5	121.9	1,071.5	2,824.5	4,529.8	4,719.9	991.6	909.2
900	485	5	113.3	929.5	2,449.2	3,925.5	4,094.0	661.5	789.9
800	429	4	107.3	802.0	2,091.8	3,383.3	3,533.1	745.5	691.0
700	374	3	103.1	697.0	1,739.7	2,886.3	3,028.2	635.8	579.8

ZONE 1-2

ENGINE SPEED	ENGINE POWER	ENGINE TORQUE	BRAKE MEAN EFF PRESS (BMEP)	BRAKE SPEC FUEL CONSUMPTN (BSFC)	FUEL VOL CONSUMPTN (VFC)	INLET MFLD PRES	INLET MFLD TEMP	EXH MFLD TEMP	EXH MFLD PRES	EXH STACK TEMP
RPM	BHP	LB-FT	PSI	LB/BHP-HR	GAL/HR	IN-HG	DEG F	DEG F	IN-HG	DEG F
1,800	2,250	6,555	277	0.345	110.9	90.8	123.7	1,003.7	86.9	750.9
1,700	2,166	6,693	282	0.335	103.6	79.6	122.2	1,068.4	59.7	724.7
1,600	2,141	7,026	296	0.326	100.4	75.7	121.4	1,075.0	55.9	737.4
1,500	2,025	7,090	299	0.315	92.2	68.8	119.1	1,079.4	46.7	760.1
1,400	1,949	7,311	308	0.316	87.8	62.4	117.7	1,130.1	39.8	822.5
1,300	1,328	5,364	226	0.326	61.3	29.4	115.9	1,153.4	21.8	961.6
1,200	934	4,089	173	0.335	44.7	17.4	116.3	1,189.5	12.0	1,023.8
1,100	636	3,038	123	0.344	31.2	8.4	116.7	1,081.2	8.0	946.5
1,000	551	2,992	122	0.345	27.2	5.1	118.0	1,155.8	6.5	940.8
900	485	2,838	120	0.347	24.1	4.6	119.4	1,054.7	5.9	937.5
800	429	2,819	119	0.350	21.4	3.5	121.0	1,044.5	4.5	919.2
700	374	2,806	118	0.355	19.0	2.7	122.5	1,008.1	4.1	883.5

ZONE 1-2

ENGINE SPEED	ENGINE POWER	COMPRESSOR OUTLET PRES	COMPRESSOR OUTLET TEMP	WET INLET AIR VOL FLOW RATE	WET EXH GAS VOL FLOW RATE	WET INLET AIR MASS FLOW RATE	WET EXH GAS MASS FLOW RATE	WET EXH VOL FLOW RATE (32 DEG F AND 29.92 IN HG)	WET EXH VOL FLOW RATE (32 DEG F AND 29.92 IN HG)
RPM	BHP	IN-HG	DEG F	CFM	CFM	LB/HR	LB/HR	FT3/MIN	FT3/MIN
1,800	2,250	84	429.4	5,719.5	13,244.3	24,794.3	23,571.0	5,379.0	5,036.6
1,700	2,166	81	406.4	5,426.1	12,277.2	23,445.2	24,171.0	5,986.7	4,791.3
1,600	2,141	79	392.3	5,120.7	11,639.9	22,024.8	22,728.2	4,789.2	4,485.6
1,500	2,025	71	364.4	4,502.2	10,439.7	19,351.8	19,997.3	4,208.1	3,924.4
1,400	1,949	64	345.7	3,928.7	9,584.3	16,866.5	17,481.3	3,679.1	3,404.7
1,300	1,328	34	254.4	2,465.3	6,599.8	10,566.8	11,021.2	2,317.7	2,126.4
1,200	934	18	182.9	1,714.6	4,826.2	7,309.6	7,623.0	1,600.1	1,464.8
1,100	636	9	135.2	1,245.5	3,309.2	5,279.5	5,498.0	1,157.1	1,062.2
1,000	551	6	121.9	1,071.5	2,824.5	4,529.8	4,719.9	991.6	909.2
900	485	5	113.3	929.5	2,449.2	3,925.5	4,094.0	661.5	789.9
800	429	4	107.3	802.0	2,091.8	3,383.3	3,533.1	745.5	691.0
700	374	3	103.1	697.0	1,739.7	2,886.3	3,028.2	635.8	579.8

ZONE 2-3

ENGINE SPEED	ENGINE POWER	ENGINE TORQUE	BRAKE MEAN EFF PRESS (BMEP)	BRAKE SPEC FUEL CONSUMPTN (BSFC)	FUEL VOL CONSUMPTN (VFC)	INLET MFLD PRES	INLET MFLD TEMP	EXH MFLD TEMP	EXH MFLD PRES	EXH STACK TEMP
--------------	--------------	---------------	-----------------------------	----------------------------------	--------------------------	-----------------	-----------------	---------------	---------------	----------------

<http://tmiweb.car.com/tmi/servlet/TMIDirector?Action=buildtab&ref=kind=RNTMLRe?Num&tab=M...> 12/01/2009

000/0004 mdr 1/10/00 7 000 000 402/000 402/000 402/000 402/000 402/000 402/000 402/000 402/000

MAX Performance Data Display

RPM	BHP	LB-FT	PSI	LB/BHP-HR	GAL/HR	IN-HG	DEG F	DEG F	IN-HG	DEG F
1,800	2,365	6,901	291	0.345	116.5	82.5	124.6	1,125.0	69.3	775.3
1,700	2,313	7,145	302	0.337	111.3	52.9	123.7	1,107.7	54.5	758.2
1,600	2,260	7,419	313	0.330	106.4	61.2	122.5	1,096.5	39.7	750.5
1,500	2,135	7,474	315	0.319	97.2	73.5	120.3	1,090.0	60.1	752.4
1,400	2,068	7,758	327	0.315	93.1	67.9	118.9	1,138.1	49.2	815.7
1,300	1,974	7,975	337	0.313	89.5	51.2	118.7	1,216.5	38.6	819.5
1,200	1,087	4,758	201	0.232	51.6	22.4	116.9	1,249.7	14.0	1,066.9
1,100	636	3,038	128	0.344	31.2	8.4	116.7	1,081.2	3.3	946.5
1,000	551	2,893	122	0.345	27.2	5.1	118.0	1,068.1	5.3	940.8
900	488	2,846	120	0.347	24.1	4.6	116.5	1,057.2	6.3	839.8
800	429	2,819	119	0.350	21.4	3.5	121.0	1,044.3	4.5	819.2
700	374	2,806	118	0.355	19.0	2.7	122.3	1,118.1	4.1	863.5

ZONE 2-3

ENGINE SPEED	ENGINE POWER	COMPRESSOR OUTLET PRES	COMPRESSOR OUTLET TEMP	WET INLET AIR VOL FLOW RATE	WET EXH GAS VOL FLOW RATE	WET INLET AIR MASS FLOW RATE	WET EXH GAS MASS FLOW RATE	WET EXH VOL FLOW RATE (32 DEG F AND 29.92 IN HG)	DRY EXH VOL FLOW RATE (32 DEG F AND 29.92 IN HG)
RPM	BHP	IN-HG	DEG F	CFM	CFM	LB/HR	LB/HR	FT <sup>3</sup> /MIN	FT <sup>3</sup> /MIN
1,800	2,365	86	442.4	5,802.2	13,752.1	25,174.3	25,989.6	5,470.4	5,113.5
1,700	2,313	85	427.1	5,613.6	13,086.5	24,315.9	25,094.9	5,253.3	4,944.7
1,600	2,260	84	409.9	5,326.5	12,282.5	22,963.4	23,708.4	4,990.3	4,666.9
1,500	2,135	76	379.7	4,712.8	10,973.3	20,288.2	20,958.6	4,414.5	4,115.9
1,400	2,068	70	361.9	4,172.4	10,147.0	17,933.7	18,585.4	3,811.3	3,621.0
1,300	1,974	63	349.5	3,593.1	9,500.1	15,468.7	16,095.5	3,366.5	3,109.9
1,200	1,087	23	207.5	1,896.3	5,509.8	8,096.7	8,458.4	1,774.6	1,618.6
1,100	636	9	135.2	1,245.5	3,309.2	5,279.5	5,498.0	1,157.0	1,082.2
1,000	551	6	121.9	1,071.5	2,824.5	4,529.8	4,719.9	991.4	909.2
900	488	5	113.5	930.1	2,454.9	3,828.3	4,097.4	862.5	789.4
800	429	4	107.3	802.0	2,091.8	3,383.3	3,533.1	745.9	681.0
700	374	3	103.1	667.0	1,739.7	2,896.3	3,028.2	626.8	579.6

MAXIMUM LIMIT

ENGINE SPEED	ENGINE POWER	ENGINE TORQUE	BRAKE MEAN EFF PRES (BMEP)	BRAKE SPEC FUEL CONSUMPTN (BSFC)	VOL FUEL CONSUMPTN (VFC)	INLET MFLD PRES	INLET MFLD TEMP	EXH MFLD TEMP	EXH MFLD PRES	EXH STACK TEMP
RPM	BHP	LB-FT	PSI	LB/BHP-HR	GAL/HR	IN-HG	DEG F	DEG F	IN-HG	DEG F
1,800	2,530	7,440	314	0.342	124.4	84.5	125.4	1,178.9	71.9	812.3
1,700	2,550	7,878	332	0.340	123.9	67.6	125.9	1,178.8	71.1	823.5
1,600	2,539	8,335	352	0.336	121.8	90.4	125.1	1,172.1	68.4	811.2
1,500	2,399	8,400	354	0.322	110.3	64.4	123.3	1,151.5	56.2	787.2
1,400	2,305	3,647	365	0.317	104.4	79.0	121.6	1,155.1	50.4	810.1
1,300	2,208	8,922	376	0.317	100.1	73.0	120.8	1,120.0	43.3	894.4
1,200	1,303	5,702	241	0.330	61.4	39.6	117.0	1,181.3	17.2	1,092.1
1,100	899	4,291	181	0.342	43.9	15.3	118.8	1,151.0	10.9	1,123.1
1,000	839	3,355	142	0.347	31.7	5.0	119.4	1,182.0	7.2	1,052.5
900	540	3,151	133	0.350	27.0	5.6	120.7	1,150.8	5.6	1,022.9
800	463	3,035	128	0.354	23.4	4.1	122.1	1,115.5	4.7	977.0
700	398	2,984	123	0.361	20.5	3.1	123.5	1,091.3	4.2	914.1

MAXIMUM LIMIT

ENGINE SPEED	ENGINE POWER	COMPRESSOR OUTLET PRES	COMPRESSOR OUTLET TEMP	WET INLET AIR VOL FLOW RATE	WET EXH GAS VOL FLOW RATE	WET INLET AIR MASS FLOW RATE	WET EXH GAS MASS FLOW RATE	WET EXH VOL FLOW RATE	DRY EXH VOL FLOW RATE
--------------	--------------	------------------------	------------------------	-----------------------------	---------------------------	------------------------------	----------------------------	-----------------------	-----------------------

http://tmiweb.cat.com/tmi/service/TMIDirector?Action=buildtab&refkind=RNTMIRafNum&tab=N... 12/02/2009



ENGINE SPEED	ENGINE POWER	ENGINE TORQUE	BRAKE MEAN EFF PRES (BMEP)	BRAKE SPEC FUEL CONSUMPTN (BSFC)	VOL FUEL CONSUMPTN (VFC)	INLET MFLD PRES	INLET MFLD TEMP	EXH MFLD TEMP	EXH MFLD PRES	EXH STACK TEMP
RPM	BHP	LB-FT	PSI	LB/BHP-HR	GAL/HR	IN-HG	DEG F	DEG F	IN-HG	DEG F
1,800	2,550	7,440	314	0.342	124.4	84.9	125.4	1,173.8	71.9	612.3
1,700	2,550	7,878	322	0.340	123.9	87.9	125.8	1,173.8	71.1	623.5
1,600	2,539	8,395	351	0.336	121.8	80.4	126.1	1,173.1	69.4	611.2
1,500	2,399	8,400	354	0.322	110.3	84.4	123.3	1,131.8	66.1	787.3
1,400	2,305	8,647	353	0.317	104.4	79.3	121.8	1,131.1	60.4	810.1
1,300	2,208	8,922	375	0.317	100.1	73.3	120.8	1,111.0	49.3	894.4
1,200	1,303	5,702	241	0.320	61.4	30.5	117.0	1,121.1	17.2	1,092.1
1,100	899	4,291	161	0.342	42.9	15.3	118.8	1,191.0	10.3	1,123.1
1,000	639	3,355	142	0.347	31.7	8.0	119.4	1,193.0	7.2	1,052.5
900	540	3,151	132	0.350	27.0	5.6	120.7	1,180.8	5.6	1,022.9
800	463	3,039	128	0.354	23.4	4.1	122.1	1,115.8	4.7	977.0
700	398	2,984	126	0.361	20.5	3.1	123.8	1,052.3	4.2	924.1

MAXIMUM POWER CURVE M

ENGINE SPEED	ENGINE POWER	COMPRESSOR OUTLET PRES	COMPRESSOR OUTLET TEMP	WET INLET AIR VOL FLOW RATE	WET EXH GAS VOL FLOW RATE	WET INLET AIR MASS FLOW RATE	WET EXH GAS MASS FLOW RATE	WET EXH VOL FLOW RATE (32 DEG F AND 29.92 IN HG)	DRY EXH VOL FLOW RATE (32 DEG F AND 29.92 IN HG)
RPM	BHP	IN-HG	DEG F	CFM	CFM	LB/HR	LB/HR	FT3/MIN	FT3/MIN
1,300	2,550	88	458.6	5,879.1	14,380.1	25,539.3	26,409.2	5,558.6	5,178.8
1,700	2,550	91	457.4	5,813.2	14,344.5	25,340.5	26,108.6	5,496.3	5,120.3
1,600	2,539	93	451.7	5,711.0	13,924.2	24,738.5	25,591.0	5,387.0	5,019.4
1,500	2,399	87	416.3	5,188.1	12,356.5	22,381.0	23,152.7	4,873.2	4,538.2
1,400	2,305	81	397.6	4,683.2	11,365.9	20,178.4	20,909.3	4,401.2	4,075.6
1,300	2,208	75	383.1	4,087.0	10,620.0	17,820.5	18,321.3	3,856.1	3,546.3
1,200	1,303	31	244.7	2,185.3	6,493.5	9,344.7	9,774.5	2,057.5	1,871.9
1,100	899	16	174.4	1,494.1	4,534.6	6,384.4	6,691.6	1,408.7	1,276.7
1,000	639	8	133.8	1,123.5	3,217.1	4,771.0	4,992.6	1,046.0	950.9
900	540	6	120.2	955.3	2,689.4	4,046.9	4,235.7	891.9	810.7
800	463	4	111.8	814.4	2,227.3	3,443.6	3,606.7	762.2	691.6
700	398	3	106.7	693.4	1,817.0	2,929.1	3,071.1	646.8	584.2

Heat Rejection Data

MAXIMUM LIMIT

ENGINE POWER	REJECTION TO JACKET WATER	REJECTION TO ATMOSPHERE	REJECTION TO EXH	EXHAUST RECOVERY TO 350F	FROM OIL COOLER	FROM AFTERCOOLER	WORK ENERGY	LOW HEAT VALUE ENERGY	HIGH HEAT VALUE ENERGY
BHP	BTU/MIN	BTU/MIN	BTU/MIN	BTU/MIN	BTU/MIN	BTU/MIN	BTU/MIN	BTU/MIN	BTU/MIN
2,550	37,058	6,855	98,283	51,320	14,219	34,131	102,126	255,963	264,383

Emissions Data

Units Filter: All Units

RATED SPEED NOT TO EXCEED DATA: 1800 RPM

ENGINE POWER	BHP	1800	1658	1440	1134	755
PERCENT LOAD	%	130	75	50	25	10
TOTAL NOX (AS NO2)	G/HR	15,405	9,591	9,306	8,323	2,936
TOTAL CO	G/HR	1,321	823	1,494	1,452	1,351
TOTAL HC	G/HR	342	351	350	223	213

PART MATTER		G/HR	200.3	174.4	227.0	181.9	192.5
TOTAL NOX (AS NO2)	(CORR 5% O2)	MG/NM3	3,179.6	2,679.3	3,298.3	3,159.5	3,946.6
TOTAL CO	(CORR 5% O2)	MG/NM3	240.5	213.6	561.1	963.4	1,350.6
TOTAL HC	(CORR 5% O2)	MG/NM3	54.2	93.1	114.0	145.1	322.4
PART MATTER	(CORR 5% O2)	MG/NM3	31.6	38.0	76.2	103.6	173.0
TOTAL NOX (AS NO2)	(CORR 5% O2)	PPM	1,549	1,305	1,654	1,346	1,922
TOTAL CO	(CORR 5% O2)	PPM	192	133	446	772	1,545
TOTAL HC	(CORR 5% O2)	PPM	101	135	213	273	602
TOTAL NOX (AS NO2)		G/HP-HR	5.07	5.08	6.29	5.86	11.51
TOTAL CO		G/HP-HR	0.52	0.48	1.17	1.23	6.20
TOTAL HC		G/HP-HR	0.14	0.21	0.28	0.40	1.19
PART MATTER		G/HP-HR	0.08	0.09	0.18	0.23	0.60
TOTAL NOX (AS NO2)		LB/HR	33.96	21.39	17.65	11.74	6.47
TOTAL CO		LB/HR	2.91	2.04	3.29	3.20	3.49
TOTAL HC		LB/HR	0.76	0.86	0.77	0.38	0.67
PART MATTER		LB/HR	0.44	0.38	0.50	0.40	0.34

**RATED SPEED NOMINAL DATA: 1800 RPM**

ENGINE POWER		BHP	2,550	1,912	1,375	637	255
PERCENT LOAD		%	100	75	50	25	10
TOTAL NOX (AS NO2)		G/HR	12,836	9,076	6,671	4,438	2,446
TOTAL CO		G/HR	734	513	830	607	876
TOTAL HC		G/HR	258	294	263	190	228
TOTAL CO2		KG/HR	1,234	939	624	345	187
PART MATTER		G/HR	143.0	124.6	152.3	129.7	103.7
TOTAL NOX (AS NO2)	(CORR 5% O2)	MG/NM3	2,649.7	2,232.8	2,930.3	3,323.9	3,268.8
TOTAL CO	(CORR 5% O2)	MG/NM3	133.7	127.1	311.7	536.3	1,072.6
TOTAL HC	(CORR 5% O2)	MG/NM3	40.6	62.5	55.7	109.8	242.4
PART MATTER	(CORR 5% O2)	MG/NM3	22.6	27.1	54.5	77.8	123.5
TOTAL NOX (AS NO2)	(CORR 5% O2)	PPM	1,291	1,068	1,379	1,621	1,602
TOTAL CO	(CORR 5% O2)	PPM	107	102	249	429	858
TOTAL HC	(CORR 5% O2)	PPM	76	117	160	203	453
TOTAL NOX (AS NO2)		G/HP-HR	5.06	4.24	5.24	5.96	9.59
TOTAL CO		G/HP-HR	0.29	0.27	0.55	1.17	3.44
TOTAL HC		G/HP-HR	0.10	0.13	0.21	0.30	0.69
PART MATTER		G/HP-HR	0.06	0.07	0.13	0.20	0.43
TOTAL NOX (AS NO2)		LB/HR	28.30	17.80	14.71	9.78	5.39
TOTAL CO		LB/HR	1.62	1.13	1.83	1.73	1.94
TOTAL HC		LB/HR	0.57	0.65	0.58	0.42	0.50
TOTAL CO2		LB/HR	2,720	2,071	1,360	761	413
PART MATTER		LB/HR	0.32	0.27	0.36	0.29	0.24
OXYGEN IN EXH		%	10.8	12.7	13.4	14.1	16.2
DRY SMOKE OPACITY		%	1.1	0.9	2.2	2.2	2.0
BOSCH SMOKE NUMBER			0.41	0.34	0.75	0.76	0.35

**Regulatory Information**

**EPA TIER 2**

2007 - ----

GASEOUS EMISSIONS DATA MEASUREMENTS ARE CONSISTENT WITH THOSE DESCRIBED IN EPA 40CFR PART 94.102 AND ISO 8178 FOR MEASURING HC, CO, PM, AND NOX. THIS ENGINE CONFORMS TO US EPA MARINE COMMERCIAL COMPRESSION-IGNITION EMISSION REGULATIONS.

Locality	Agency	Regulation	Tier/Stage	Max Limits - G/BKW - Hrs
U.S. (INCL CALIF)	EPA	MARINE-COMMERCIAL	TIER 2	CO: 5.0 NOx: 10.0 PM: 0.20

**IMO**

2000 - ----

GASEOUS EMISSIONS DATA MEASUREMENTS ARE CONSISTENT WITH THOSE DESCRIBED IN REGULATION 13 OF ANNEX 1 OF MARPOL 73/78 AND ISO 8178 FOR MEASURING HC, CO, PM, AND NOX. THIS ENGINE CONFORMS TO INTERNATIONAL MARINE ORGANIZATION (IMO) MARINE COMPRESSION-IGNITION EMISSION REGULATIONS.

## D.2 Auxiliary Engine on Conventional Tug

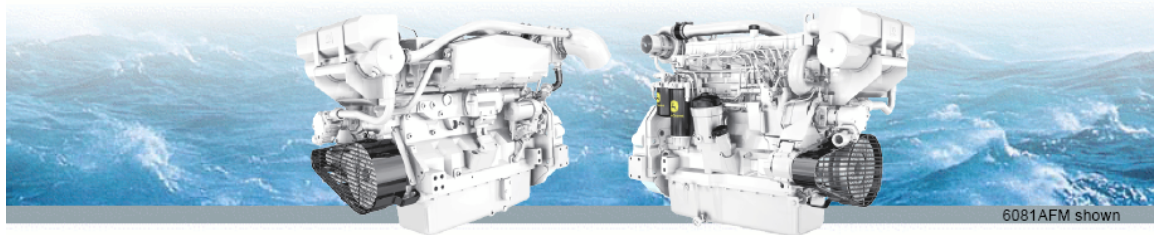


**JOHN DEERE**

PowerTech™

**6081AFM75** Marine Engine

### Auxiliary Specifications



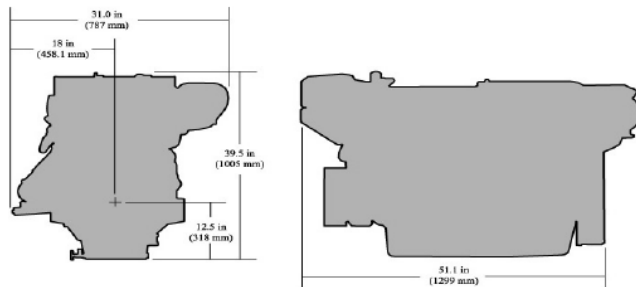
#### General Data

Model	6081AFM75	Length-- mm (in)	1299 (51.1)
Number of cylinders	6	Width-- mm (in)	787 (31.0)
Displacement-- L (cu in)	8.1 (494)	Height, Centerline to Top-- mm. (in)	687 (27.0)
Bore and Stroke-- mm (in)	116 x 129 (4.57 x 5.08)	Height, Centerline to Bottom-- mm. (in)	318 (12.5)
Compression Ratio	15.7:1	Weight, dry-- kg (lb)	853 (1881)
Engine Type	In-line, 4- Cycle	maximum installed Angle	
Aspiration	Aftercooled	Front Up - degrees	12
		Front Down - degrees	0

#### Certifications

- IMO MARPOL Annex VI
- American Bureau of Shipping
- Bureau Veritas
- Det Norske Veritas
- RINA

#### Dimensions



#### Features and Benefits

##### Watercooled Turbocharged and Exhaust Manifold

- Cooler and quieter environment for vessel and crew
- Reduced external connections eliminates hoses and fittings that can leak or break

##### Directed Top-liner Cooling

- Reduces upper liner temperature by as much as 100 degrees Fahrenheit
- Durable and reliable power cylinder components

##### Replaceable Wet-type Cylinder Liners

- Excellent heat dissipation
- Hardened and precision machined for long life
- Rebuild to original specifications

##### Corrosion Resistant Components

- Provides engine protection from the effects of seawater

##### Gear Auxiliary Drive

- Optional auxiliary drive for wash-down pumps, hydraulic oil pumps, and air compressors

##### Heat Exchanger or Keel Cooled

- High-capacity heat exchanger designed for reliable operation in adverse conditions
- Keel cooler option provides application flexibility

##### High Torque and Low Rated RPM

- Enables the engine to turn larger propellers at lower speed for best efficiency
- Excellent vessel control and maneuvering
- Lower rated rpm limits vibration and noise for better crew comfort

##### Fuel System

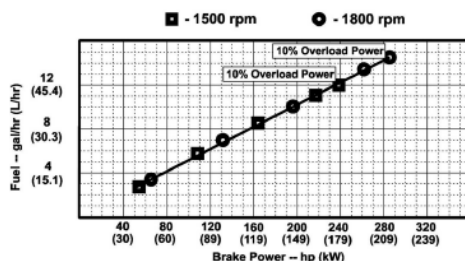
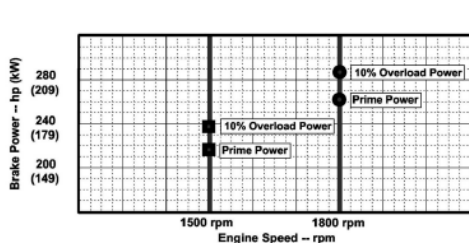
- Electronically controlled high pressure common rail fuel system provides precise fuel delivery with variable timing resulting in excellent fuel economy and excellent performance
- 3-5% Generator Droop Governing
- Self diagnostics and protection
- Electronic instrument panel with plain text messaging

Photographs may show non-standard equipment.

# PowerTech™ 6081AFM75 Marine Engine

## Auxiliary Specifications

### Performance curve



### System Data

	1800 rpm	1500 rpm
<b>Air system</b>		
Engine air flow - m <sup>3</sup> /min (ft <sup>3</sup> /min)	15.7 (554.4)	11.6 (409.7)
<b>Exhaust system</b>		
Dry - mm (in)	100 (3.9)	100 (3.9)
Wet - mm (in)	150 (5.9)	150 (5.9)
<b>Cooling system</b>		
Coolant flow - L/min (gal/min)	216 (57.1)	180 (47.6)
<b>Sea water system</b>		
Pump flow - L/min (gal/min)	163 (43.1)	136 (35.9)
<b>Fuel system</b>		
Governor type	Electronic	Electronic
Governor regulation - %	0-5	0-5
Total fuel flow - L/hr (gal/hr)	325 (85.9)	271 (71.6)

### Performance data

	1800 rpm	1500 rpm
10% overload engine Power - kW (hp)	214 (287.0)	178 (238.7)
Prime engine power - kW (hp)	195 (261.5)	162 (217.2)
Low idle speed - rpm	1100	1100
BMEP - kPa (psi)	0 (0)	0 (0)

### Performance data

Hz (rpm)	Generator Efficiency %	Keel Cooled (no fan)		Power Factor	Calculated Gen-Set Rating	
					kW	kVA
50 (1500)	88-92	--	--	0.8	142-149	178-186
60 (1800)	88-92	--	--	0.8	171-179	214-224



John Deere Power Systems  
3801 W. Ridgeway Ave.  
PO Box 5100  
Waterloo, IA 50704-5100  
Phone: 800.553.6446  
Fax: 319.292.5075

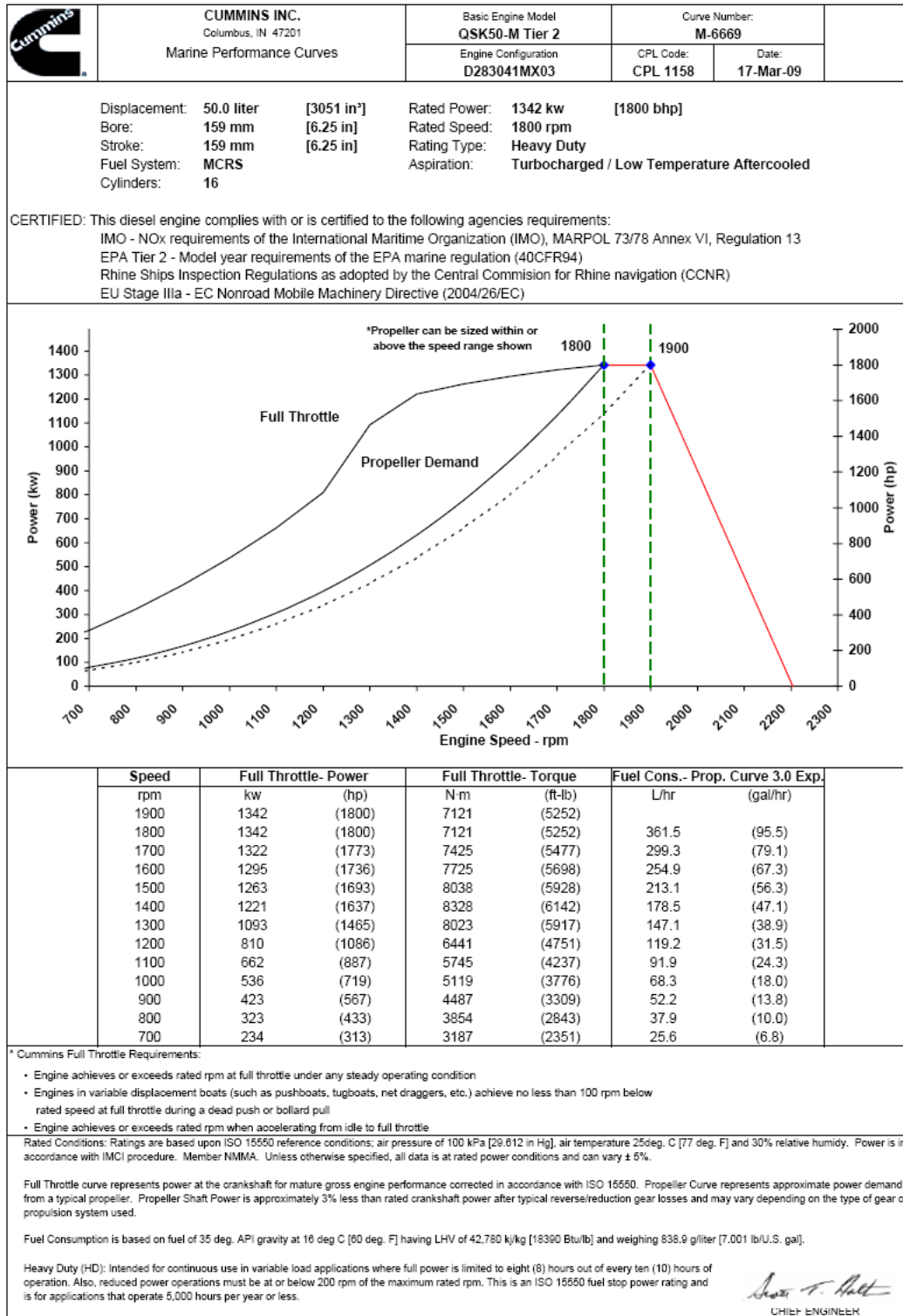
John Deere Power Systems  
Usine de Saran  
La Foulonnerie - B.P. 11.13  
46401 Fleury les Aubrais Cedex  
France  
Phone: 33.2.38.82.61.19  
Fax: 33.2.38.82.60.00

All values at rated speed and power with standard options unless otherwise noted. Specifications and design subject to change without notice.

Litho in U.S.A. (09-08) © 2009 JOHN DEERE



## D.3 Main Engine on Hybrid Tug



## Propulsion Marine Engine Performance Data

**Curve No.** M-6669  
**DS :** D28-MX-1  
**CPL :** CPL 1158  
**DATE:** 17-Mar-09

### General Engine Data

Engine Model .....	QSK50-M Tier 2
Rating Type .....	Heavy Duty
Rated Engine Power .....kW [hp]	1342 [1800]
Rated Engine Speed .....rpm	1800
Rated Power Production Tolerance .....±%	3
Rated Engine Torque .....N-m [lb-ft]	7121 [5252]
Peak Engine Torque @ 1400 rpm.....N-m [lb-ft]	8328 [6142]
Brake Mean Effective Pressure .....kPa [psi]	1790 [260]
Indicated Mean Effective Pressure.....kPa [psi]	N.A. [N.A.]
Maximum Allowable Engine Speed .....rpm	2375
Maximum Torque Capacity from Front of Crank <sup>2</sup> .....N-m [lb-ft]	3165 [2334]
Compression Ratio .....	15:1
Piston Speed .....m/sec [ft/min]	9.5 [1875]
Firing Order .....	2-1-6-5-4-3-10-7-16-15-12-11-14-13-8-9
Weight (Dry) - Engine Only - Average .....	6615 [14584]
Weight (Dry) - Engine With Heat Exchanger System - Average.....	6946 [15313]
Weight Tolerance (Dry) Engine Only .....3xStd Dev(±%)	6.9

### Governor Settings

Default Droop Value.....	Refer to MAB 2.04.00-03/23/2006 for Droop explanation	5%
Minimum Droop Allowed.....		0%
Maximum Droop Allowed.....		16%
High Speed Governor Break Point.....rpm		1900
Minimum Idle Speed Setting.....rpm		650
Normal Idle Speed Variation.....±rpm		10
High Idle Speed Range Minimum.....rpm		1900
High Idle Speed Range Maximum.....rpm		1995

### Noise and Vibration

Average Noise Level - Top (Idle).....	dBa @ 1m	TBD
Average Noise Level - Top (Rated).....	dBa @ 1m	TBD
Average Noise Level - Right Side (Idle).....	dBa @ 1m	TBD
Average Noise Level - Right Side (Rated).....	dBa @ 1m	TBD
Average Noise Level - Left Side (Idle).....	dBa @ 1m	TBD
Average Noise Level - Left Side (Rated).....	dBa @ 1m	TBD
Average Noise Level - Front (Idle).....	dBa @ 1m	TBD
Average Noise Level - Front (Rated).....	dBa @ 1m	TBD

### Fuel System<sup>1</sup>

Avg. Fuel Consumption - ISO 8178 E3 Standard Test Cycle.....	l/hr [gal/hr]	249.0 [66.9]
Fuel Consumption at Rated Speed.....	l/hr [gal/hr]	361.5 [95.5]
Approximate Fuel Flow to Pump.....	l/hr [gal/hr]	780.0 [206.1]
Maximum Allowable Fuel Supply to Pump Temperature.....	°C [°F]	60.0 [140]
Approximate Fuel Flow Return to Tank.....	l/hr [gal/hr]	418.5 [110.6]
Approximate Fuel Return to Tank Temperature.....	°C [°F]	53.3 [128]
Maximum Heat Rejection to Drain Fuel.....	kW [Btu/min]	2.8 [161]
Fuel Pressure - Pump Out/Rail . INSITE Reading.....	kPa [psi]	124994 [18,129]

TBD= To Be Determined

N/A = Not Applicable

N.A. = Not Available

- <sup>1</sup> Unless otherwise specified, all data is at rated power conditions and can vary ± 5%.
- <sup>2</sup> No rear loads can be applied when the FPTO is fully loaded. Max PTO torque is contingent on torsional analysis results for the specific drive system. Consult Installation Direction Booklet for Limitations.
- <sup>3</sup> Heat rejection to coolant values are based on 50% water/50% ethylene glycol mix and do NOT include fouling factors. If sourcing your own cooler, a service fouling factor should be applied according to the cooler manufacturer's recommendation.
- <sup>4</sup> Consult option notes for flow specifications of optional Cummins seawater pumps, if applicable.
- <sup>5</sup> May not be at rated load and speed. Maximum heat rejection may occur at other than rated conditions.

CUMMINS ENGINE COMPANY, INC  
COLUMBUS, INDIANA

All Data is Subject to Change Without Notice - Consult the following Cummins intranet site for most recent data:

<http://marine.cummins.com/>

## Propulsion Marine Engine Performance Data

Curve No. M-6669  
 DS : D28-MX-1  
 CPL : CPL 1158  
 DATE: 17-Mar-09

**Air System<sup>1</sup>**

Intake Manifold Pressure .....	kPa [in Hg]	264 [78]
Intake Air Flow .....	l/sec [cfm]	2199 [4659]
Heat Rejection to Ambient .....	kW [Btu/min]	52 [2974]

**Exhaust System<sup>1</sup>**

Exhaust Gas Flow .....	l/sec [cfm]	4261 [9,029]
Exhaust Gas Temperature (Turbine Out) .....	°C [°F]	327 [621]
Exhaust Gas Temperature (Manifold) .....	°C [°F]	511 [951]

**Emissions (in accordance with ISO 8178 Cycle E3)**

NOx (Oxides of Nitrogen) .....	g/kw-hr [g/hp-hr]	6.53 [4.87]
HC (Hydrocarbons) .....	g/kw-hr [g/hp-hr]	0.16 [0.12]
CO (Carbon Monoxide) .....	g/kw-hr [g/hp-hr]	0.81 [0.61]
PM (Particulate Matter) .....	g/kw-hr [g/hp-hr]	0.09 [0.07]

**Cooling System<sup>1</sup>**

Sea Water Pump Specifications .....	MAB 0.08.17-07/16/2001	
Pressure Cap Rating (With Heat Exchanger Option) .....	kPa [psi]	103 [15]

**Engines with Low Temperature Aftercooling (LTA )**

**Two Loop LTA (For both 1 & 2 pump systems)**


**Main Engine Circuit**

Coolant Flow to Main Cooler (with blocked open thermostat) .....	l/min [gal/min]	2180 [576]
Standard Thermostat Operating Range	Start to open .....	82 [180]
	Full open .....	95 [202]
Heat Rejection to Engine Coolant <sup>8</sup> .....	kW [Btu/min]	721 [41067]

**Aftercooler (LTA) Circuit**

Coolant Flow to LTA Cooler (with blocked open thermostat) .....	l/min [gal/min]	598 [158]
LTA Thermostat Operating Range	Start to open .....	46 [115]
	Full open .....	57 [135]
Heat Rejection to Engine Coolant <sup>8</sup> .....	kW [Btu/min]	385 [21892]
Maximum Coolant Inlet Temperature from LTA Cooler .....	°C [°F]	49 [120]

## D.4 Auxiliary Engine on Hybrid Tug

	<b>CUMMINS INC.</b> Charleston, SC 29405  Marine Performance Curves	Basic Engine Model: <b>QSM11-M</b>	Curve Number: <b>DM-20037</b>	
		Engine Configuration: <b>D353021MX03</b>	CPL Code: <b>8590</b>	Date: <b>20-Mar-09</b>

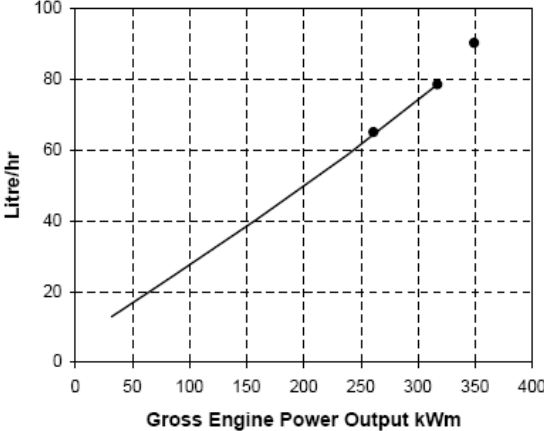
Displacement: <b>10.8 liter [660.00 in<sup>3</sup>]</b> Bore: <b>125 mm [4.92 in]</b> Stroke: <b>147 mm [5.79 in]</b>	Advertised Power: <b>kW [hp] @ rpm</b> <b>317[425]@1800</b>
Fuel System: <b>CELECT</b> Cylinders: <b>6</b>	Aspiration: <b>Turbocharged Aftercooled</b> Exhaust Type: <b>Wet</b>

CERTIFIED: This marine diesel engine complies with or is certified to the:  
 IMO - NOx requirements of the International Maritime Organization (IMO), MARPOL 73/78 Annex VI, Regulation 13  
 EPA Tier 2 - Model year requirements of the EPA marine regulation (40CFR94)


Engine Speed	Overload Capacity		Prime Power		Continuous Power	
RPM	kWm	BHP	kWm	BHP	kWm	BHP
1800	349	468	317	425	261	350

**Engine Performance Data @ 1800 rpm**

OUTPUT POWER			FUEL CONSUMPTION			
%	kWm	BHP	kg/kWh	Lb/ BHP h	Liter/ hour	U.S. Gal/ hour
<b>10% OVERLOAD CAPACITY</b>						
110%	349	468	0.220	0.362	90.4	23.9
<b>PRIME POWER</b>						
100%	317	425	0.211	0.347	78.6	20.8
75%	238	319	0.210	0.345	58.6	15.5
50%	159	213	0.216	0.356	40.4	10.7
25%	79	106	0.247	0.407	23.0	6.1
10%	32	43	0.344	0.567	12.8	3.4
<b>CONTINUOUS POWER</b>						
80%	261	350	0.212	0.349	65.1	17.2



**Rating Conditions:** Ratings are in accordance with ISO 15550 and ISO 8528-5 reference conditions; air pressure at 100 kPa (29.61 in Hg), air temperature 25°C (77°F), and 30% relative humidity. The fuel consumption data is based on No. 2 diesel fuel weight at 0.85 kg/liter (7.1 lb/U.S. gal).  
 Power output curves are based on the engine operating with fuel system, water pump, and lubricating oil pump; not included are battery charging alternator, fan, optional equipment, and driven components.  
 Unless otherwise specified, all data is at rated power conditions and can vary ± 5%.  
**Prime Power Rating** is applicable for supplying continual electrical power at varied load. The following are the Prime Rating parameters:  
 \* Prime Power is available for an unlimited number of hours per year in a variable load application. Variable load should not exceed a 70% average of the Prime Power rating during any operating period of 250 hours.  
 \* The total operating time at 100% Prime Power shall not exceed 500 hours per year.  
 \* There is a 10% overload capability for a period of 1 hour within a 12 hour period of operation. Total operating time at 10% overload shall not exceed 25 hours per year.

TECHNICAL DATA DEPT.   
CHIEF ENGINEER

## Auxiliary Marine Engine Performance Data

Curve No.           DM-20037  
 DS :               DS-3021  
 CPL :              8590  
 DATE:             20-Mar-09

### General Engine Data

	QSM11-M		Overload	
	Prime Power			
Engine Model .....	317	[425]	349	[468]
Rating Type .....				
Rated Engine Power .....		kW [hp]		
Governed Engine Speed .....		rpm		
Rated HP Production Tolerance .....		±%		
Rated Engine Torque .....	1681	[1240]	1851	[1366]
Low Idle Speed Range .....		rpm		
Minimum .....		600		
Maximum .....		800		
Maximum Torque Capacity from Front of Crank <sup>2</sup> .....	813	[600]		
Brake Mean Effective Pressure .....	1953	[283]	2151	[312]
Compression Ratio .....		15.9:1		
Piston Speed .....	9	[1737]		
Firing Order .....		1-5-3-6-2-4		
Friction Power .....	28	[38]		
Steady State Stability Band at Constant Load .....		%		TBD
Weight Dry - Engine Only .....	1118	[2464]		
Weight Dry - Engine With Heat Exchanger .....		[N.A.]		

### Noise and Vibration

Average Noise Level - Top	(Idle).....	dBA @ 1m	80
	(Rated).....	dBA @ 1m	95
Average Noise Level - Right Side	(Idle).....	dBA @ 1m	80
	(Rated).....	dBA @ 1m	95
Average Noise Level - Left Side	(Idle).....	dBA @ 1m	80
	(Rated).....	dBA @ 1m	95

### Fuel System<sup>1</sup>

Approximate Fuel Flow to Pump .....	219.6	[58.0]	219.6	[58.0]
Maximum Allowable Fuel Supply to Pump Temperature .....	60	[140]	60	[140]
Approximate Fuel Flow Return to Tank .....	141.0	[37.2]	129.2	[34.1]
Approximate Fuel Return to Tank Temperature .....	71	[160]	71	[160]
Maximum Heat Rejection to Drain Fuel .....	3	[168]	3	[175]
Fuel Rail Pressure .....	1098	[159]	1100	[160]
Average Fuel Consumption- Emissions ISO 8178 D2 Test Cycle.....	39.2	[10.4]		

### Air System<sup>1</sup>

Intake Manifold Pressure .....	28	[61]	238	[70]
Intake Air Flow .....	401	[849]	443	[939]
Heat Rejection to Ambient .....	29	[1674]	35	[1986]

#### For Air-to-Air Aftercooling (See Radiator Cooling System below)

Intake Air Flow (Mass).....	28	[62]	31	[69]
Compressor Out Temp. @ 1050°F Compressor In Temp.....	179	[354]	201	[394]
Compressor Out Pressure.....	217	[64]	254	[75]
Max. Allowable Pressure Drop Between Compressor Outlet and Intake Manifold Inlet .....	14	[4]	14	[4]
Maximum Intake Manifold Temp.....	60	[140]	60	[140]

### Exhaust System<sup>1</sup>

Exhaust Gas Flow .....	871	[1846]	997	[2113]
Exhaust Gas Temperature (Turbine Out) .....	400	[752]	432	[809]
Exhaust Gas Temperature (Manifold) .....	583	[1080]	635	[1175]
Heat Rejection to Exhaust .....	119	[6780]	144	[8186]

TBD= To Be Determined

N/A = Not Applicable

N.A. = Not Available

- <sup>1</sup> Unless otherwise specified, all data is at rated power conditions and can vary ± 5%.
- <sup>2</sup> No rear loads can be applied when the FPTO is fully loaded. Max PTO torque is contingent on torsional analysis results for the specific drive system. Consult Installation Direction Booklet for Limitations.
- <sup>3</sup> Heat rejection to coolant values are based on 50% water/50% ethylene glycol mix and do NOT include fouling factors. If sourcing your own cooler, a service fouling factor should be applied according to the cooler manufacturer's recommendation.
- <sup>4</sup> Consult option notes for flow specifications of optional Cummins seawater pumps, if applicable.

CUMMINS ENGINE COMPANY, INC  
 COLUMBUS, INDIANA

All Data is Subject to Change Without Notice - Consult the following Cummins intranet site for most recent data:

<http://marine.cummins.com/>

## Auxiliary Marine Engine Performance Data

Curve No.	DM-20037
DS :	DS-3021
CPL :	8590
DATE:	20-Mar-09

### Emissions (in accordance with ISO 8178 Cycle D2)

NOx (Oxides of Nitrogen) .....	g/kw-hr [g/bhp-hr]	6.355	[4.739]
HC (Hydrocarbons) .....	g/kw-hr [g/bhp-hr]	0.251	[0.187]
CO (Carbon Monoxide) .....	g/kw-hr [g/bhp-hr]	0.656	[0.489]
PM (Particulate Matter) .....	g/kw-hr [g/bhp-hr]	0.163	[0.122]

### Emissions (in accordance with ISO 8178 Cycle E2)

NOx (Oxides of Nitrogen) .....	g/kw-hr [g/bhp-hr]	6.289	[4.690]
HC (Hydrocarbons) .....	g/kw-hr [g/bhp-hr]	0.201	[0.150]
CO (Carbon Monoxide) .....	g/kw-hr [g/bhp-hr]	0.362	[0.270]
PM (Particulate Matter) .....	g/kw-hr [g/bhp-hr]	0.134	[0.100]

### Cooling System<sup>1</sup>

Sea Water Pump Specifications .....	MAB 0.08.17-07/16/2001		
Pressure Cap Rating (With Heat Exchanger Option) .....	kPa [psi]	103	[15]

### Engines without Low Temperature Aftercooling (LTA )

#### Sea Water Aftercooled Engines (SWAC)

Coolant Flow to Main Cooler (with open thermostat).....	l/min [gal/min]	233	[61.6]
Standard Thermostat Operating Range	Start to open.....	71	[160]
	Full open.....	80	[175]
Heat Rejection to Engine Coolant <sup>2</sup> .....	kW [Btu/min]	311	[17700]

### Engines with Low Temperature Aftercooling (LTA )

#### Singe Loop LTA

Coolant Flow to Main Cooler (with open thermostat).....	l/min [gal/min]	175	[46.2]
Standard Thermostat Operating Range	Start to open.....	66	[150]
	Full open.....	80	[175]
Heat Rejection to Engine Coolant <sup>2</sup> .....	kW [Btu/min]	269	[15320]

#### Engines with Radiator Cooling & Air-to-Air Aftercooling

Coolant Flow to Radiator (Blocked open thermostat) .....	l/min [gal/min]	220	[58]
Standard Thermostat Operating Range	Start to open.....	71	[160]
	Full open.....	80	[175]
Heat Rejection to Engine Coolant <sup>2</sup> .....	kW [Btu/min]	238	[13562]

## **Appendix E – Fuel Analysis Results**

Conventional Tug Fuel      – Alta June Marine  
 Hybrid Tug Fuel            – Marine Diesel 3/4/10

DATA SUMMARY FOR U.C. Riverside  
 July 20, 2010  
 SWRI WORKORDER #52996

**D 4052 Density (API by Meter) at 60°F**

Sample ID	Alta June Marine	Marine Diesel 3/4/10
API @ 60 F (15.5C)	38.2	38.7
Specific Gravity @ 60 F	0.8338	0.8316
Density @ 15.5C	0.8333	0.8311

**D 2622 Sulfur - Wavelength Dispersive X-Ray Florescence**

Sample ID	Alta June Marine	Marine Diesel 3/4/10
Sulfur, Weight %	0.00092	0.00174
Sulfur, ppm	9.2	17.4

**D 5291 Carbon and Hydrogen**

Sample ID	Alta June Marine	Marine Diesel 3/4/10
Carbon, weight %	86.14	86.02
Hydrogen, weight %	13.56	13.60

No uncertainties have been determined for these results, but ASTM repeatability may be referenced.

The information contained in this document is legally privileged and/or proprietary business information intended only for the use of the individual or the entity named above. If the reader of this document is not the intended recipient, you are hereby notified that any dissemination, distribution, or copy of this document is strictly prohibited. If you have received this document in error, please immediately notify us by telephone at 210-522-3844 and return the original document to the sender at the return address via the United States Postal Service.

Institute shall not publish or make known to others the subject matter or results of the Project or any information obtained in connection therewith which is proprietary and confidential to Client without Client's written approval. No advertising or publicity containing any reference to Institute or any of its employees, either directly or by implication, shall be made use of by Client or on Client's behalf without Institute's written approval. In the event Client distributes any report issued by Institute on this Project outside its own organization, such report shall be used in its entirety, unless Institute approves a summary or abridgement for distribution.